

Blutdruckmessapparate
Blood Pressure Apparatus
Tensiomètres
Esfigmomanoómetros
Sfigmomanometri

02



02.102.00
compl.



Econom
02.110.00
02.112.00
compl.



02.122.00
compl.



02.132.00
compl.

02

Diagnostik
Diagnostics
Diagnostic
Diagnóstico
Diagnostica



COLLIN
02.140.01 Erwachsene · Adult
02.140.02 Kinder · Child · enfant
niños · bambini



FRANCKE
02.145.00



02.147.00



VARIFOCAL
02.160.00

MAY
02.162.00

Diagnostik-Bestecke
Diagnostic Sets
Trousse à diagnostic
Juegos para diagnóstico
Astucci per diagnostica

02



02.170.00
Combination



02.172.00
Universal

02.173.00
Econom Universal



02.174.00
Otoskop - Otoscope - Otoscopio

02

Stirnspiegel, -lampen
Head Mirrors, Head Lights
Miroirs, lampes frontales
Espejos, lámparas frontales
Riflettori, lampade frontali

Stirnlampen
Head Lights
Lampes frontales
Lámparas frontales
Lampade frontali



02.180.91



ZIEGLER
02.180.90
compl.



02.180.92



CLAR
02.190.00
compl.
6 V.



02.190.01



02.195.00
compl.
6 V.



02.195.01



6 Volt
02.199.06

Stethoskope
Stethoscopes
Stéthoscopes
Estetoscopios
Stetoscopi

02



BOWLES
02.240.00

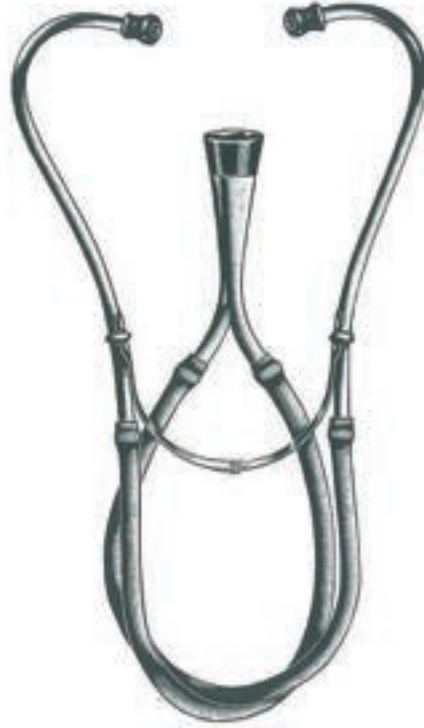

FORD
02.242.00



DUPLEX
02.246.00



FORD-BOWLES
02.244.00



PINARD
02.260.15
15 cm



PINARD
02.262.18
18 cm

02

Perkussionshämmer
Percussion Hammers
Marteaux-percuteurs
Martillos de percusión
Martelli percussori



cm	TAYLOR
17	02.288.17
20	02.288.20



TRAUBE
02.290.16



BABINSKY
02.292.22
22 cm



TROEMNER
02.294.24
24 cm



DEJERINE
02.302.20



DEJERINE
02.304.20



BERLINER
02.306.17

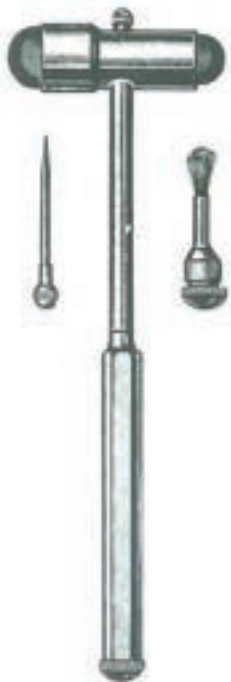

BUCK
02.308.18

Diagnostik
Diagnostics
Diagnostic
Diagnóstico
Diagnostica

Schädel-Messzirkel
Cephalometer
Céphalomètre
Cefalómetro
Cefalometro



BERTILLON
02.310.01

Winkelmesser
Goniometer
Goniomètre
Goniómetro
Goniometro



MOELTGEN
02.312.01

Nadelrad - Pinwheel -
Aesthésiomètre - Sensimetro



WARTENBERG
02.320.19
19 cm

Metal-Meßstäbe
Rulers, metal
Règles en métal
Reglas de metal
Regoli in acciaio



cm	inch.	
10	4	02.340.10
20	8	02.340.20
30	12	02.340.30
50	20	02.340.50



02.344.15
15 cm

Maßband, Stahl
Tape measure, steel
Ruban métrique en acier
Cinta métrica de acero
Nastro metrico di acciaio



02.350.15
1,5 m

04
Aspiration, Anaesthesie
Aspiration, Anesthesia
Aspiration, Anesthésie
Aspiración, Anestesia
Aspirazione, Anestesia



POOLE
04.130.10
10 mm Ø (30Fr.)



POOLE
04.140.08
8 mm Ø (23Fr.)



YANKAUER
04.150.27
27 cm



04.190.25
1/8
04.190.20
1/8
04.190.17
1/8

cm	MAGILL
17	04.190.17
20	04.190.20
25	04.190.25



	McINTOSH	Fig.	McINTOSH	Fig.
Set/3	04.203.00	2-4	Cold Light	2-4
Set/4	04.204.00	1-4		1-4



	FOREGGER	Fig.
	04.223.00	2-4
	04.224.00	1-4

Laryngoskope
Laryngoscopes
Laryngoscopes
Laringoscopios
Laringoscopi

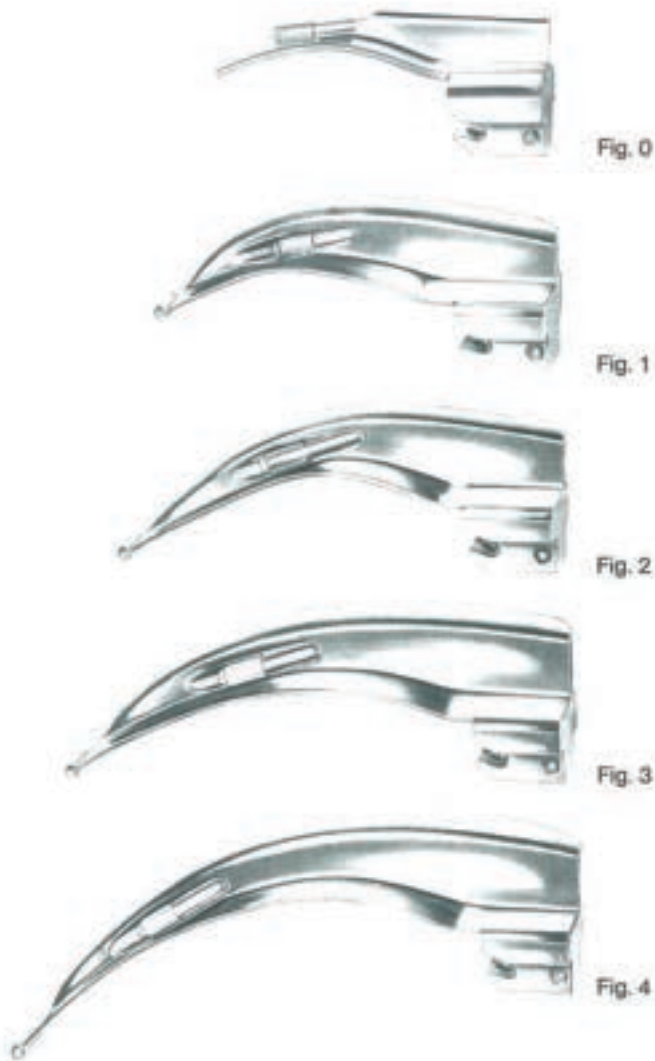

cm	Fig.	normal McINTOSH	Cold Light
5,5	0	04.210.00	04.211.00
7,5	1	04.210.01	04.211.01
9,0	2	04.210.02	04.211.02
11,0	3	04.210.03	04.211.03
13,5	4	04.210.04	04.211.04

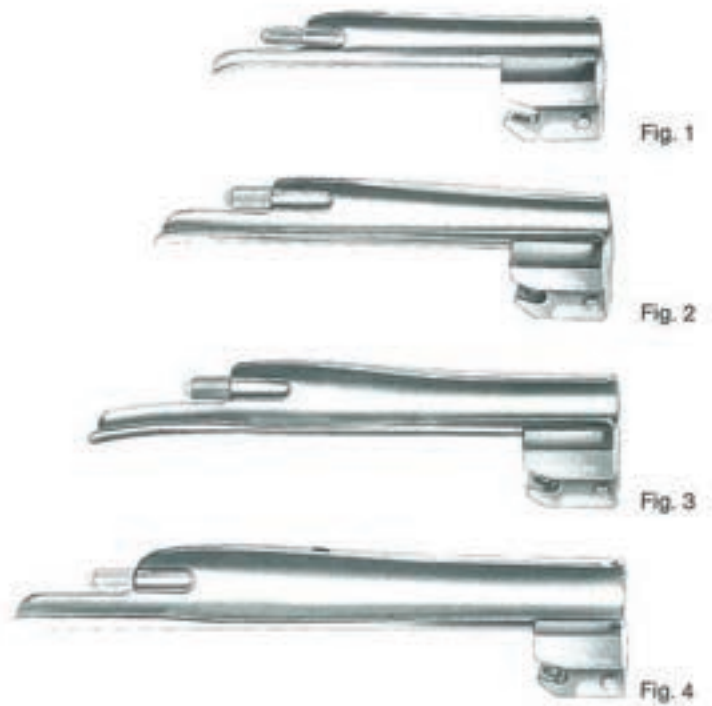

cm	Fig.	FOREGGER
7,0	1	04.220.01
9,0	2	04.220.02
11,0	3	04.220.03
13,5	4	04.220.04



06

Skalpellgriffe
Scalpel Handles
Manches de bistouris
Mangos de bisturios
Manici per bisturi



06.103.00
Fig. 3

06.103.01
Fig. 3 grad.

06.103.02
Fig. 3 L

06.104.00
Fig. 4

06.104.02
Fig. 4 L

06.107.00
Fig. 7

06.107.01
Fig. 7 K

06.108.00
Fig. 8

In Packungen à 100
in packages of 100 ea
en boîtes de 100 pièces
en cajas de 100 c/u
in scatole di 100 pezzi

Skalpellklingen, steril
Scalpel Blades, Sterile
Lames de bistouris, stériles
Hojas de bisturíes estériles
Lame da bisturi, sterili

06



Einmalskalpelle, steril
Disposable Scalpels, Sterile
Bistouris usage unique, stériles
Bisturios uso único, estériles
Bisturi monouso, sterili

in Packungen à 10 Stück
in packages of 10 ea
en boîtes de 10 pièces
en cajas de 10 c/u
in scatole di 10 pezzi

06



06.210.00
Fig. 10



06.211.00
Fig. 11



06.212.00
Fig. 12



06.212.02
Fig. 12d



06.213.00
Fig. 13



06.215.00
Fig. 15



06.215.01
Fig. 15c



06.218.00
Fig. 16



06.219.00
Fig. 19



06.220.00
Fig. 20



06.221.00
Fig. 21



06.222.00
Fig. 22



06.223.00
Fig. 23



06.224.00
Fig. 24



06.225.00
Fig. 25

Klingenbrecher, Rasierklingen
Blade Breakers, Razor Blades
Casse-lames, rasoirs
Rompe-hojas, hojas de afeitar
Pinze rompe-lamette, lamette

06



TROUTMAN-CHRIS
06.290.09
9 cm



DIMEDA
06.291.11
11 cm



CASTROVIEJO
06.294.13
13 cm



06.296.00
Packung = 10
Package = 10 ea
Boîte = 10
Cajita = 10 c/u
Scatola = 10

06

Skalpelle mit Metallheft
Scalpels with Metal Handle
Bistouris, manche métal
Bisturías, mango metálico
Bisturi, manico di metallo



06.402.01 - 06.402.10



06.402.01 Fig. 1 06.402.02 Fig. 2 06.402.03 Fig. 3 06.402.04 Fig. 4 06.402.05 Fig. 5



06.402.06 Fig. 6 06.402.07 Fig. 7 06.402.08 Fig. 8 06.402.09 Fig. 9 06.402.10 Fig. 10



PARKER
06.408.01
Fig. 1



PARKER
06.408.02
Fig. 2

Allgemeine Chirurgie
General Surgery
Chirurgie générale
Cirugía general
Chirurgia generale

Amputationsmesser
Amputating knives
Couteaux à amputation
Cuchillos para amputación
Coltelli per amputazione

Dermatom
Dermatome
Dermatome
Dermátomo
Dermatomo

Resektionsmesser
Resection knives
Couteaux à résection
Cuchillos p. resección
Coltelli per resezione



LANGENBECK
06.410.05
L = 5,5 cm

LANGENBECK
06.412.05
L = 5,5 cm



L = cm	
13	06.420.13
16	06.420.16
19	06.420.19
22	06.420.22
28	06.420.28



L = cm	LISTON
17	06.430.17
20	06.430.20



SCHINK
06.490.00
30 cm compl.



06.490.01



06.490.02

L = Klingenlänge/length
of blade/longueur tranchant/
largo de corte/lunghezza di taglio

06

Allgemeine Chirurgie
General Surgery
Chirurgie générale
Cirugia general
Chirurgia generale



Rasiermesser
Razor
Rasoir
Navaja
Rasoio

06.496.00

Abziehstein
Oil stone
Pierre à repasser
Piedra afiladora
Pietra per affilare



Arkansas
06.499.00



VIRCHOW
06.960.25



Knorpel-, Hirnmesser
Cartilage, brain knife
Couteaux à cartilage, à cerveau
Cuchillo para cartilagos y p. cerebro
Cottelli per cartilagini e per il cervello

L = cm

16	06.980.16
20	06.980.20
24	06.980.24

Chirurgie-Instrumente
Surgical Instruments
Instruments de chirurgie
Instrumentos quirúrgicos
Strumenti per chirurgia

08 Chirurgische Scheren
Operating Scissors
Ciseaux à chirurgie
Tijeras para cirugía
Forbici per chirurgia

TC Schneiden
TC Cutting Edges
Tranchant TC
Filos de corte TC
Taglio TC



cm	Standard	TC	Standard	TC	Standard	TC
10,5	08.102.10		08.110.10		08.120.10	
11,5	08.102.11		08.110.11		08.120.11	
13,0	08.102.13		08.110.13		08.120.13	
14,5	08.102.14	08.104.14	08.110.14	08.114.14	08.120.14	08.124.14
15,5	08.102.15		08.110.15		08.120.15	
16,5	08.102.16	08.104.16	08.110.16	08.114.16	08.120.16	08.124.16
18,5	08.102.18		08.110.18			
20,0	08.102.20		08.110.20			

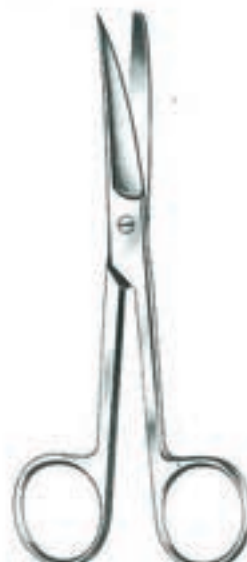

cm	Standard	TC	Standard	TC	Standard	TC
11,5	08.103.11		08.111.11		08.121.11	
13,0	08.103.13		08.111.13		08.121.13	
14,5	08.103.14	08.105.14	08.111.14	08.115.14	08.121.14	08.125.14
15,5	08.103.15		08.111.15		08.121.15	
16,5	08.103.16	08.105.16	08.111.16	08.115.16	08.121.16	08.125.16
18,5	08.103.18		08.111.18			
20,0	08.103.20		08.111.20			

Chirurgische Scheren
Operating Scissors
Ciseaux à chirurgie
Tijeras para cirugía
Forbici per chirurgia

08



08

Präparierscheren
Dissecting Scissors
Ciseaux à dissection
Tijeras de disección
Forbici per dissezione



cm	LEXER		LEXER	
16	08.190.16	08.194.16	08.191.16	08.195.16
21	08.190.21	08.194.21	08.191.21	08.195.21

TC Schneiden
TC Cutting Edges
Tranchant TC
Filos de corte TC
Taglio TC



cm	LEXER	BABY
10	08.202.10	08.203.10
	08.206.10	08.207.10



cm	METZENBAUM		METZENBAUM	
15	08.280.15	08.284.15	08.281.15	08.285.15
18	08.280.18	08.284.18	08.281.18	08.285.18
20	08.280.20	08.284.20	08.281.20	08.285.20
23	08.280.23	08.284.23	08.281.23	08.285.23
25	08.280.25	08.284.25	08.281.25	08.285.25
28	08.280.28	08.284.28	08.281.28	08.285.28
30	08.280.30	08.284.30	08.281.30	08.285.30



cm	METZENBAUM FINO	
15	08.282.15	08.286.15
18	08.282.18	08.286.18
20	08.282.20	08.286.20
23	08.282.23	08.286.23
		08.286.25
		08.286.28

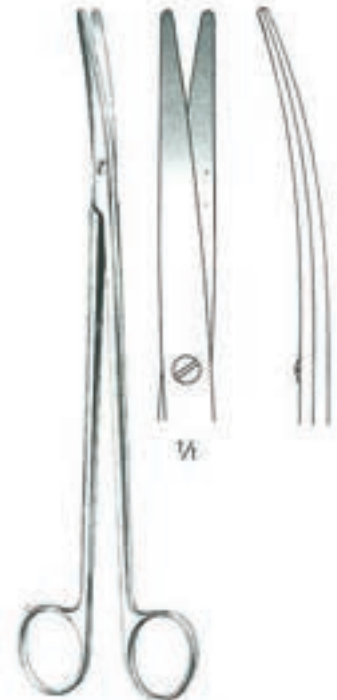

cm	METZENBAUM FINO	
15	08.283.15	08.287.15
18	08.283.18	08.287.18
20	08.283.20	08.287.20
23	08.283.23	08.287.23
		08.287.25
		08.287.28

Chirurgische Scheren
Operating Scissors
Ciseaux à chirurgie
Tijeras para cirugía
Forbici per chirurgia



METZENBAUM "S"
18 cm 08.291.18
08.295.18



SANVENERO
08.302.14 14 cm 08.303.14

Plastik · Plastic · Plastique ·
Plástica · Plastica



JOSEPH
08.304.14 14 cm 08.305.14

Plastik · Plastic · Plastique ·
Plástica · Plastica



KILNER
cm
12 08.310.12 08.314.12
15 08.310.15 08.314.15



REYNOLDS
08.320.15 15 cm 08.321.15
08.324.15 08.325.15

Iris - Standard



Iris - Standard
08.340.09 9 cm 08.341.09
08.340.11 11 cm 08.341.11
08.344.11 08.345.11

08

Scheren, Ophthal., Nase
Scissors, Ophthal., Nasal
Ciseaux, ophtal., nasaux
Tijeras, oftalmología, nasales
Forbici, oftalmologia, nasali



AEBLI
08.347.09 9 cm 08.349.09



STEVENS
11 cm

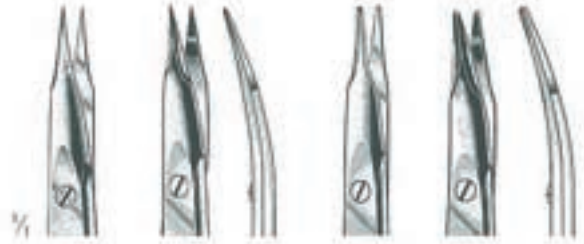

08.360.11 08.361.11 08.362.11 08.363.11

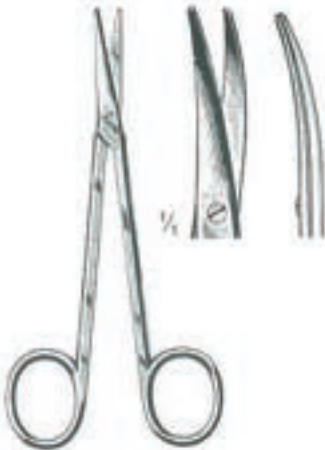

08.370.11 11 cm 08.371.11
08.374.11 08.375.11



08.381.11 11 cm 08.383.11



HEYMANN
08.401.18
18 cm

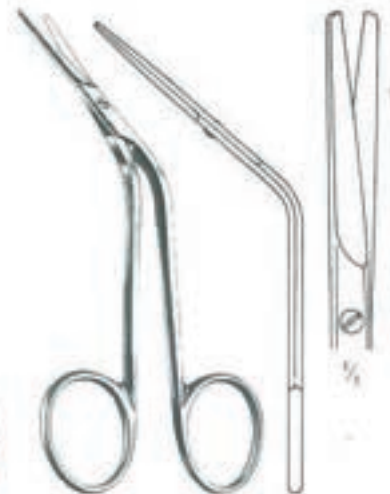

FOMON
08.403.15
15 cm

Tonsillen-, Gefäß-Scheren
Tonsil, Vascular Scissors
Ciseaux amygdal., vasculaires
Tijeras, amígdal., vasculares
Forbici, tonsill., vascolari

Nase - Nasal - Nasale

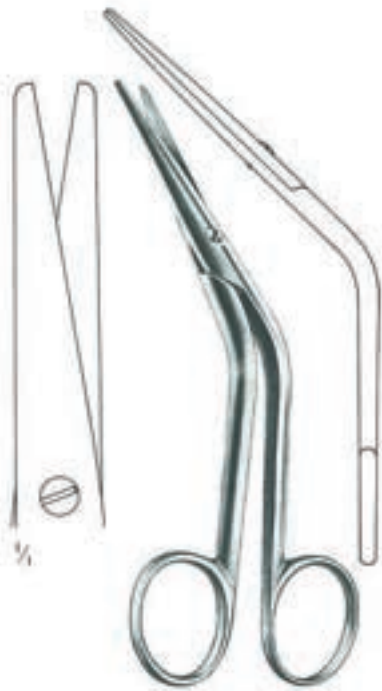

COTTLE
08.405.16
16 cm

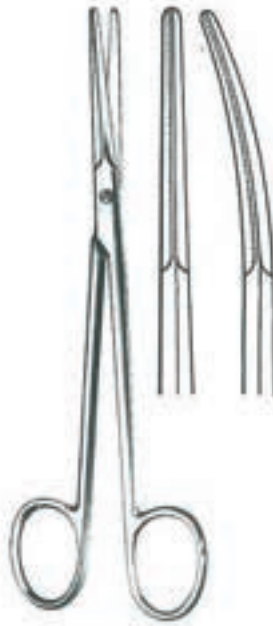

BEUSE	
08.420.14	14 cm
08.420.18	18 cm
08.421.14	14 cm
08.421.18	18 cm



DEAN	
08.425.17	17 cm
08.427.17	17 cm



BOETTCHER
08.435.18
18 cm



GOOD
08.437.19
19 cm



PRINCE
08.439.17
17 cm



08.468.15
15 cm



08.470.11
11 cm

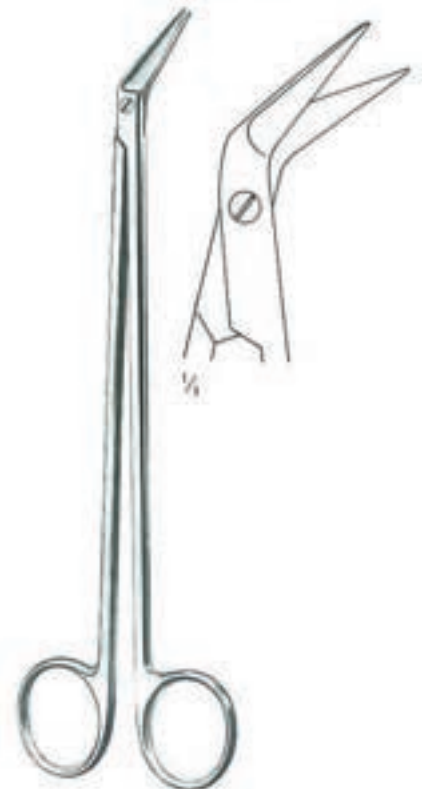

POTTS-DE MARTEL	
cm	
21	08.473.21
24	08.473.24

Gefäß-Scheren
Vascular Scissors
Ciseaux vasculaires
Tijeras vasculares
Forbici vascolari

08

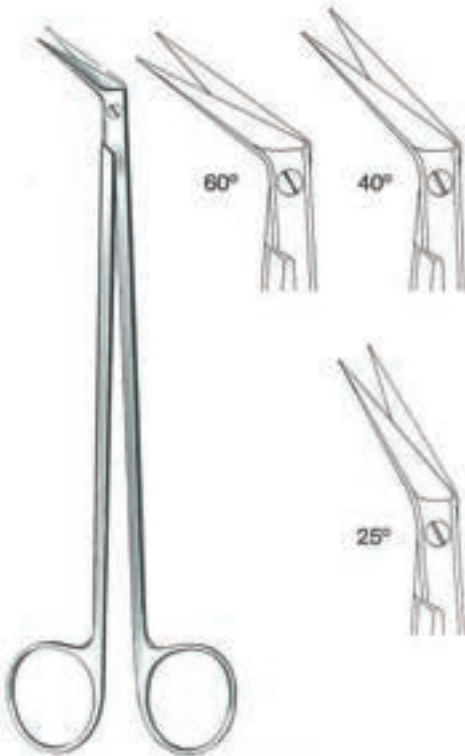

POTTS-SMITH 19 cm		
25°	08.480.25	08.484.25
40°	08.480.40	08.484.40
60°	08.480.60	08.484.60

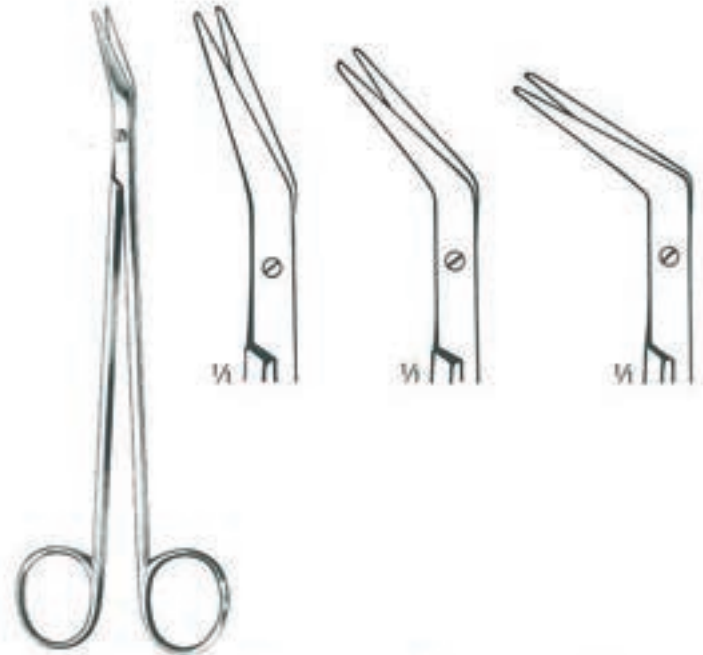

cm	DE BAKEY	25°	45°	60°
16		08.490.16	08.491.16	08.492.16
23		08.490.23	08.491.23	08.492.23
28		08.490.28	08.491.28	08.492.28

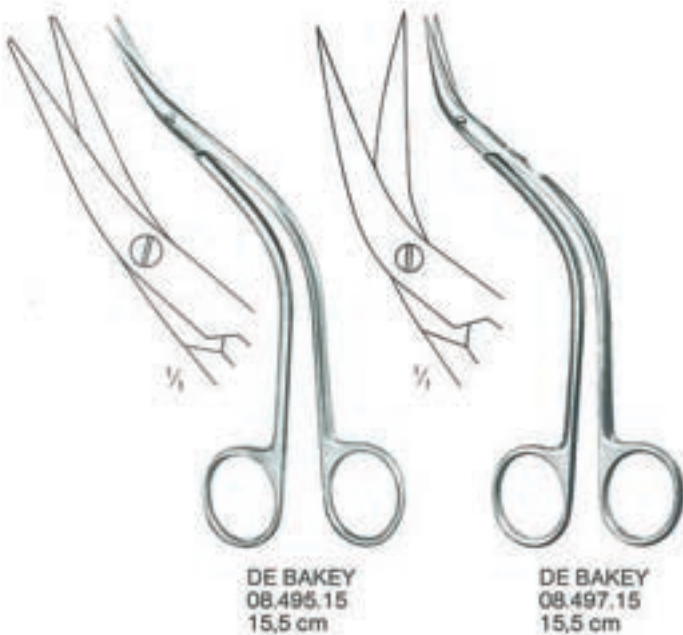

DE BAKEY
08.495.15
15,5 cm

DE BAKEY
08.497.15
15,5 cm

Parametrium - parametrio



08.501.22
08.505.22
22,5 cm

08.501.23
08.505.23
23 cm

08.501.22-08.505.23

Gynäkologische Scheren
Gynaecological Scissors
Ciseaux gynécologiques
Tijeras ginecológicas
Forbici ginecologiche

08

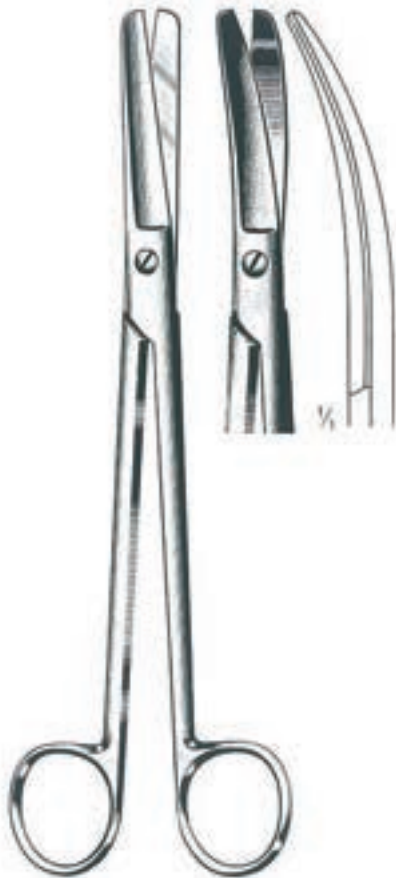

cm	SIMS	
20	08.510.20	08.511.20
23	08.510.23	08.511.23
	08.514.23	08.515.23



SIEBOLD
08.523.24
24 cm

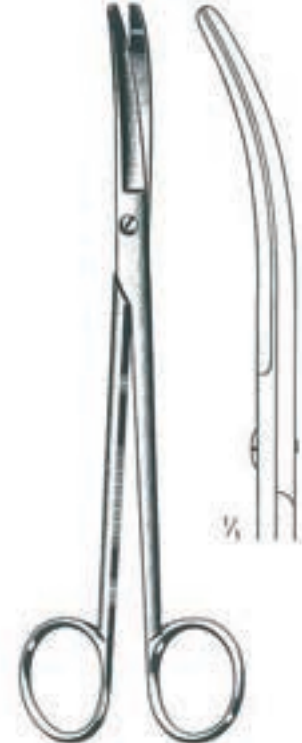

WERTHEIM
08.525.22
22,5 cm

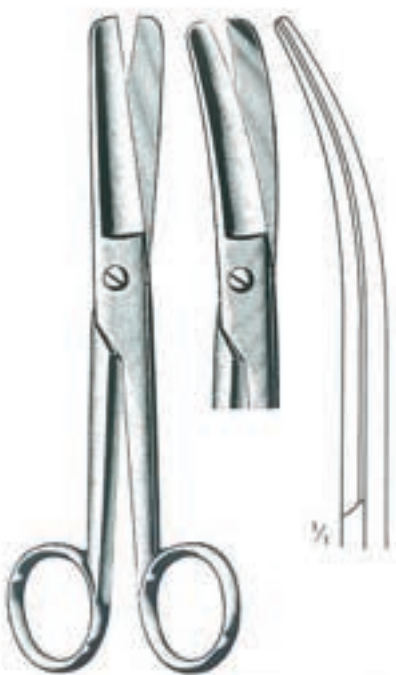

cm	DOYEN	
17,5	08.530.17	08.531.17



cm	DUBOIS	
27	08.536.27	08.537.27



cm	KELLY	
16	08.540.16	08.541.16
18	08.540.18	08.541.18

08

Chirurgische Scheren
Operating Scissors
Ciseaux à chirurgie
Tijeras para cirugía
Forbici per chirurgia

Nabelschnur-Scheren
Umbilical Scissors
Ciseaux ombilicaux
Tijeras umbilicales
Forbici ombelicali



U.S.A. Mod.
08.550.10
10,5 cm



BUSCH
08.551.16
16 cm



SCHUMACHER
08.553.16
14 cm

Episiotomie · Episiotomy ·
Episiotomia



cm	BRAUN-STADLER
14,5	08.560.14
22,0	08.560.22

Neurochirurgie · Neurosurgery ·
Neurocirugia · Neurochirurgia



cm
08.580.11 11 08.581.11

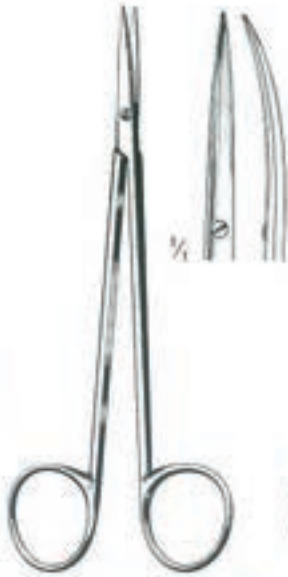

cm
08.582.15 15 08.583.15

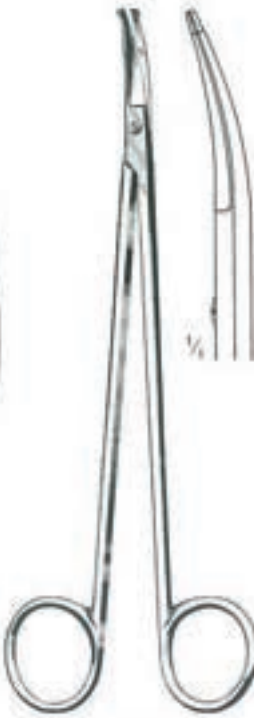

STRULLY
08.601.22
22 cm



TOENNIS-ADSON
08.610.18
18 cm

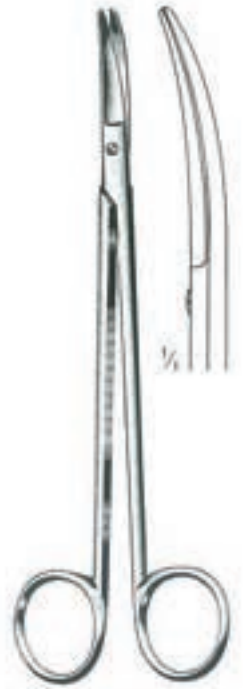

TOENNIS-ADSON
08.611.18
18 cm

Chirurgische Scheren
Operating Scissors
Ciseaux à chirurgie
Tijeras para cirugía
Forbici per chirurgia



McINDOE
08.614.19
19 cm

DANDY
08.617.17
17 cm

SCHMIEDEN-TAYLOR
08.619.17
17 cm

CRAFOORD
08.641.30
30 cm

cm	THOREK
19	08.643.18
25	08.643.25

SATINSKY
08.651.24
24,5 cm

KLINKENBERGH-LOTH
08.661.23
23 cm

08
Chirurgische Scheren
Operating Scissors
Ciseaux à chirurgie
Tijeras para cirugía
Forbici per chirurgia



08.770.21
21 cm



08.772.21
21 cm



08.774.21
21 cm

Darmscheren
Enterotomy Scissors
Ciseaux à entérotomie
Enterótomos
Forbici per enterotomia

Ligaturscheren
Stitch Scissors
Ciseaux à ligatures
Tijeras para puntas
Forbici per legature



SPENCER
08.802.09
9 cm



SPENCER
08.802.11
11 cm



NORTHBENT
08.803.13
13 cm



LITTAUER
08.804.14
14 cm

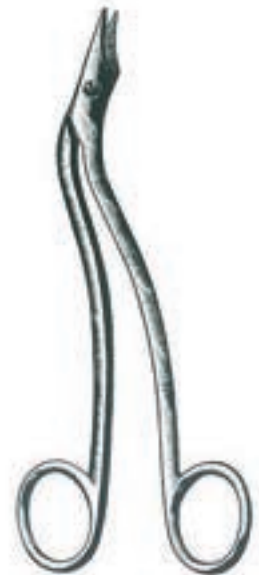

HEATH
08.809.15
15 cm

**Chirurgische Scheren
Operating Scissors
Ciseaux à chirurgie
Tijeras para cirugía
Forbici per chirurgia**

08

**Zahnfleischscheren
Gum Scissors
Ciseaux à gencives
Tijeras para encías
Forbici gengivali**

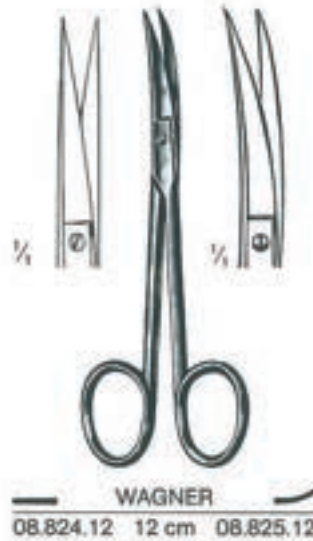

**Draht-, Blechscheren
Wire and plate shears
Ciseaux à fils et plaques métalliques
Tijeras para alambre y chapas
Forbici per filo di metallo e lamiera**

**Gaze
Gauze
Gaza
Garza**



Verband-Scheren
Bandage Scissors
Ciseaux à bandages
Tijeras para vendajes
Forbici per bendaggi



cm	LISTER
11	08.901.11
14	08.901.14
18	08.901.18
	08.905.18
20	08.901.20



BERGMANN
08.911.23
23 cm



cm	ESMARCH
20	08.913.20
22	08.913.22

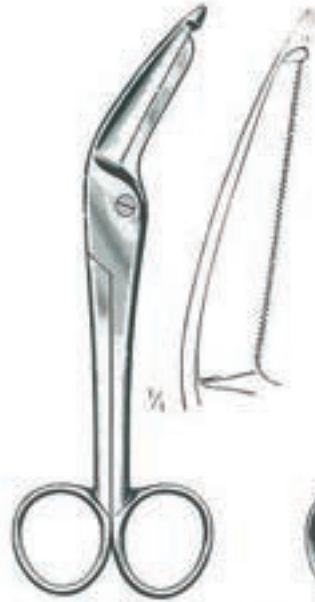

cm	DIMEDA Excenter
16	08.921.16
19	08.921.19



KNOWLES
08.930.14
14 cm



LORENZ
08.933.23
23 cm



	BRUNS
————	08.935.23
-----	08.937.23
	08.939.23
	23 cm



08.941.20
20 cm



cm	UNIVERSAL
15	08.950.15
18	08.950.18

Chirurgie-Instrumente
Surgical Instruments
Instruments de chirurgie
Instrumentos quirúrgicos
Strumenti per chirurgia

09

Augen-Scheren
Ophthalmic Scissors
Ciseaux oculaires
Tijeras oculares
Forbici oculistiche

Sehnen-, Iris-Scheren
Tendon, Iris Scissors
Ciseaux à iris et tendons
Tijeras iris y para tendones
Forbici per iride e tendini



WESTCOTT
09.102.11
11 cm



WESTCOTT
09.104.11
11 cm



NOYES
09.110.12
12 cm



WECKER
09.113.11-09.117.11
11 cm



09.113.11



09.115.11



09.117.11



BARRAQUER
09.119.10
(Colibri) 5,5 cm, 10 mm

Hornhautschere
Corneal scissors
Ciseaux cornéens
Tijeras corneales
Forbici corneali



McGUIRE
09.121.10
10 cm

Iridektomie - Iridectomy
Iridectomia



CASTROVIEJO
09.133.10
10 cm



CASTROVIEJO
09.135.10
10 cm

Augen-, Mikro-Scheren
Ophthalmic, Micro Scissors
Ciseaux oculaires, micro-ciseaux
Tijeras oculares, microquirúrgicas
Forbici oculistiche, micro-chirurg.

09

Iridektomie, Hornhaut
Iridectomy, corneal
Iridectomie, cornéens
Iridectomia, corneal
Iridectomia, corneale



VANNAS
09.140.08
8 cm



VANNAS
09.141.08
8 cm



09.202.18-09.205.18
8 mm Ø



CASTROVIEJO
09.151.11
11 cm



CASTROVIEJO
09.153.11
11 cm



CASTROVIEJO
09.155.11
11 cm

Mikrochirurgie
Micro Surgery
Microchirurgie
Microcirugia
Microchirurgia



09.202.18 18 cm 09.203.18



09.204.14 18 cm 09.205.18 (GYN)

10

Pinzetten
Thumb and Tissue Forceps
Pincès à dissection
Pinzas de disección
Pinze per dissezione

		USA	STILLE			POTTS-SMITH	POTTS-SMITH
cm							
11,5	10.102.11			10.110.11			
12,0		10.104.12					
13,0	10.102.13	10.104.13		10.110.13			
14,5	10.102.14	10.104.14		10.110.14	10.114.14		
15,0			10.106.15				
15,5		10.104.15					
16,0	10.102.16			10.110.16	10.114.16		
18,0	10.102.18	10.104.18				10.112.18	10.116.18
20,0	10.102.20						10.126.18
21,0		10.104.21				10.112.21	10.116.21
25,0	10.102.25	10.104.25				10.112.25	10.116.25
30,0	10.102.30						10.126.25

		USA	STILLE				
cm							
11,5	10.120.11						
12,0		10.122.12					
13,0	10.120.13	10.122.13		10.130.13	10.140.13	10.150.13	10.160.13
14,5	10.120.14	10.122.14		10.130.14	10.140.14	10.150.14	10.160.14
15,0			10.124.15				
15,5		10.122.15					
16,0	10.120.16			10.130.16	10.140.16	10.150.16	10.160.16
18,0	10.120.18	10.122.18			10.140.18		
20,0	10.120.20				10.140.20		
21,0		10.122.21					
25,0	10.120.25	10.122.25			10.140.25		
30,0	10.120.30						

Pinzetten
Thumb and Tissue Forceps
Pincès à dissection
Pinzas de disección
Pinze per dissezione

10

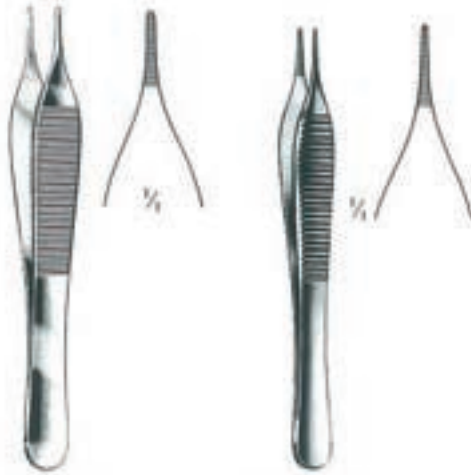

cm	ADSON	ADSON micro
12,0	10.170.12	10.176.12
12,0	10.174.12	
15,0	10.170.15	
15,0	10.174.15	



CUSHING
10.220.17
10.224.17
17 cm

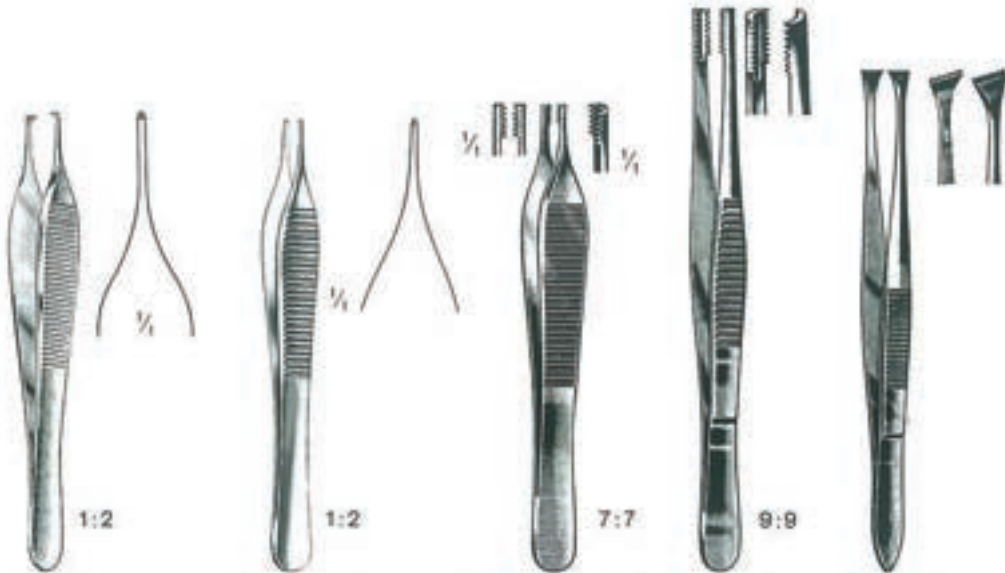

cm	ADSON	ADSON micro	ADSON-BROWN	BROWN	GRAEFE
10,5					10.190.10
12,0	10.180.12	10.186.12	10.188.12		
15,0	10.180.15				
16,0				10.189.16	
20,0				10.189.20	
25,0				10.189.25	



CUSHING
10.230.17
17 cm

Pinzetten
Thumb and Tissue Forceps
Pinces à dissection
Pinzas de disección
Pinze per dissezione

10



cm	SEMKEN	GERALD	GERALD	GERALD
12,5	10.260.12			
15,5	10.260.15			
18,0		10.302.18	10.303.18	10.305.18

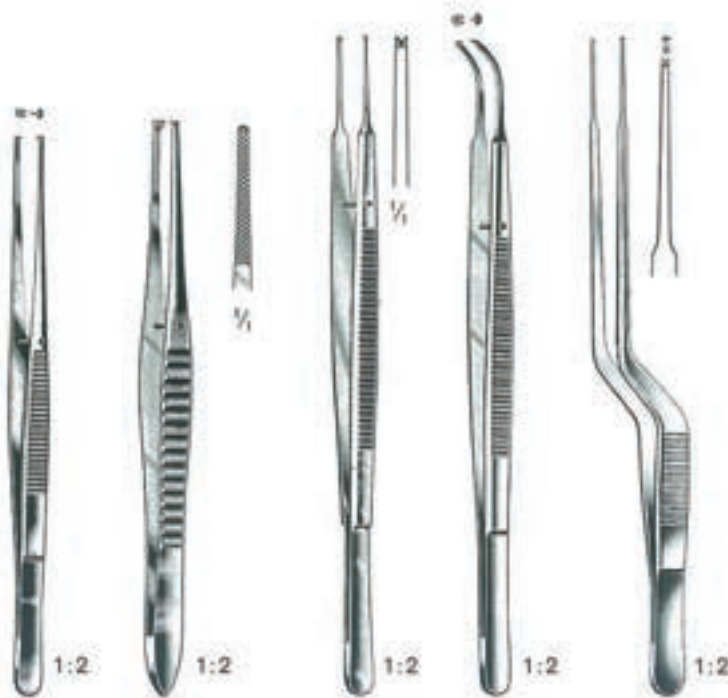

cm	SEMKEN	GILLIES	GERALD	GERALD	GERALD	SINGLEY	NELSON	WANGENSTEEN
12,5	10.270.12							
15,5	10.270.15	10.272.15						
18,0			10.310.18	10.311.18	10.313.18			
23,0						10.320.23	10.322.23	10.324.23

Splitterpinzetten, -zangen
Splinter Forceps
Pincès à échardes
Pinzas para espinas
Pinze per schegge

10

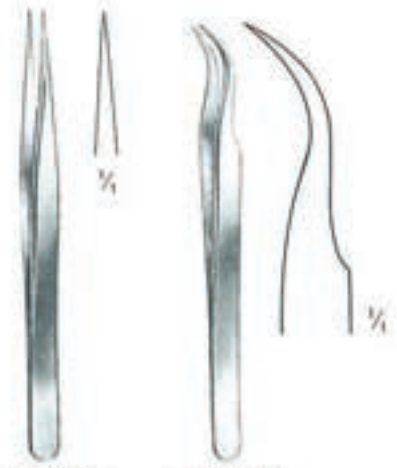

10.330.12
12 cm
Fig. 3

10.331.12
12 cm
Fig. 7



cm		FEILCHENFELD	HUNTER	HUNTER		CARMALT	CARMALT
7,5		10.810.07					
9,0	10.802.09						
10,5			10.812.10	10.813.10		10.816.10	10.817.10
11,5	10.802.11	10.810.11					
12,5					10.815.12		

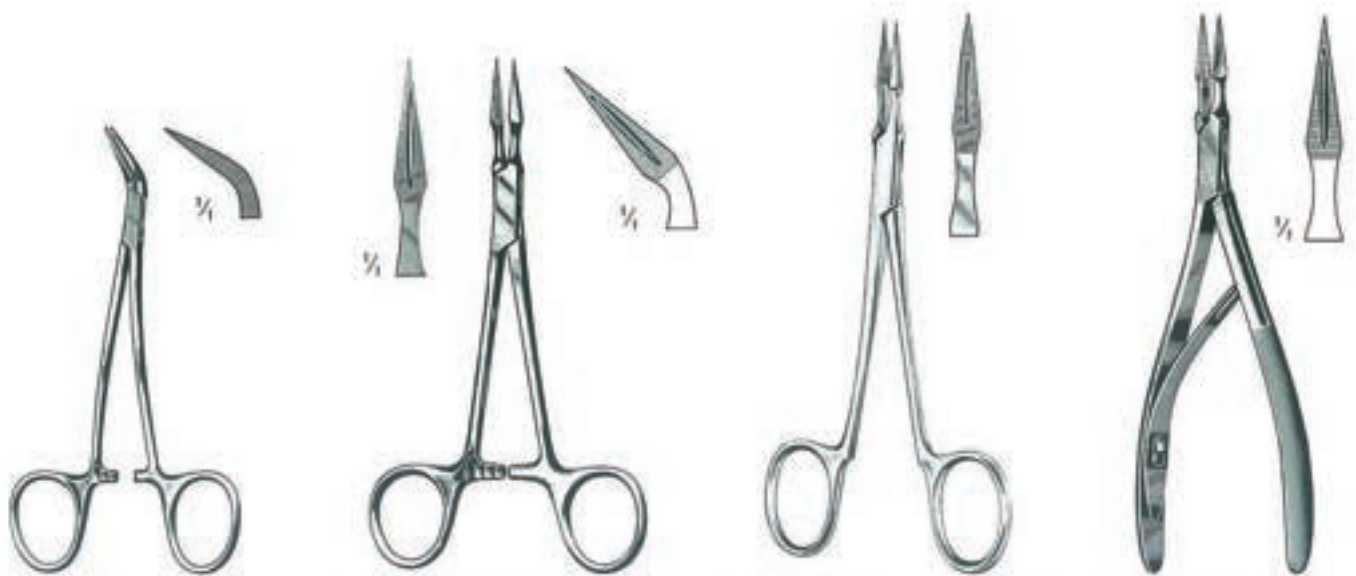

PEET
10.821.11
11,5 cm

STIEGLITZ
10.822.13 13,5 cm 10.823.13

ARCHER
10.824.14 14 cm 10.825.14

VIRTUS (RALK)
10.828.15
15 cm

Mikrochirurgie-Pinzetten
Microsurgery Forceps
Pinces à microchirurgie
Pinzas para microcirugia
Pinze per microchirurgia



11.102.12 12cm 11.103.12



11.104.15 15cm 11.105.15



11.108.18 18cm 11.109.18

11

Atraumatische Pinzetten
Atraumatic Tissue Forceps
Pincés atraumáticas
Pinzas atraumáticas
Pinze atraumatiche

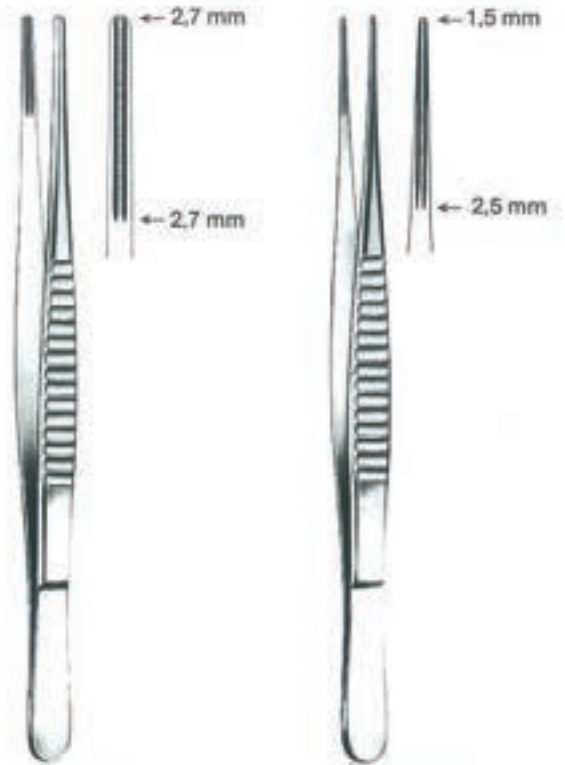

cm	DE BAKEY	DE BAKEY
16	11.304.16	11.306.16
20	11.304.20	11.306.20
24	11.304.24	11.306.24
30	11.304.30	

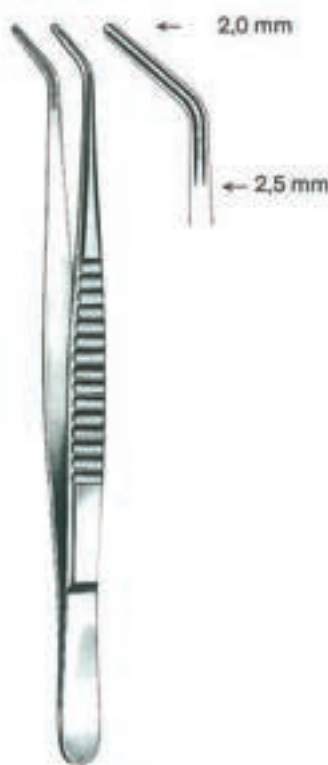

cm	DE BAKEY	DE BAKEY	DE BAKEY	COOLEY
16	11.308.16	11.309.16	11.310.16	11.314.16
20	11.308.20	11.309.20	11.310.20	11.314.20
24	11.308.24	11.309.24	11.310.24	
30	11.308.30	11.309.30	11.310.30	

Atrauma-Bulldogklemmen
Atrauma Bulldog Clamps
Clamps Bulldog Atrauma
Clamps Atrauma Bulldog
Pinze Atrauma Bulldog



DE BAKEY
12.092.07-12.093.12

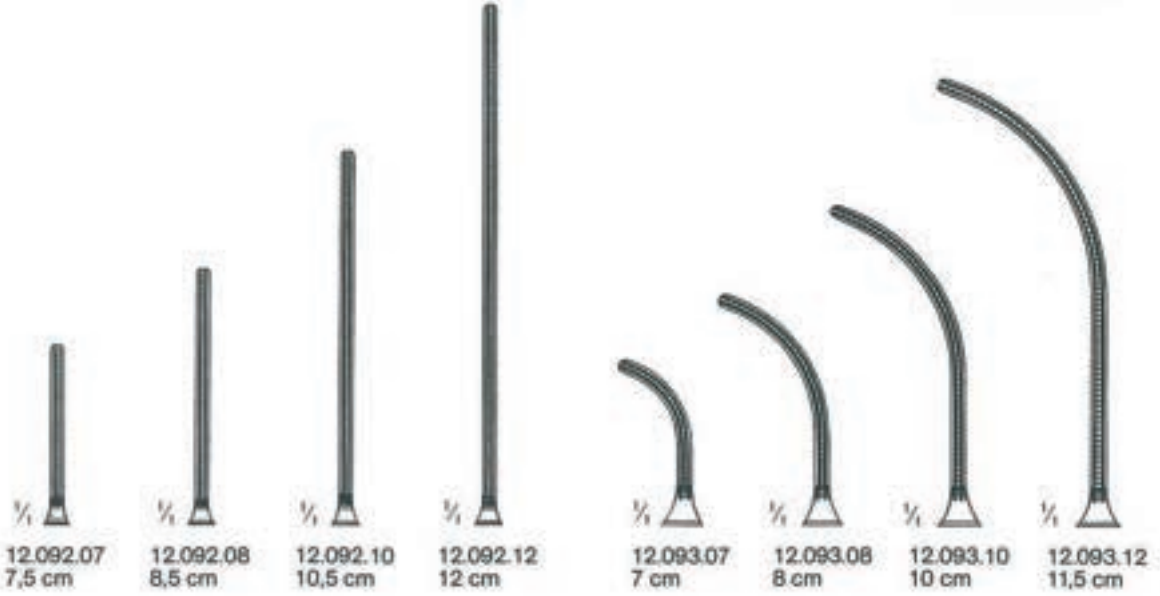

GLOVER
12.096.06-12.097.11

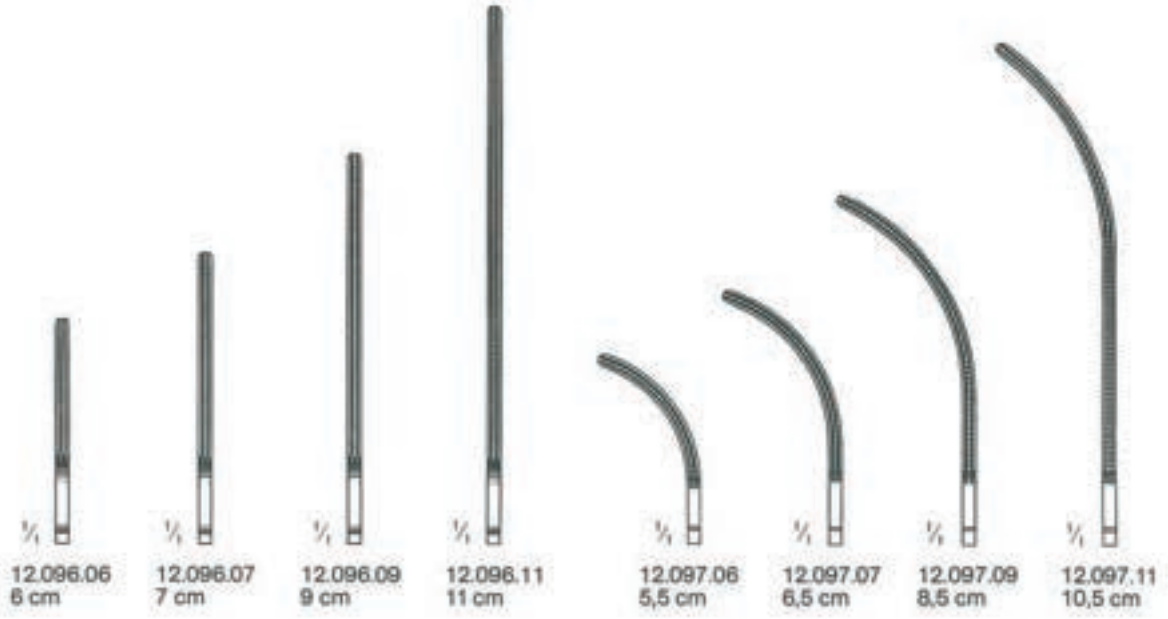

12

Arterienklemmen
Hemostatic Forceps
Pinces hémostatiques
Pinzas hemostáticas
Pinze emostatiche

Gefäßklemmen
Serrefines
Serre-fines
Serra-finas
Serrefine



cm	DIEFFENBACH		JOHNS-HOPKINS	
3,5	12.102.04	12.103.04		
5,0			12.110.50	12.111.50
5,5	12.102.05	12.103.05	12.110.55	12.111.55
6,5			12.110.65	12.111.65
7,0			12.110.70	12.111.70
7,5			12.110.75	12.111.75
9,0			12.110.90	12.111.90



HARTMANN
12.210.10 10 cm 12.211.10



HARTMANN
12.212.10 10 cm 12.213.10

Titan
Titanium
Titane
Titanio

Arterienklemmen
Hemostatic Forceps
Pinces hémostatiques
Pinzas hemostáticas
Pinze emostatiche

12



cm	— HALSTED - MOSQUITO —			— HALSTED - MOSQUITO micro —	
12,5	12.224.12	12.220.12	12.221.12	12.225.12	12.222.12
14,0		12.220.14	12.221.14		12.223.12
18,0		12.220.18	12.221.18		
21,0		12.220.21	12.221.21		

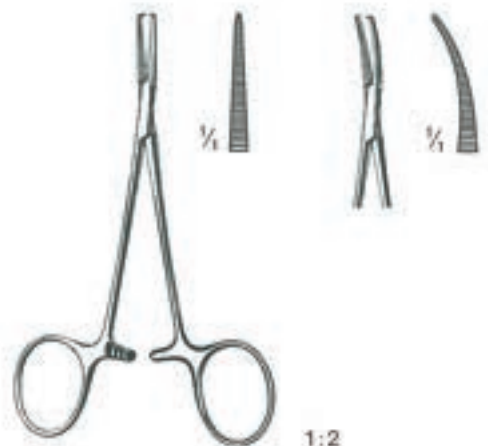

cm	— HALSTED - MOSQUITO —			— HALSTED - MOSQUITO micro —	
12,5	12.234.12	12.230.12	12.231.12	12.235.12	12.232.12
14,0		12.230.14	12.231.14		12.233.12
18,0		12.230.18	12.231.18		
21,0		12.230.21	12.231.21		

12

Arterienklemmen
Hemostatic Forceps
Pinces hémostatiques
Pinzas hemostáticas
Pinze emostatiche

Titan
Titanium
Titane
Titanio

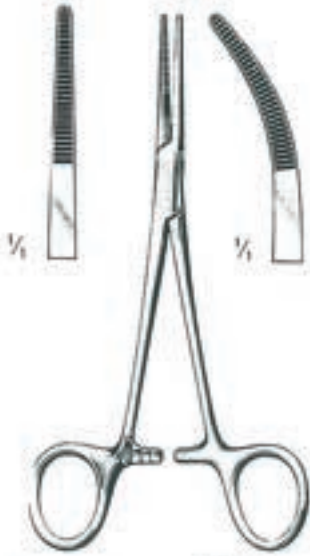

cm — KELY —
14 12.240.14 12.241.14
14 12.244.14 12.245.14
16

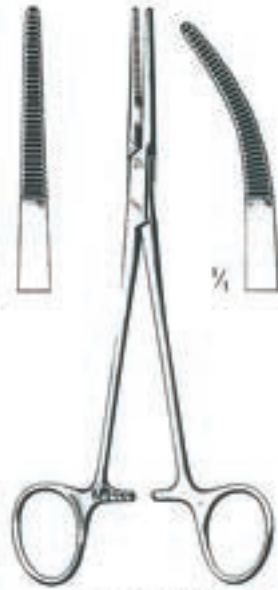

— KELLY-RANKIN —
12.242.16 12.243.16

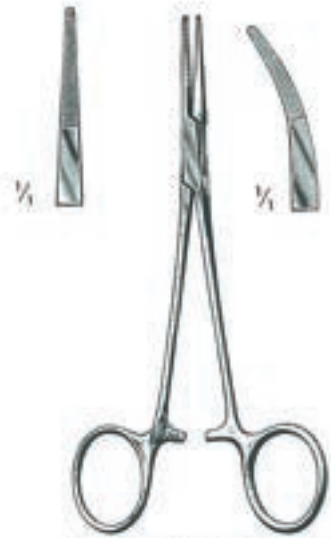

— PROVIDENCE-HOSPITAL —
12.270.14 12.271.14

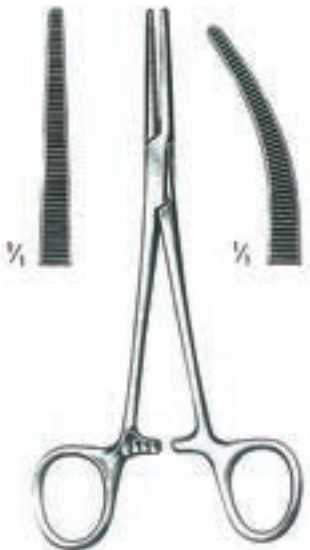

cm — CRILE —
14 12.250.14 12.251.14 12.260.14 12.261.14
14 12.254.14 12.255.14
16

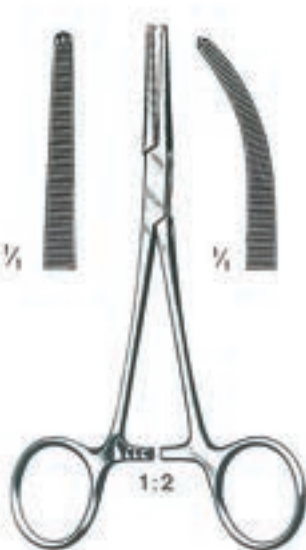

— CRILE —
12.260.14 12.261.14



— CRILE-RANKIN —
12.262.16 12.263.16



— CRILE-RANKIN —
12.264.16 12.265.16

Arterienklemmen
 Hemostatic Forceps
 Pincès hémostatiques
 Pinzas hemostáticas
 Pinze emostatiche

12

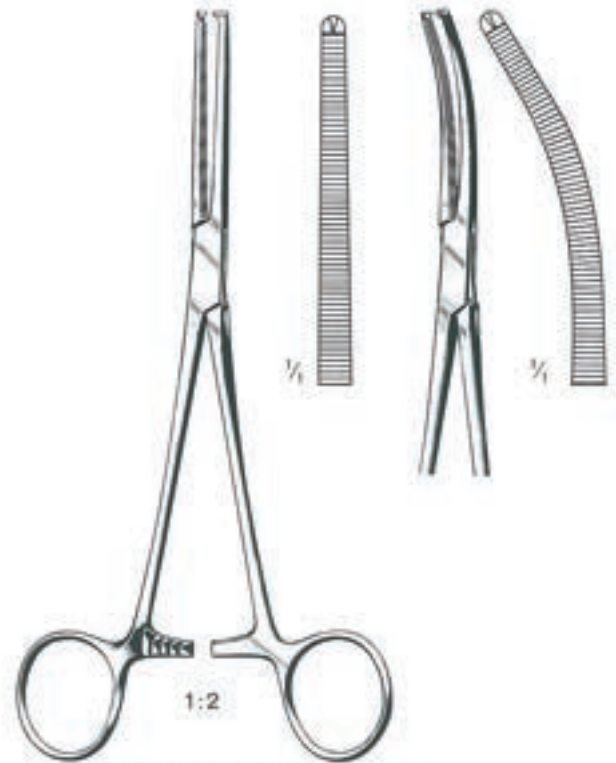

cm	ROCHESTER-PEAN		ROCHESTER-OGHSNER	
13	12.310.13	12.311.13	12.320.13	12.321.13
14	12.310.14	12.311.14	12.320.14	12.321.14
16	12.310.16	12.311.16	12.320.16	12.321.16
18	12.310.18	12.311.18	12.320.18	12.321.18
20	12.310.20	12.311.20	12.320.20	12.321.20
22	12.310.22	12.311.22	12.320.22	12.321.22
24	12.310.24	12.311.24	12.320.24	12.321.24
26	12.310.26	12.311.26	12.320.26	12.321.26
30	12.310.30	12.311.30	12.320.30	12.321.30



Graziles Modell
 Delicate Model
 Modèle délicat
 Modelo delgado
 Modello delicato



Graziles Modell
 Delicate Model
 Modèle délicat
 Modelo delgado
 Modello delicato

PEAN		
12.312.14	14 cm	12.313.14
12.312.16	16 cm	12.313.16

KOCHER		
12.322.14	14 cm	12.323.14
12.322.16	16 cm	12.323.16

12

Arterienklemmen
Hemostatic Forceps
Pinces hémostatiques
Pinzas hemostáticas
Pinze emostatiche



SPENCER-WELLS

12.330.13	13 cm	12.331.13
12.330.15	15 cm	12.331.15
12.330.18	18 cm	12.331.18
12.330.20	20 cm	12.331.20

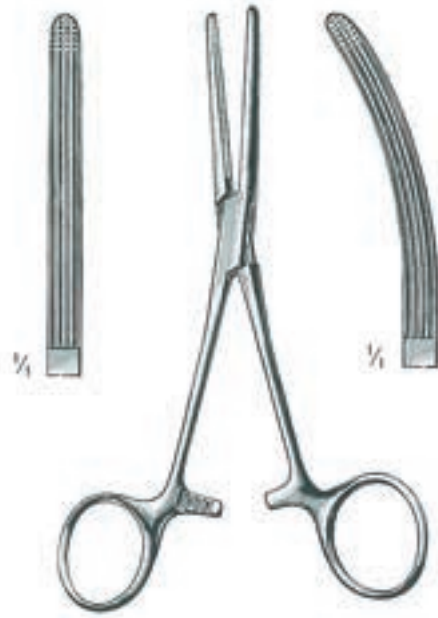

ROCHESTER-CARMALT

12.340.16	16 cm	12.341.16
12.340.20	20 cm	12.341.20

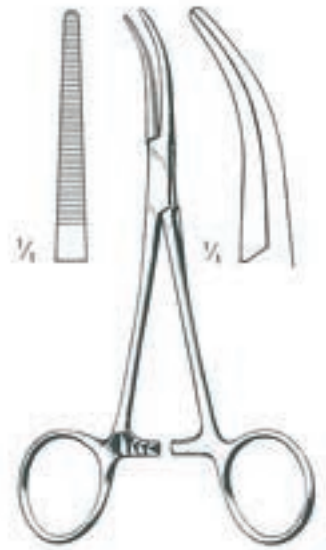

DANDY
12.345.14
14 cm

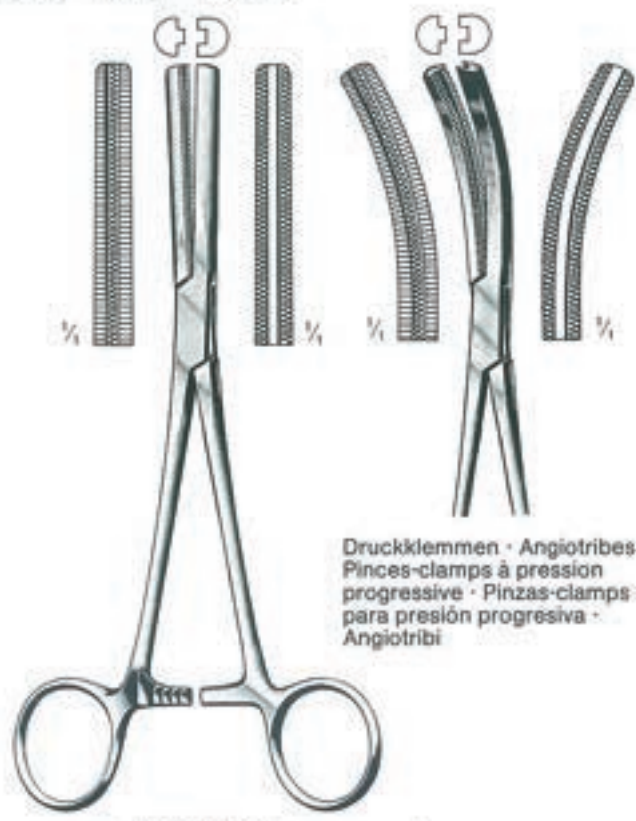

Druckklemmen · Angiotribes
Pinces-clamps à pression progressive · Pinzas-clamps para presión progresiva · Angiotribi

FERGUSSON

12.350.16	16 cm	12.351.16
12.350.20	20 cm	12.351.20

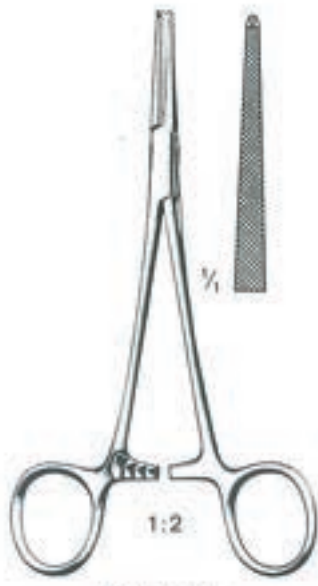

LOVELACE
12.356.15
15,5 cm



PENNINGTON

cm	12.358.15
15,5	12.358.15
20,0	12.358.20

Arterienklemmen
Hemostatic Forceps
Pinces hémostatiques
Pinzas hemostáticas
Pinze emostatiche



PRATT
12.360.15
15 cm



MARTEL
12.364.14
14 cm



WILLET-MARTEL
12.366.19
19 cm

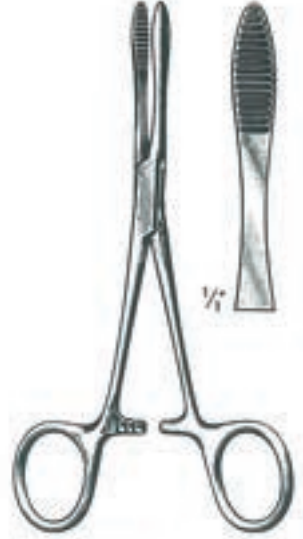

cm	PEAN
14	12.368.14
16	12.368.16



CHAPUT
12.370.13
13 cm



TUFFIER
12.372.13
13 cm



COLLIN
12.374.14
14 cm



COLLIN
12.376.16
16 cm

12

Arterienklemmen
Hemostatic Forceps
Pinces hémostatiques
Pinzas hemostáticas
Pinze emostatiche

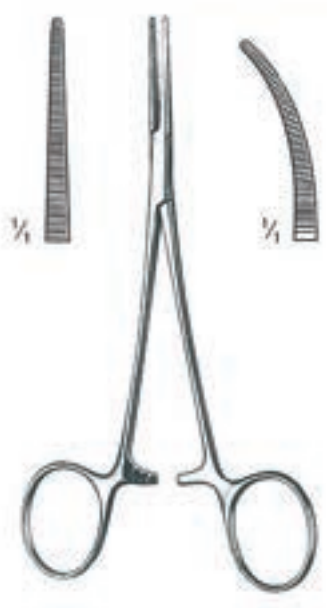

LERICHE
12.380.15 15cm 12.381.15

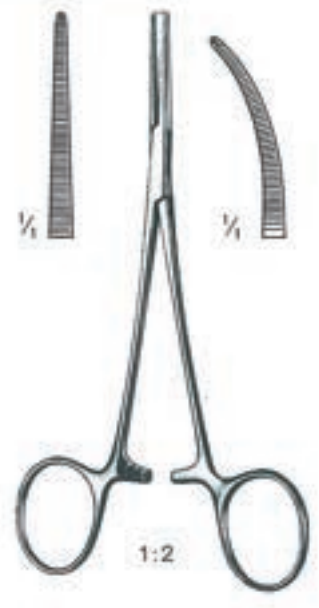

LERICHE
1:2
12.382.15 15cm 12.383.15

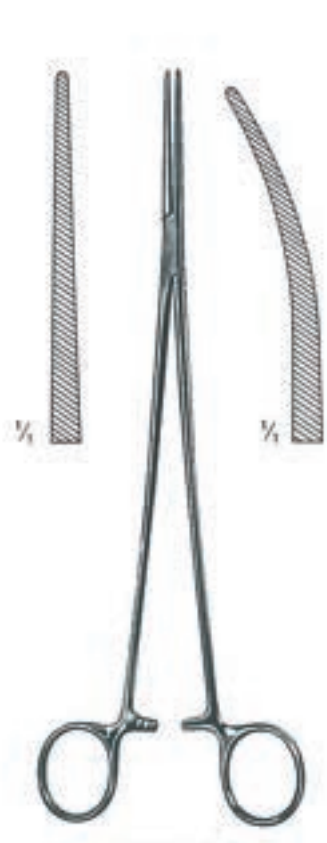

BENGOLEA
12.384.20 20 cm 12.385.20
12.384.26 26 cm 12.385.26

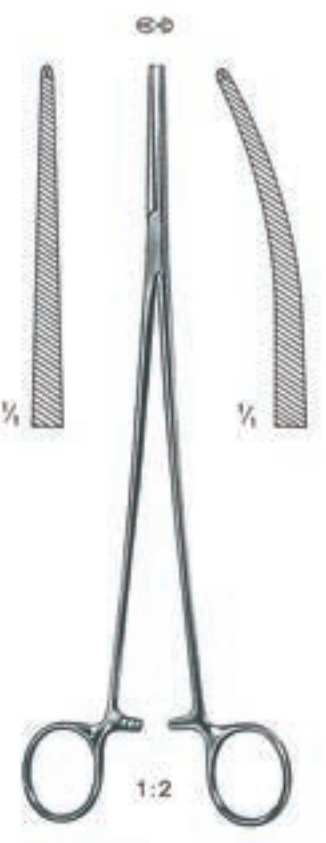

BENGOLEA
1:2
12.386.20 20 cm 12.387.20
12.386.26 26 cm 12.387.26

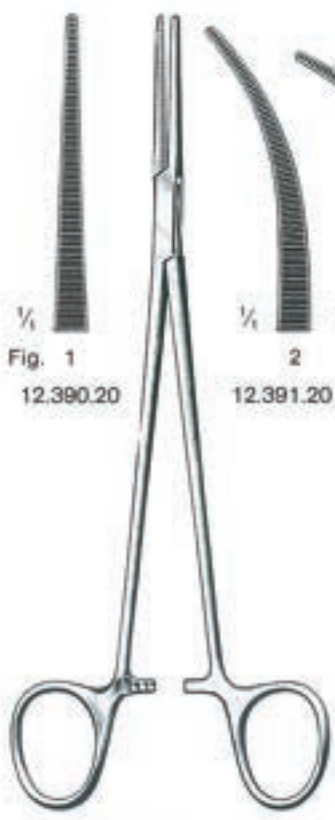

HEISS
20 cm

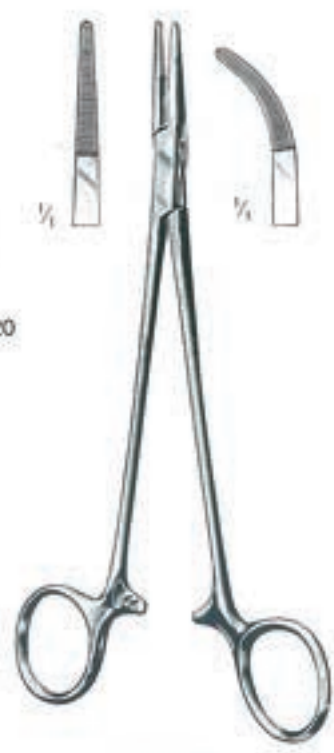

ADSON
12.410.18 18,5cm 12.411.18

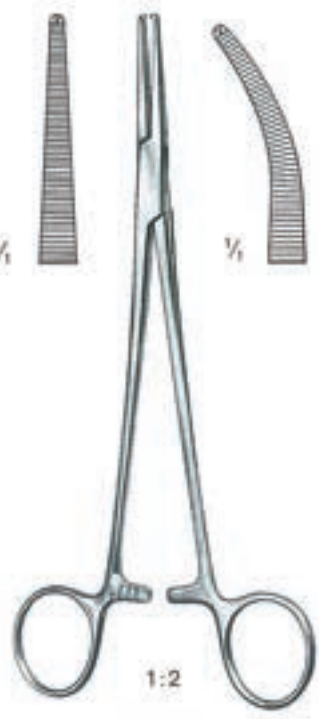

ADSON
1:2
12.412.18 18,5 cm 12.413.18



ADSON Baby
12.415.18

Arterienklemmen
Hemostatic Forceps
Pincès hémostatiques
Pinzas hemostáticas
Pinze emostatiche

12



OVERHOLT-GEISSENDOERFER
12.421.01 - 12.427.08

Präparier- und Ligaturklemmen
Dissecting and Ligature Forceps
Pincès à dissection et à ligatures
Pinzas para disección y ligaduras
Pinze per dissezione e per legature (Passafili)

cm	Fig. 1	Fig. 2	Fig. 3	Fig. 4	Fig. 5	Fig. 6	Fig. 7
21	12.421.01	12.421.02	12.421.03	12.421.04	12.421.05	12.421.06	12.421.07
27	12.427.01	12.427.02	12.427.03	12.427.04	12.427.05	12.427.06	12.427.07



GEMINI
GEMINI mini

GEMINI mini	12.433.18	12.433.22	12.433.25	12.433.28
cm	18	22	25	28

GEMINI	12.431.13	12.431.16	12.431.18	12.431.20	12.431.23	12.431.25	12.431.28
cm	13	16	18	20	23	25	28

12

Arterienklemmen
Hemostatic Forceps
Pinces hémostatiques
Pinzas hemostáticas
Pinze emostatiche



12.441.01



12.441.02



12.441.03



12.441.04



RUMEL
12.441.01 - 12.441.04
23 cm



12.442.21 21 cm
12.442.26 26 cm



21 cm 12.443.21
26 cm 12.443.26



12.444.21 21 cm
12.444.26 26 cm



21 cm 12.445.21
26 cm 12.445.26



TOENNIS
12.442.21 - 12.445.26
21 cm 26 cm



12.448.22



12.449.22

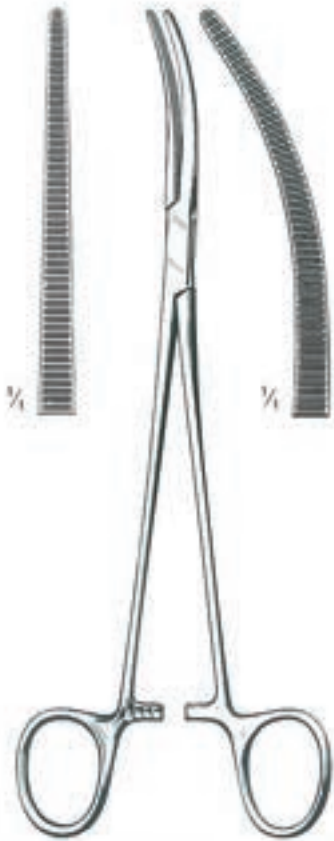

ROBERTS
12.448.22 22 cm 12.449.22

Arterienklemmen
Hemostatic Forceps
Pincés hémostatiques
Pinzas hemostáticas
Pinze emostatiche

12

Bronchusklemmen
Bronchus Forceps
Pincés-Clamps à Bronches
Pinzas clamps bronquiales
Pinze per bronchi

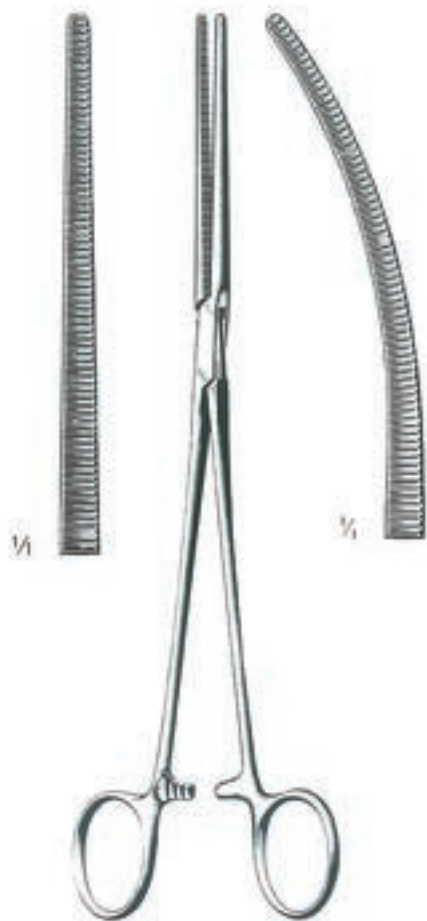

SAROT
12.450.24 24 cm 12.451.24



CRAFOORD
12.453.24
24 cm

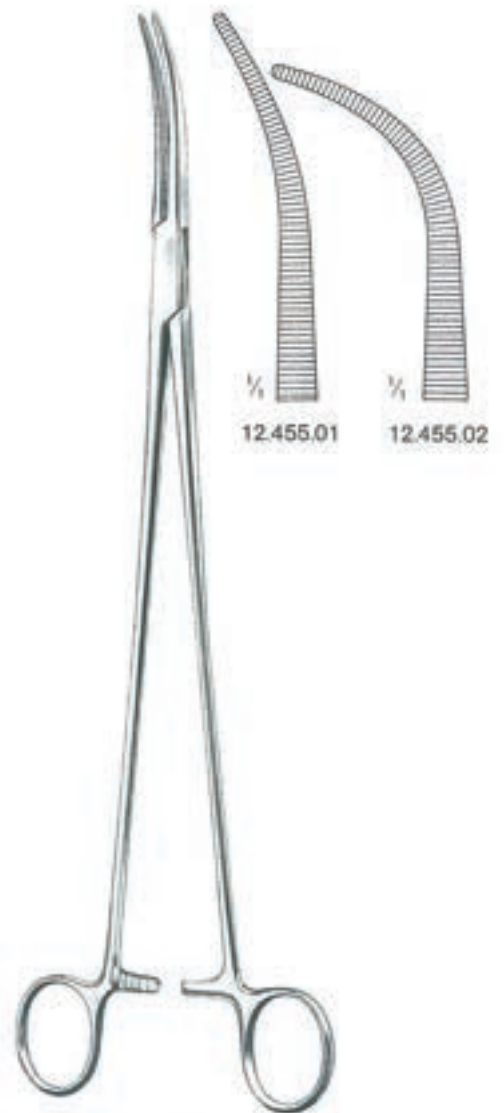

ZENKER
12.455.01 - 12.455.02
29,5 cm

12

Arterienklemmen
Hemostatic Forceps
Pinces hémostatiques
Pinzas hemostáticas
Pinze emostatiche



LAWRENCE
12.457.28
28 cm



MEEKER
12.459.28
28 cm



cm	MIXTER
14	12.471.14
16	12.471.16
18	12.471.18
23	12.471.23



MIXTER
12.473.22
22 cm

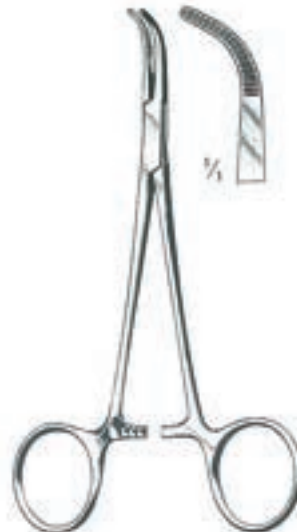

MIXTER Baby
12.475.14
14 cm



MIXTER Baby
12.475.18
18 cm

Arterien, Gallenkanal, Nierenstiel
Hemostatic, Gall Duct, and Kidney Pedicle
Hémostatiques, pédicule rénal et voies biliaires
Hemostáticas, pedículo renal y vías biliares
Emostatiche, pedunculo renale e vie biliari

Arterienklemmen
Hemostatic Forceps
Pinces hémostatiques
Pinzas hemostáticas
Pinze emostatiche



cm	MIXTER-O'SHAUGNESSY
15,5	12.477.15
19,0	12.477.19



MIXTER
12.479.22 - 12.479.28

12.479.22	12.479.25	12.479.28
22 cm	25 cm	28 cm

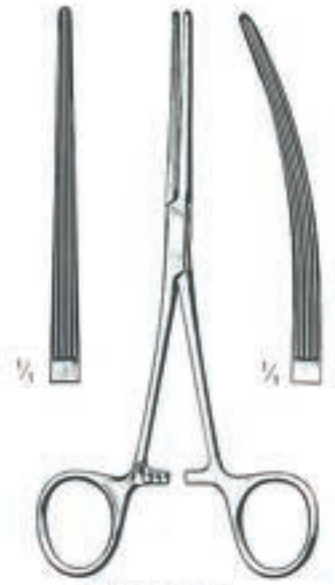

BAINBRIDGE		
12.480.15	15,0 cm	12.481.15
12.480.18	18,5 cm	12.481.18



LAHEY
12.491.19
19 cm



LAHEY
12.493.23
23 cm



LOWER
12.495.18
18 cm

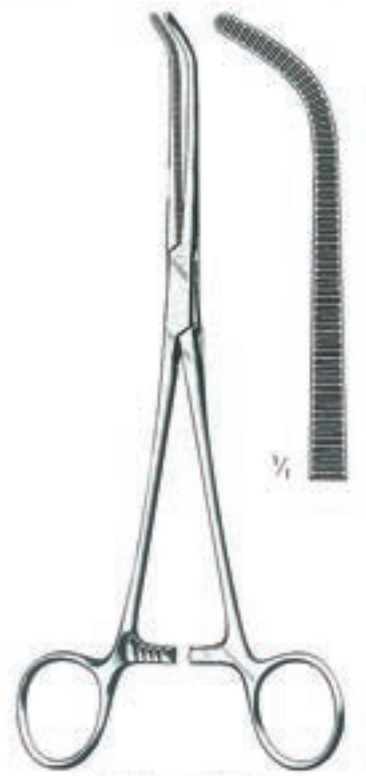

JOHNS-HOPKINS
12.497.20
20 cm

12

Arterienklemmen
Hemostatic Forceps
Pinces hémostatiques
Pinzas hemostáticas
Pinze emostatiche

Gallenkanal - Gall Duct -
Voies biliaires - Vias
bilaires - Vie biliari



MIXTER
12.499.16
16,5 cm



MOYNIHAN
12.501.23
23 cm



DESJARDINS
12.503.21
21 cm
(Cysticus)



DESJARDINS
12.505.21
21 cm



GRAY
Cholecystectomie
12.507.22 22 cm 12.507.23 23 cm



GRAY
12.509.22 22 cm 12.509.23 23 cm

Arterienklemmen
Hemostatic Forceps
Pinces hémostatiques
Pinzas hemostáticas
Pinze emostatiche

Nierenstiel, Gallenkanal
Kidney Pedicle, Gall Duct
Pédicule rénal, conduit biliaire
Pediculo renal, vías biliares
Pedunculo renale, vie biliari



STILLE
12.513.23
23 cm



MAYO-GUYON
12.515.23
23 cm



GUYON
12.517.23
23 cm



GUYON

12.519.20
20 cm

12.519.22
22 cm

12.519.24
24 cm

12

Arterienklemmen
Hemostatic Forceps
Pincès hémostatiques
Pinzas hemostáticas
Pinze emostatiche

Nierenstiel
Kidney Pedicle
Pédicule rénal
Pediculo renal
Pedunculo renale

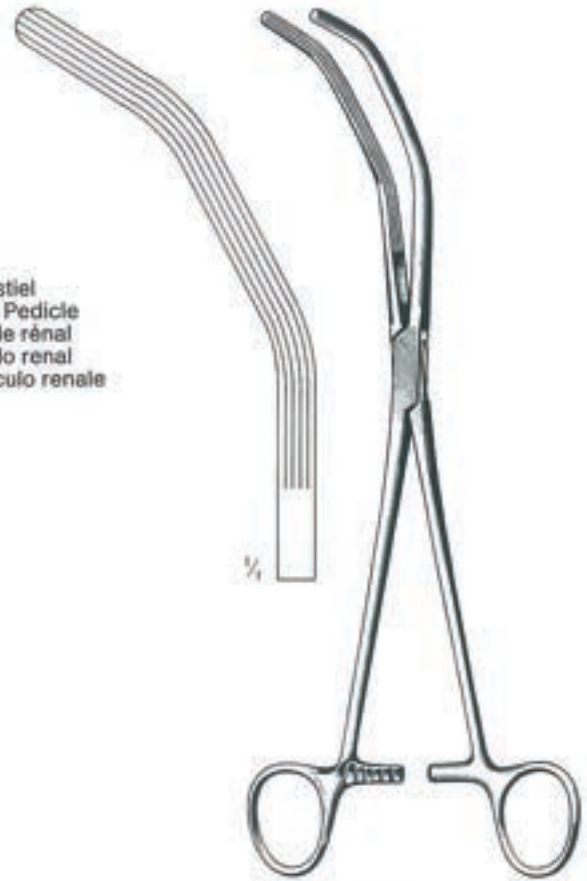

HERRICK
12.523.23
23 cm

Peritoneum-Klemmen
Peritoneum Forceps
Pincès à péritoine
Pinzas para peritoneo
Pinze peritoneali



MIKULICZ
12.551.20
20 cm

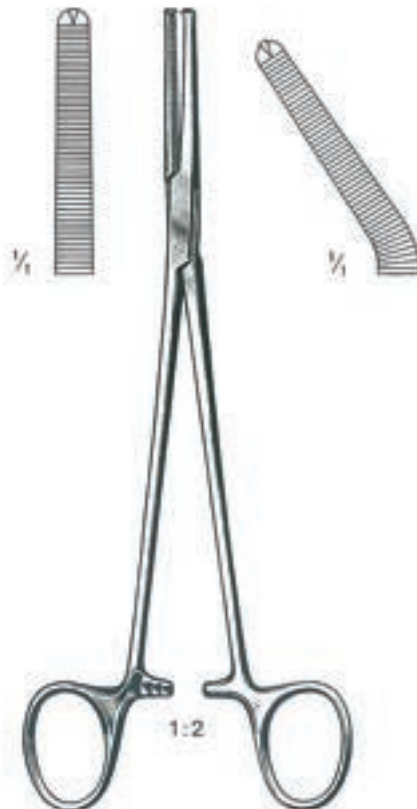

PHANEUF
12.554.21 21 cm 12.555.21

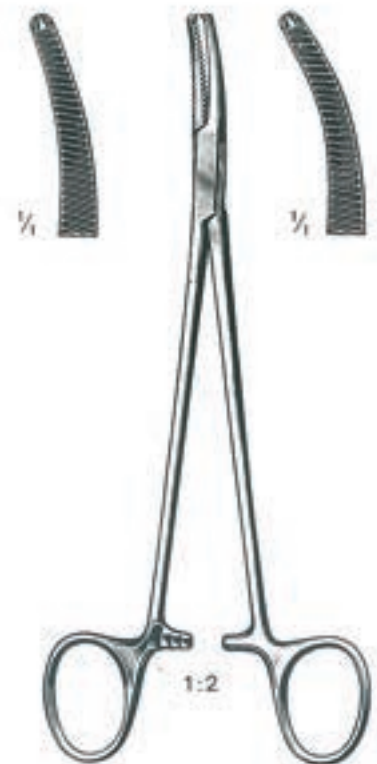

FAURE
12.561.20 20 cm 12.563.20

Hysterektomie-Klemmen
Hysterectomy Forceps
Pincès à hysterectomie
Pinzas para hysterectomía
Pinze per isterectomia

12

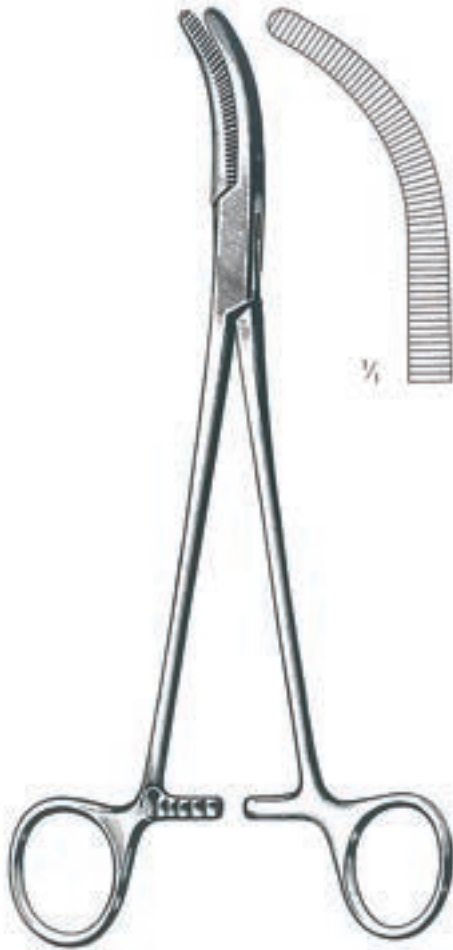

WERTHEIM
12.571.25
25 cm



WERTHEIM
12.573.22 22 cm
12.575.23 23 cm



WERTHEIM-CULLEN
12.579.21
21,5 cm



HEANEY
20 cm 12.591.20 12.593.20

12

Schlauchklemmen
Tubing Clamps
Pincas serre-tubes
Pinzas cierra-tubos
Pinze serretubi

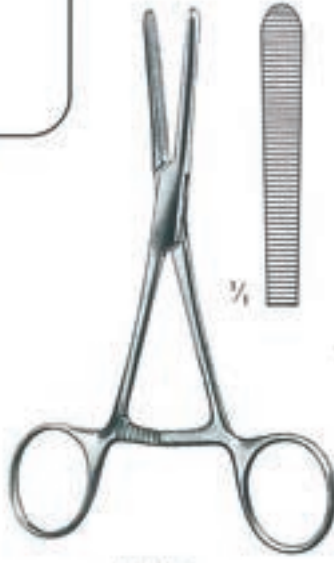

WEISS
12.702.14
14,5 cm



PRESBYTERIAN HOSPITAL
12.704.16 16 cm
12.704.18 18 cm



MURPHY
12.710.15 - 12.710.20



12.710.15
15 cm



12.710.18
18 cm



12.710.20
20 cm



12.712.15 - 12.712.20



12.712.15
15 cm



12.712.18
18 cm



12.712.20
20 cm

Tuchklemmen
Towel Forceps
Pinces à champs
Pinzas para campos
Pinze fissateli



SCHAEDEL
14.101.09
9 cm



JONES
14.103.09
9 cm



JONES-CLIP
14.105.09
9 cm

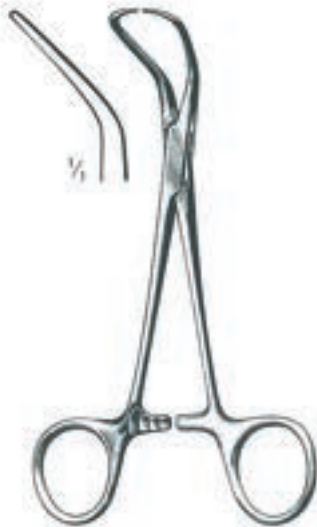

cm	BACKHAUS
9	14.111.09
11	14.111.11
13	14.111.13
15	14.111.15



BACKHAUS-CLIP
14.115.11
11 cm



ROEDER
14.117.13
13 cm



cm	LORNA
11	14.121.11
13	14.121.13



Ball and Socket
14.123.13
13 cm



BERNHARD
14.140.16
16,5 cm



MOYNIHAN
14.150.19
19 cm



DOYEN
14.161.18
18 cm



cm	LANE
13	14.164.13
15	14.164.15
20	14.164.20

Tupferzangen
Dressing Forceps
Pincès à pansements
Pinzas para taponés
Pinze per medicatura

Korn- und Polypenzangen
Dressing and Polypus
à polypes et à pansements
para pólipos
per tamponi e polipi

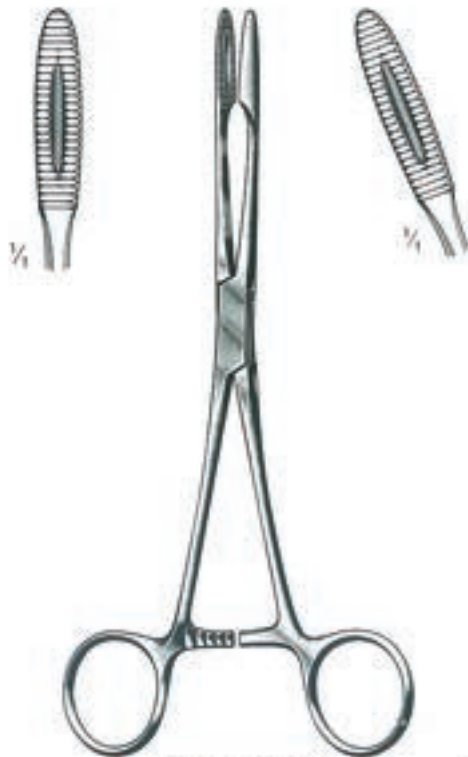

GROSS-MAIER		
16.110.20	20 cm	16.111.20
16.110.22	22 cm	16.111.22
16.110.25	25 cm	16.111.25
16.110.27	27 cm	16.111.27

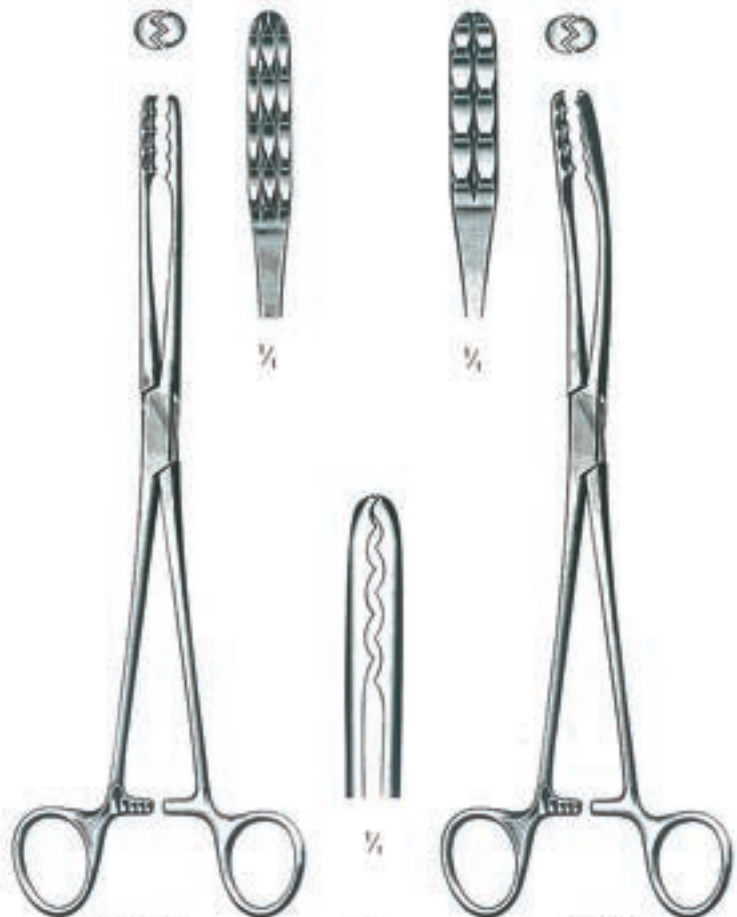

ULRICH		cm	ULRICH	
16.160.22	22		16.161.22	
16.160.25	25		16.161.25	

Schwammzangen
Sponge Holding Forceps
Pincès porte-éponges
Pinzas porta esponjas
Pinze per tamponi e spugne

16

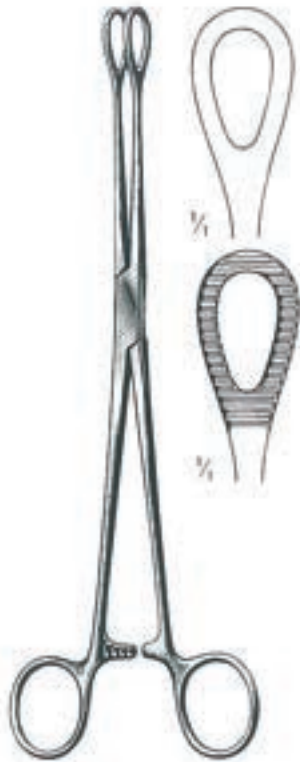

FOERSTER

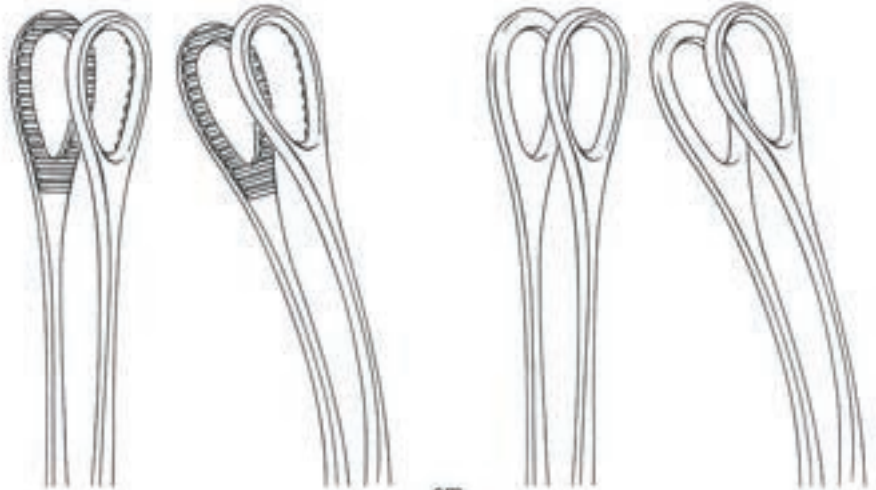

		cm		
16.170.18	16.171.18	18	16.172.18	16.173.18
16.170.20	16.171.20	20		
16.170.25	16.171.25	25	16.172.25	16.173.25

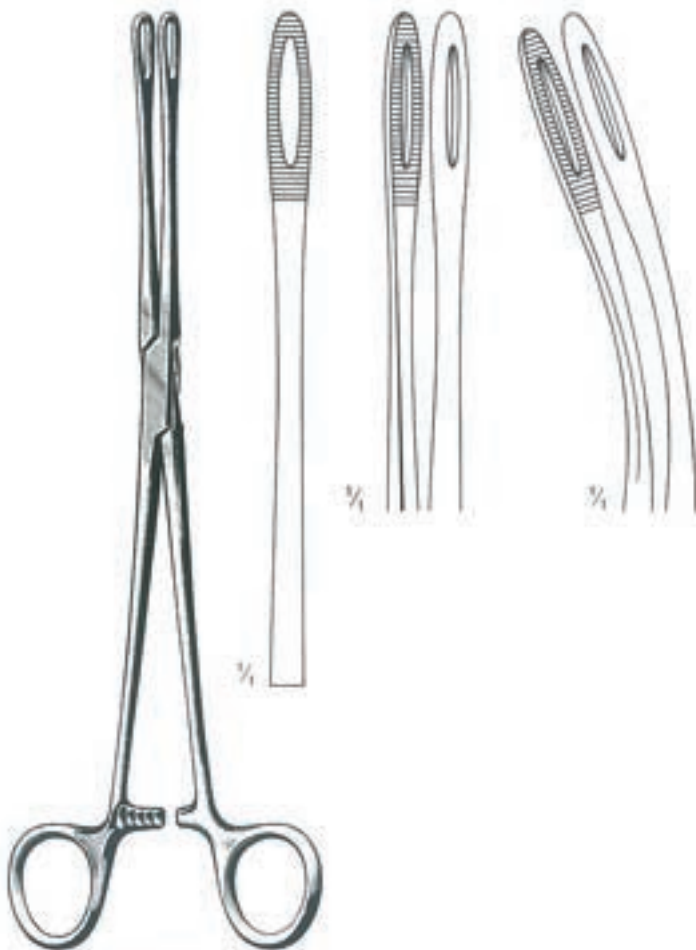

FOERSTER

16.174.25 25 cm 16.175.25 25 cm



RAMPLEY
16.180.25
25 cm

16

Schwammzangen
Dressing Forceps
Pincès à polypes
Pinzas para tapones
Pinze per tamponi



BRYANT
16.207.13
13 cm



cm	LISTER (Sinus)
13	16.210.13
16	16.210.16
18	16.210.18

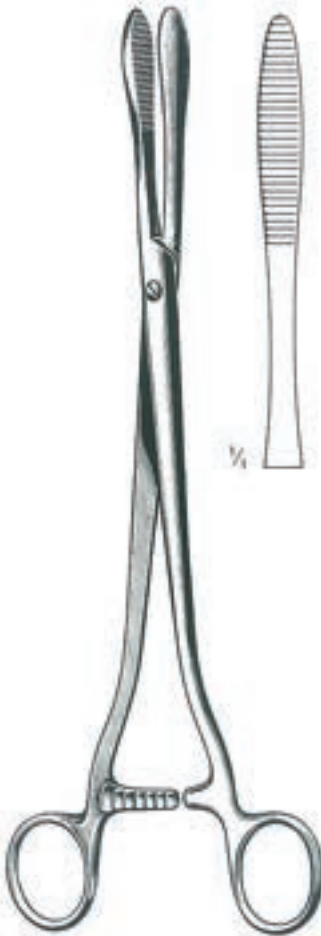

COLLIN
16.220.25
25 cm



PELKMAN
16.226.25
25 cm



CHERON
16.229.25
25 cm

Schwammzangen
Dressing Forceps
Pincès à polypes
Pinzas para tapones
Pinze per tamponi

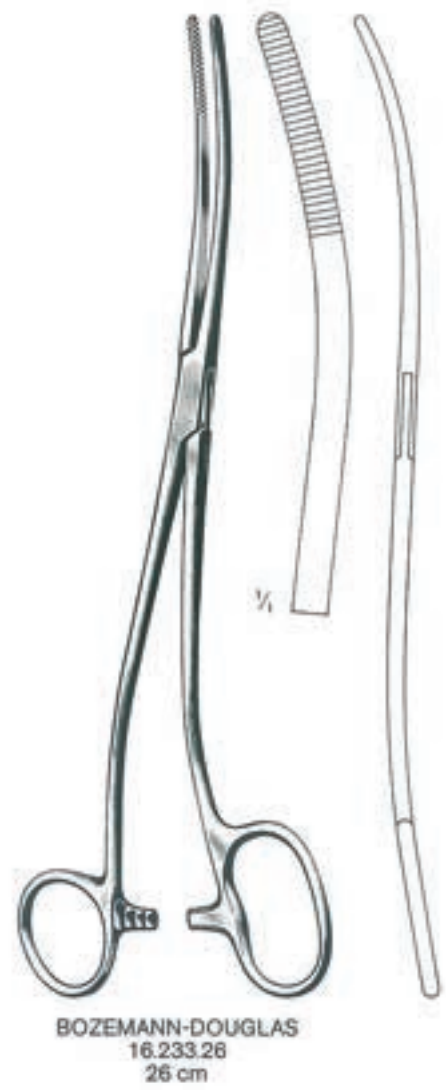
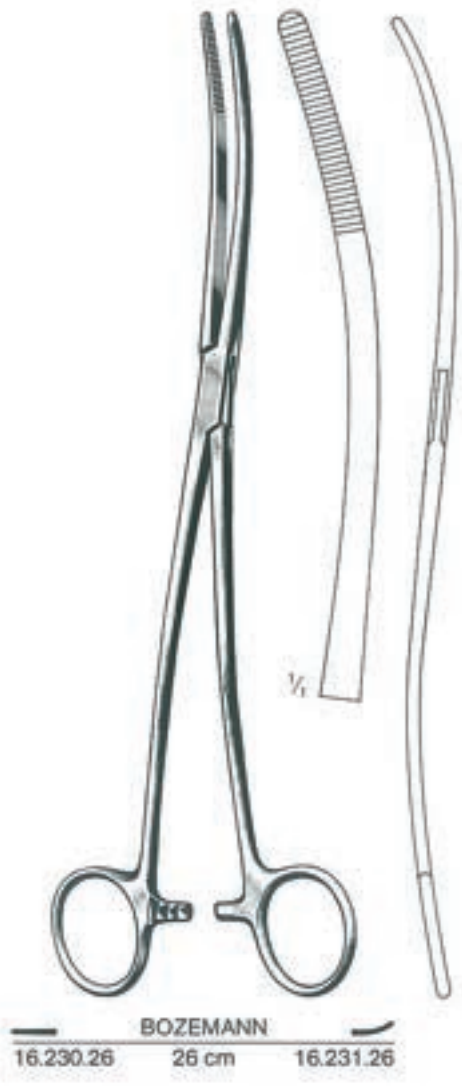

Wundhaken
Retractors
Ecarteurs
Separadores
Divaricatori

18



FARABEUFF
18.102.12
12 cm



FARABEUFF
18.102.15
15 cm



PARKER
18.110.13
13,5 cm



PARKER
18.110.18
18 cm



ROUX
18.120.00

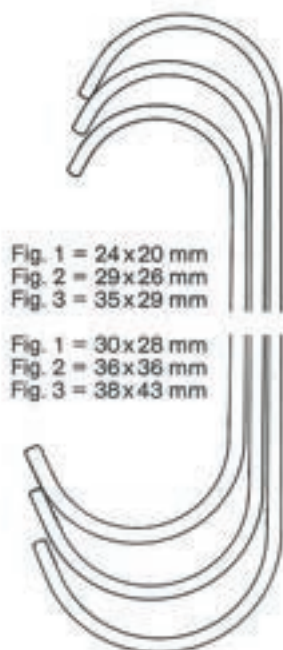

Fig. 1 = 24x20 mm
Fig. 2 = 29x26 mm
Fig. 3 = 35x29 mm

Fig. 1 = 30x28 mm
Fig. 2 = 36x36 mm
Fig. 3 = 38x43 mm

	Fig.	cm
18.120.14	1	14
18.120.15	2	15
18.120.17	3	17



ROUX Baby
18.122.13
13 cm



ROUX mini
18.124.15
15 cm



CRILE
18.127.11
11,5 cm

Wundhaken
Retractors
Ecarteurs
Separadores
Divaricatori



Wundhaken
Retractors
Ecarteurs
Separadores
Divaricatori

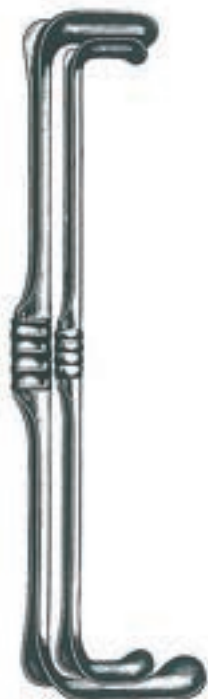

RICHARDSON-EASTMAN
18.140.00



18.150.01
28x20 mm



18.150.02
36x28 mm



18.150.03
44x38 mm



RICHARDSON



RICHARDSON Grip
18.152.25 20x25mm
18.152.31 25x31 mm
18.152.38 38x38mm
18.152.51 19x51 mm (Append.)
18.152.64 41x64 mm



65 x 50 mm

KELLY
18.158.26
26 cm



KELLY Grip
18.158.51 38x51 mm
18.158.64 51x64 mm
18.158.78 64x78 mm
18.158.82 70x82 mm

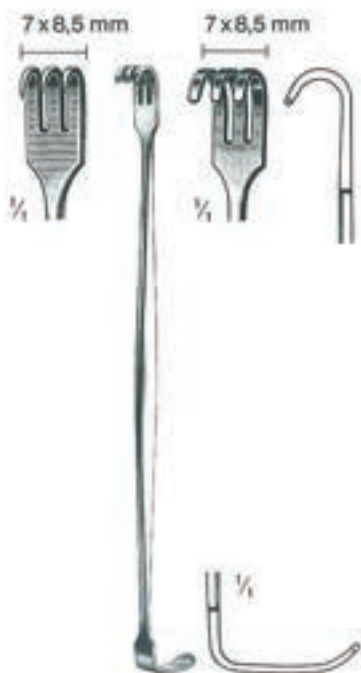

SENN
18.160.17 17 cm 18.161.17



RIBBON
18.168.12 12x200mm
18.168.17 17x200mm
18.168.25 25x250mm



RIBBON
18.170.25 25x330
18.170.32 32x330
18.170.40 40x330
18.170.60 50x330



HABERER
18.174.17 17/25x200 mm
18.174.25 25/30x250 mm
18.174.37 37/45x300 mm



REVERDIN
18.175.28
28 cm

Wundhaken
Retractors
Ecarteurs
Separadores
Divaricatori

18



DEAVER Grip

18.189.25	25 x 310 mm
18.189.38	38 x 310 mm
18.189.50	50 x 310 mm



HARRINGTON

18.191.25	25 x 230 mm
18.191.40	40 x 320 mm
18.191.62	62 x 320 mm

18

Wundhaken
Retractors
Ecarteurs
Separadores
Divaricatori

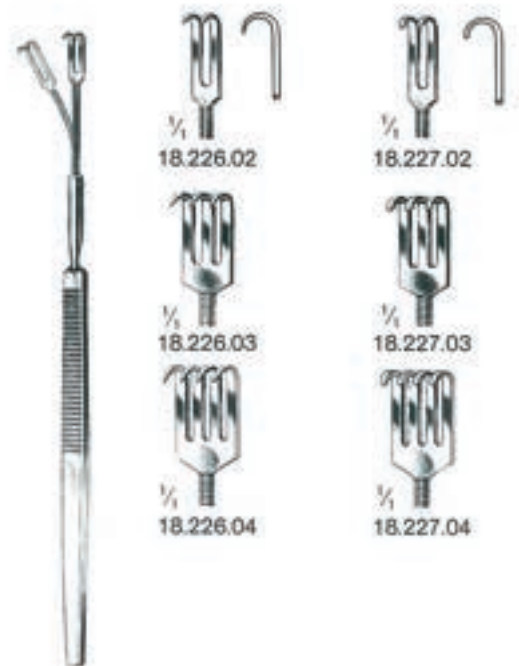
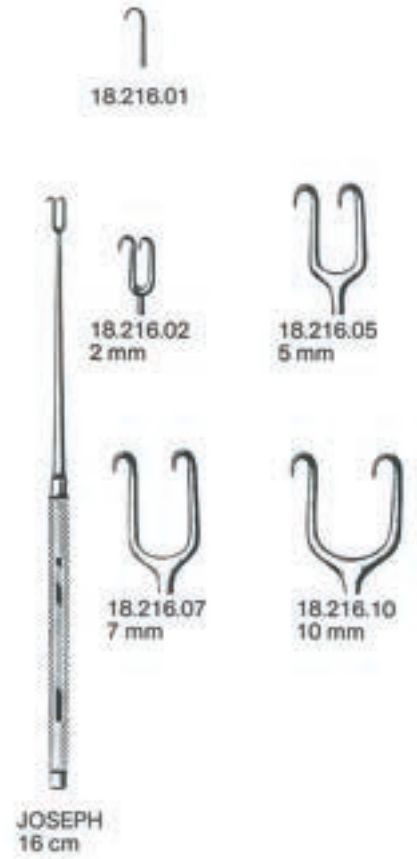

Wundhaken
Retractors
Ecarteurs
Separadores
Divaricatori



DESMARRES
16 cm

CUSHING
20 cm



18.230.12
12 mm

18.230.14
14 mm

18.230.16
16 mm

18.230.18
18 mm

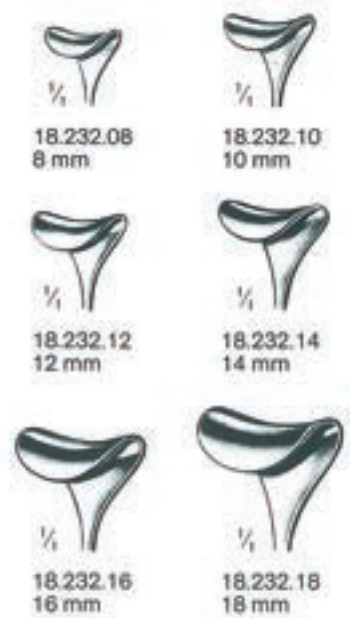

18.232.08
8 mm

18.232.10
10 mm

18.232.12
12 mm

18.232.14
14 mm

18.232.16
16 mm

18.232.18
18 mm



CUSHING
18.234.20
20 cm

CUSHING
18.234.21
21,5 cm



SENN-GREEN
18.240.10 10x6 mm
18.240.20 20x6 mm

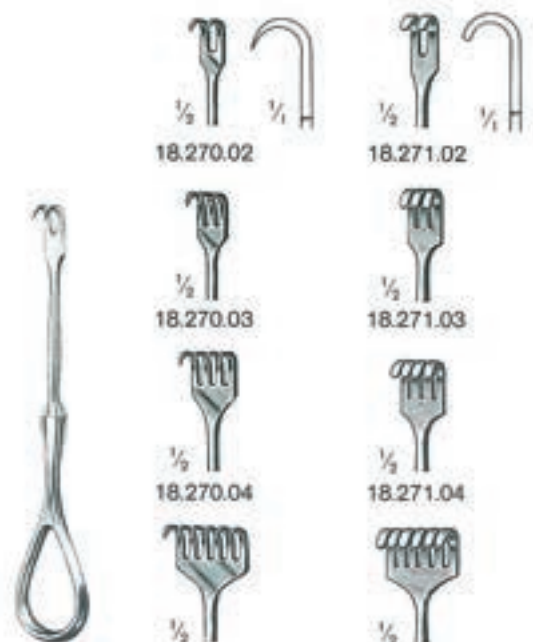

18.270.02

18.271.02

18.270.03

18.271.03

18.270.04

18.271.04

18.270.06

18.271.06

VOLKMANN
11.5 cm

18

Wundhaken
Retractors
Ecarteurs
Separadores
Divaricatori



VOLKMANN
21.5 cm



MEYERDING
18 cm



LAHEY
18.304.19
19 cm



LITTLE
18.306.20
20 cm

Wundhaken
Retractors
Ecarteurs
Separadores
Divaricatori



18.310.01
- 18.310.05
22 cm

18.312.01
- 18.312.05
21 cm

LANGENBECK

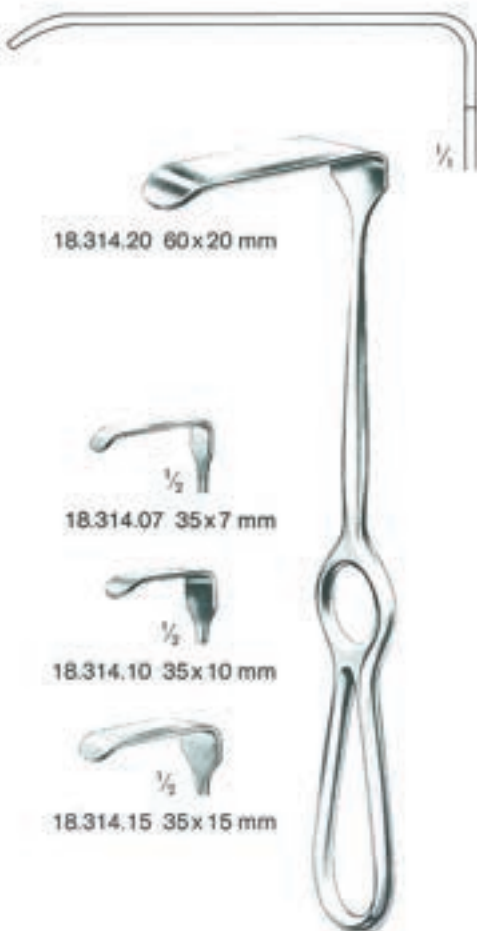
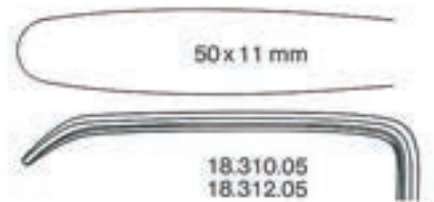
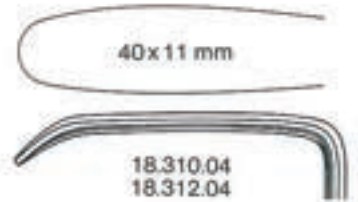
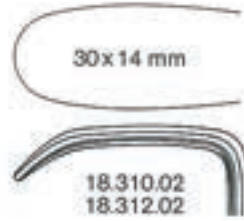
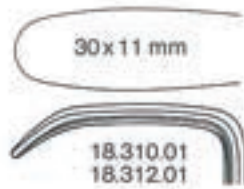

18.314.20 60x20 mm

18.314.07 35x7 mm

18.314.10 35x10 mm

18.314.15 35x15 mm

LANGENBECK
18.314.07 - 18.314.20
21 cm



60x20 mm

LANGENBECK
18.315.21
21 cm



85x15 mm

LANGENBECK
18.317.21
21 cm

Wundhaken
Retractors
Ecarteurs
Separadores
Divaricatori

18

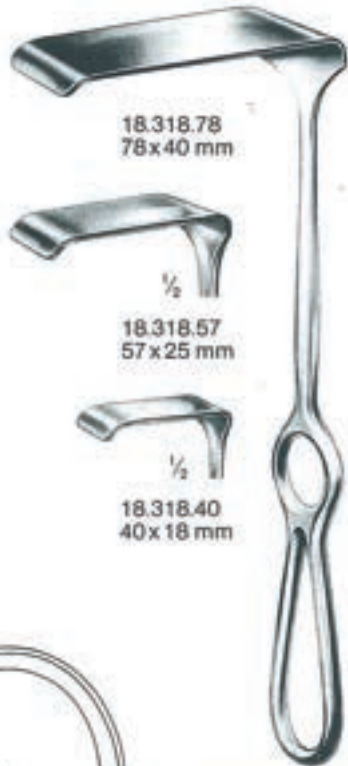

18.318.78
78x40 mm



18.318.57
57x25 mm



18.318.40
40x18 mm

18.318.40-18.318.78
23 cm



18.330.40
40x12 mm



18.330.55
55x11 mm

KOCHER
18.330.40-18.330.55
19 cm

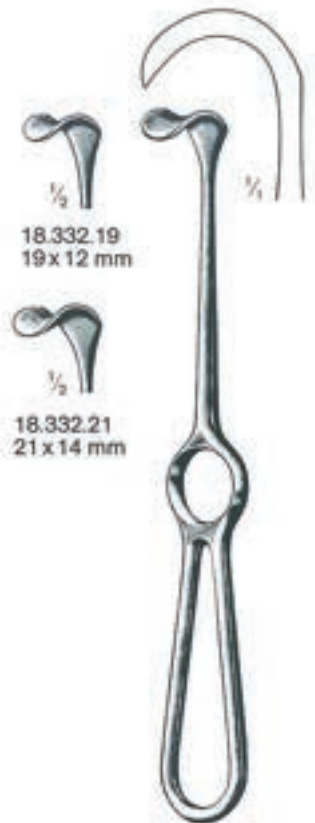

18.332.19
19x12 mm

18.332.21
21x14 mm

KOCHER
18.332.19-18.332.21
19 cm



KOCHER	mm
18.340.10	40x10
18.340.15	40x15
18.340.20	40x20
22 cm	

18.344.14
14x17 mm
21,5 cm

18.344.20
20x22 mm
22 cm

18.344.26
26x30 mm
23,5 cm



MIDDELDORPF
18.344.14-18.344.26



GREEN
18.348.22
22 cm



OLLIER
18.360.04
22,5 cm

Wundhaken
Retractors
Ecarteurs
Separadores
Divaricatori

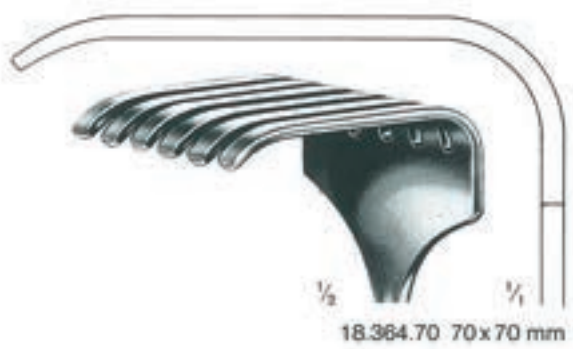
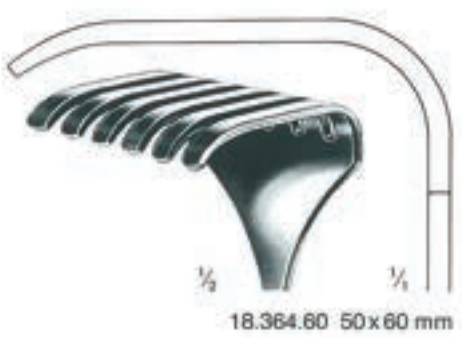
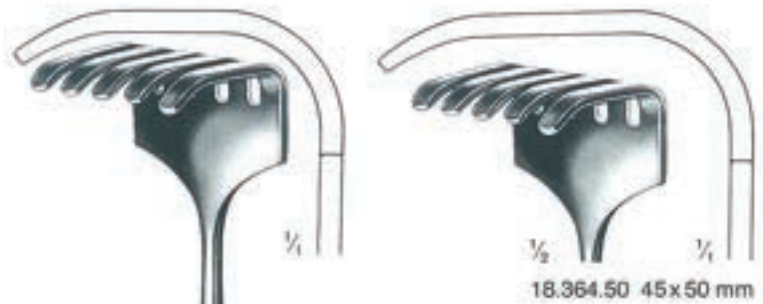

KOERTE
18.366.08 23,5 cm 18.367.08

FRITSCH mm
18.370.40 45x40
18.370.50 45x50
18.370.60 45x60
18.370.75 45x75
24 cm

KOCHER
18.372.22
22,5 cm

KOCHER mm
18.374.45 80x45
18.374.55 80x55
18.374.65 80x65
25 cm

18

Wundhaken
Retractors
Ecarteurs
Separadores
Divaricatori



50 x 85 mm

DOYEN
18.378.25
25 cm

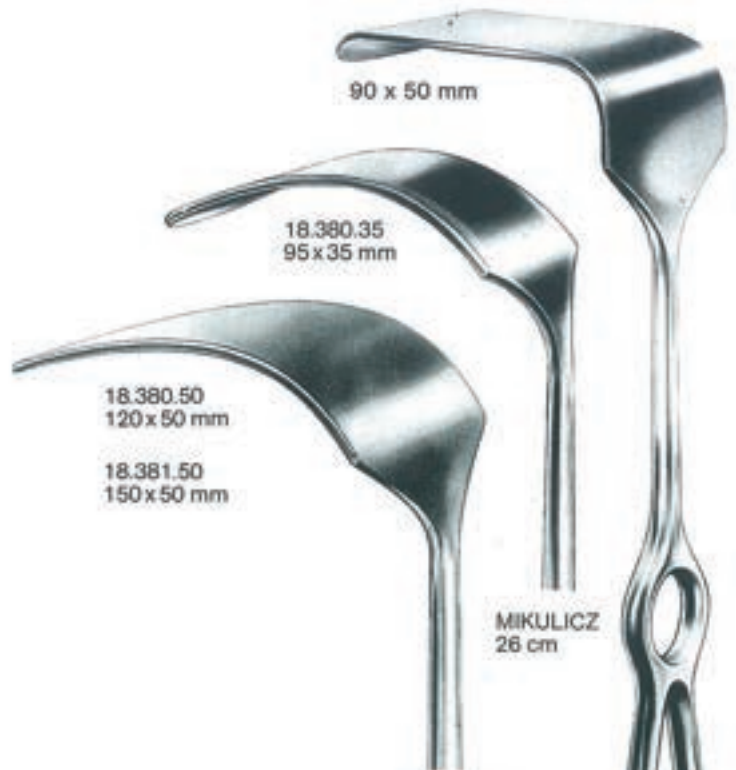

90 x 50 mm

18.380.35
95 x 35 mm

18.380.50
120 x 50 mm

18.381.50
150 x 50 mm

MIKULICZ
26 cm

MIKULICZ
26 cm



18.482.82
82 x 28 mm

18.482.73
73 x 28 mm

MIKULICZ
18.382.50
26 cm

1/2

18.482.45
45 x 25 mm

1/2

mm	KELLY
160x38	18.385.38
160x57	18.385.57
	27 cm

SIMON	mm
18.480.22	115x22
18.480.27	115x27
	28 cm

HEANEY
18.482.45-18.482.82
27 cm

Wundhaken
Retractors
Ecarteurs
Separadores
Divaricatori

18.490.65
115x65 mm

18.490.43
108x43 mm

18.490.22
82x22 mm

125x37 mm

18.494.45
45x15 mm

18.494.60
60x23 mm

18.494.75
75x20 mm

CORYLLOS (Thorax)
18.490.22-18.490.65
24 cm

SAUERBRUCH
18.492.25
25 cm

SAUERBRUCH
18.494.45-18.494.75
22.5 cm



DAVIDSON (Scapula)
18.496.50
75x50 mm



DAVIDSON (Scapula)
18.496.90
75x90 mm

18

Wundsperrer
Retractors
Ecarteurs
Separadores
Divaricatori

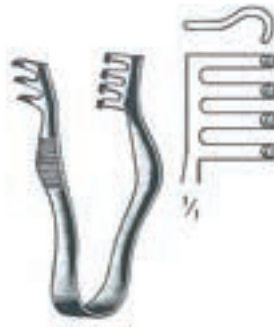

FINSEN
18.610.07 7 cm 18.611.07

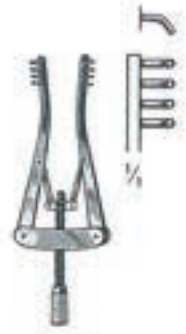

ALM
18.620.07 7 cm 18.621.07
18.620.10 10 cm 18.621.10



JANSEN
18.630.10
10 cm



JANSEN
18.631.10
10 cm



DIMEDA
18.634.10 10cm 18.635.10

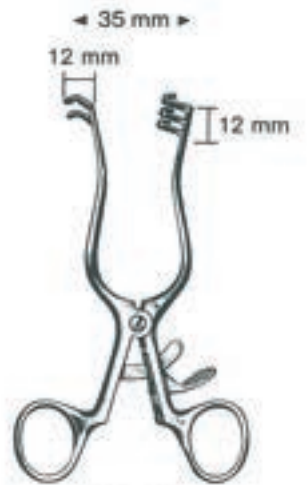

WEITLANER
18.650.10 11,5cm 18.651.10

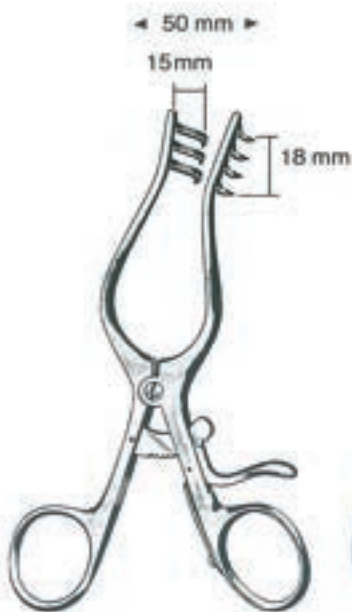

WEITLANER-WULLSTEIN
18.654.13 13 cm 18.655.13



PLESTER
18.657.11
11 cm



PLESTER
18.659.11
11 cm

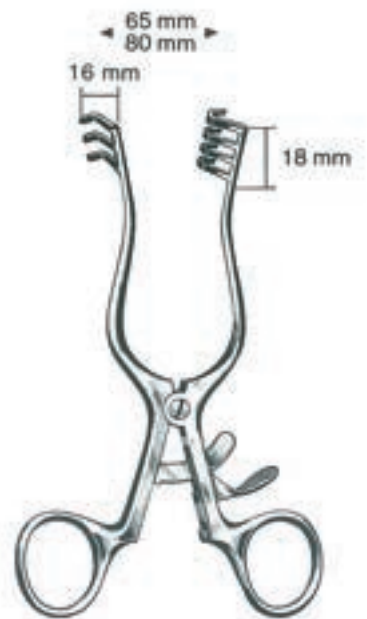

WEITLANER
18.670.14 14,0 cm 18.671.14
18.670.16 16,5 cm 18.671.16
18.670.20 20,0 cm 18.671.20

Wundsperrer
Retractors
Ecarteurs
Separadores
Divaricatori

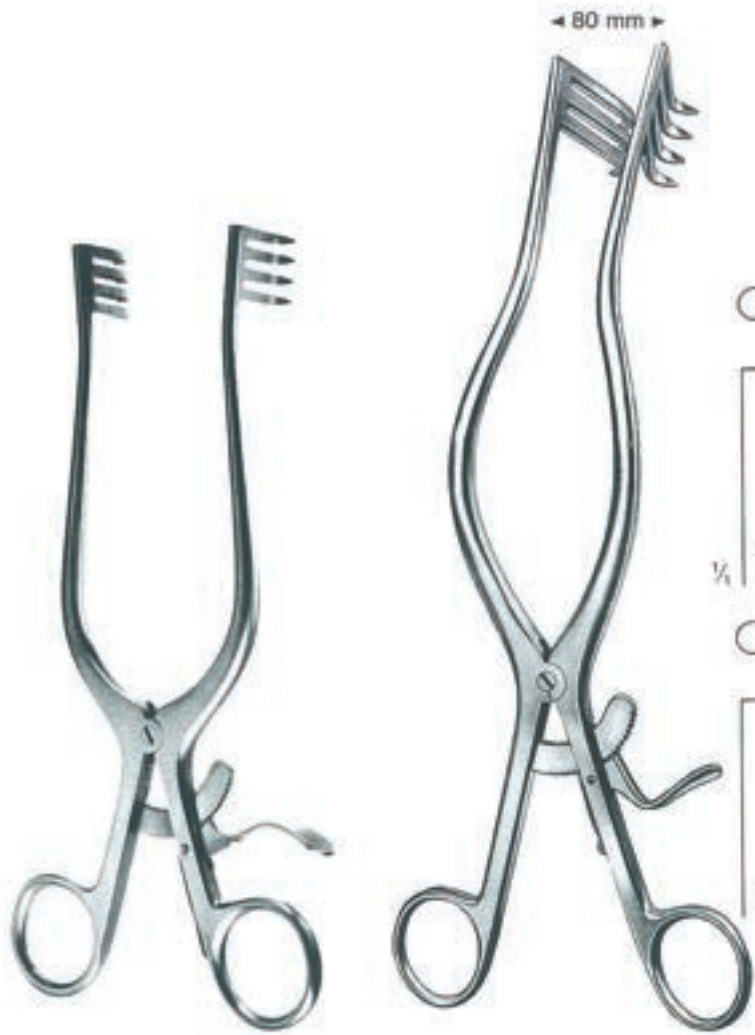

ADSON
18.680.19 19 cm 18.681.19

ADSON
18.682.26-18.683.26
26,5 cm

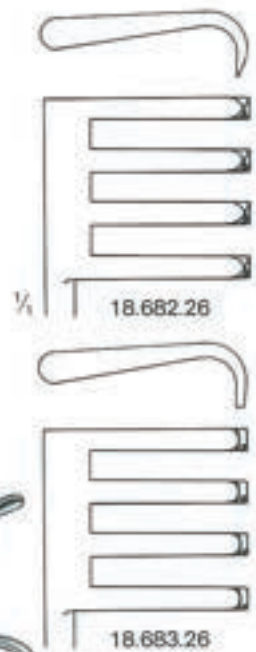

BECKMANN-ADSON
18.686.32
32 cm

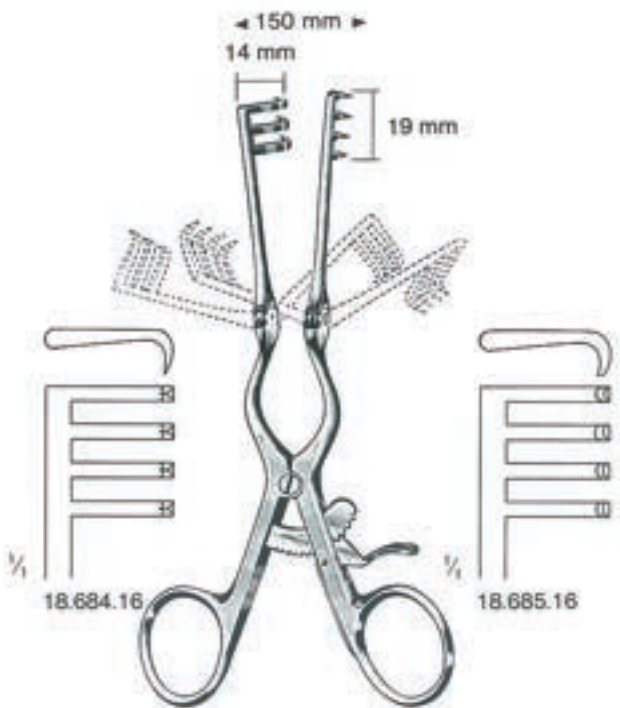

ADSON Baby
18.684.16-18.685.16
16 cm

Wundsperrer
Retractors
Ecarteurs
Separadores
Divaricatori



BECKMANN
18.690.31
31 cm



BECKMANN-EATON
18.692.32
32 cm

Wundsperrer
Retractors
Ecarteurs
Separadores
Divaricatori



MOLLISON
18.693.15
15 cm



DARLING
18.696.18
18 cm

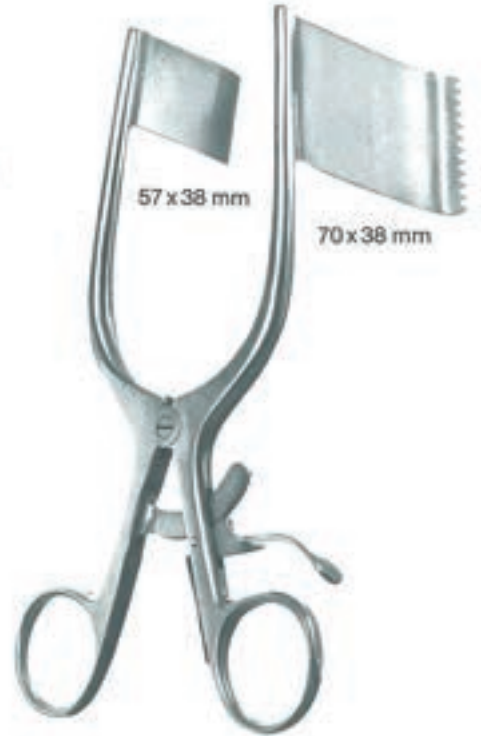

DARLING
18.698.18
18 cm



CLOWARD
18.710.00
18.710.01

ohne Valven · without blades
sans valves · sin valvas · senza valve

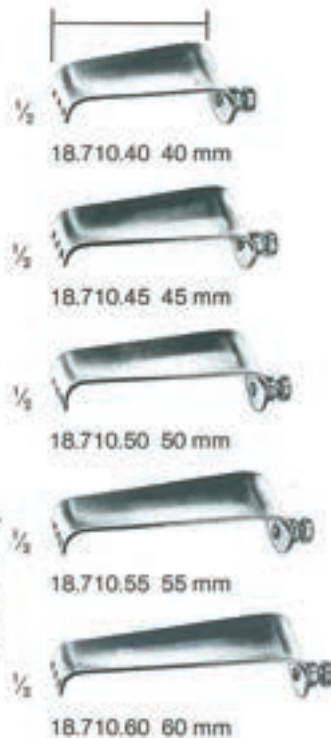

CLOWARD
18.711.00
18.711.01

ohne Valven · without blades
sans valves · sin valvas · senza valve



18

Wundspreizer, cerv. Wirbelsäule
Retractors, Cervical Spine
Ecarteurs, colonne cervicale
Separadores, columna espinal
Divaricatori, spina cervica



CASPAR
18.724.00 compl.
18.724.11



CASPAR
18.720.00 compl.
18.720.15 ohne Valven · without blades
sans valves · sin valvas · senza valve



stumpf
blunt
mousse
roma
smussa

mm	CASPAR
45 x 20	18.720.45
50 x 20	18.720.50
55 x 20	18.720.55
60 x 20	18.720.60
65 x 20	18.720.65



medial

mm	CASPAR
40 x 20	18.724.40
45 x 20	18.724.45
50 x 20	18.724.50
55 x 20	18.724.55
60 x 20	18.724.60



CASPAR
18.721.00 compl.
18.721.15 ohne Valven · without blades · sans valves · sin valvas · senza valve



lateral

mm	CASPAR
40 x 20	18.725.40
45 x 20	18.725.45
50 x 20	18.725.50
55 x 20	18.725.55
60 x 20	18.725.60

Wundsperrer, ges. Wirbelsäule
 Retractors, vertebral Column
 Ecarteurs, colonne vertébrale
 Separadores, columna vertebral
 Divaricatori, colonna vertebrale



CASPAR
 18.730.00 compl.
 18.730.15 ohne Valven · without blades · sans valves · sin valvas · senza valve



mm	CASPAR
50	18.731.50



mm	CASPAR
70	18.731.70



mm	CASPAR
35x22	18.732.35
40x22	18.732.40
45x22	18.732.45
50x22	18.732.50
55x22	18.732.55
60x22	18.732.60
65x22	18.732.65
70x22	18.732.70



mm	CASPAR
35x37	18.733.35
40x37	18.733.40
45x37	18.733.45
50x37	18.733.50
55x37	18.733.55
60x37	18.733.60
65x37	18.733.65
70x37	18.733.70



mm	CASPAR
35x52	18.734.35
40x52	18.734.40
45x52	18.734.45
50x52	18.734.50
55x52	18.734.55
60x52	18.734.60
65x52	18.734.65
70x52	18.734.70



CASPAR
 18.740.00 compl.
 18.740.15 ohne Valven · without blades · sans valves · sin valvas · senza valve

Wundspreizer
Retractors
Ecarteurs
Separadores
Divaricatori

18.745.40
40 mm



18.745.45
45 mm



18.745.50
50 mm



18.745.55
55 mm



18.745.60
60 mm



18.745.65
65 mm



18.745.70
70 mm



CASPAR
18.744.00 compl incl. 5 Valven · blades
valves · valvas · valve
18.744.17 ohne Valven · without blades · sans valves · sin valvas · senza valve



18.747.45
45 mm

18.747.50
50 mm

18.747.55
55 mm

18.747.60
60 mm

18.747.65
65 mm



CASPAR
18.747.45-18.747.65

Bauchdeckenhalter
Abdominal Retractors
Ecarteurs abdominaux
Separadores abdominales
Divaricatori addominali

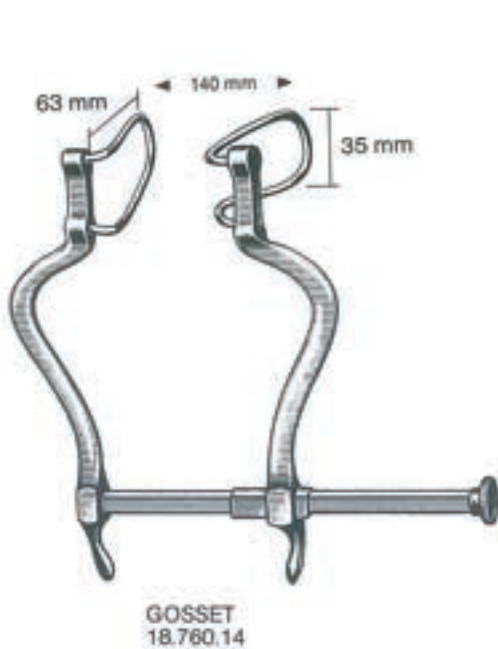
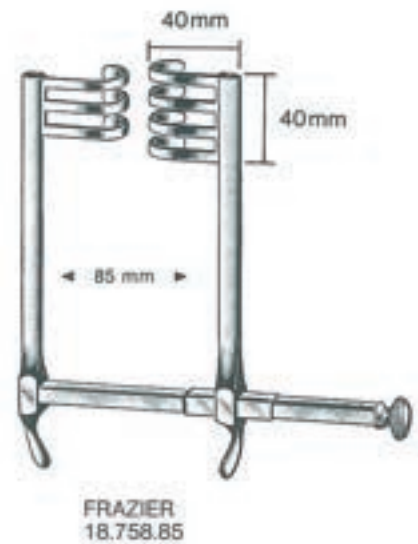
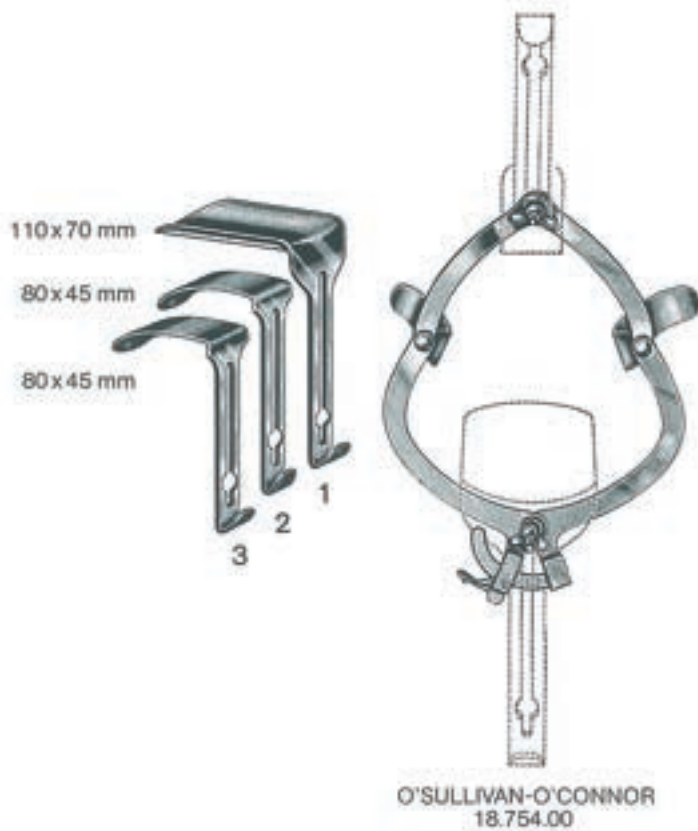

Bauchdeckenhalter
Abdominal Retractors
Ecarteurs abdominaux
Separadores abdominales
Divaricatori addominali

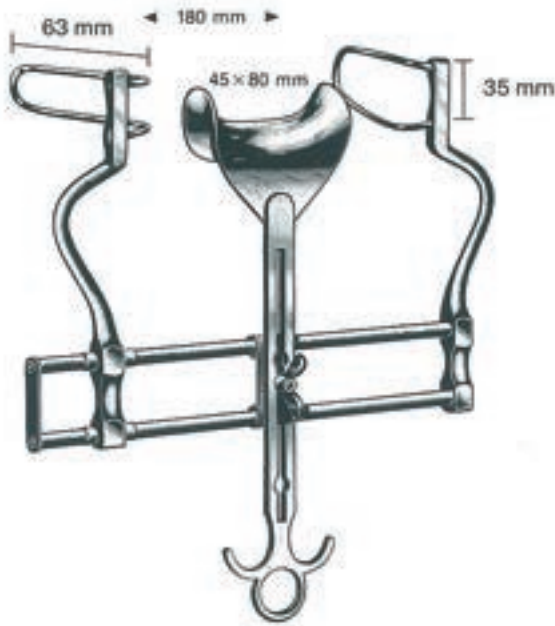

BALFOUR
18.764.18
18 cm

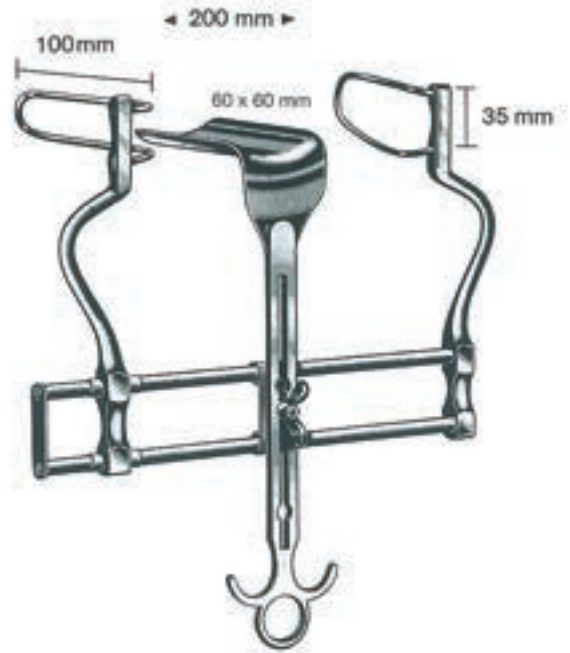

BALFOUR
18.764.20
20 cm

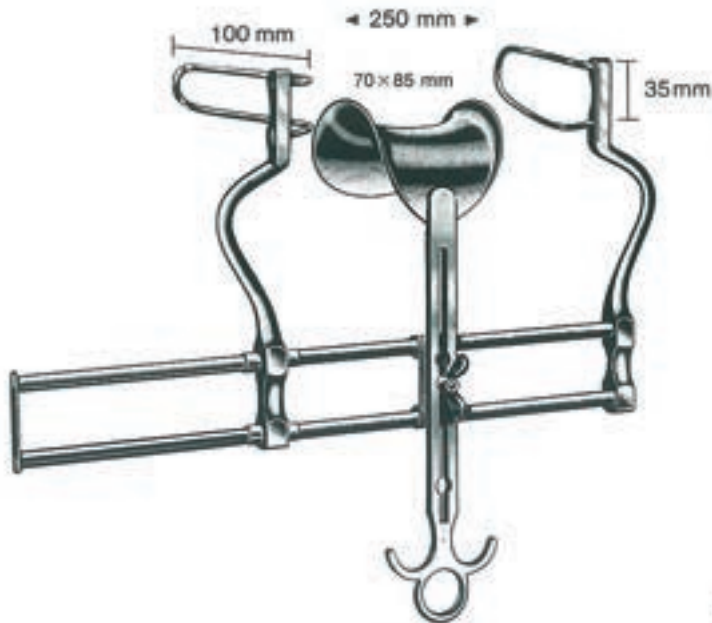

BALFOUR
18.764.25
25 cm



mm	BALFOUR
45 x 80	18.765.45
70 x 85	18.765.70
80 x 90	18.765.80

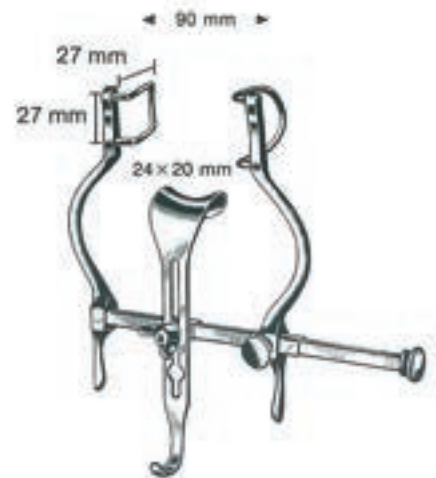

BALFOUR Baby
18.766.90
9 cm

Bauchdeckenhalter
Abdominal Retractors
Ecarteurs abdominaux
Separadores abdominales
Divaricatori addominali

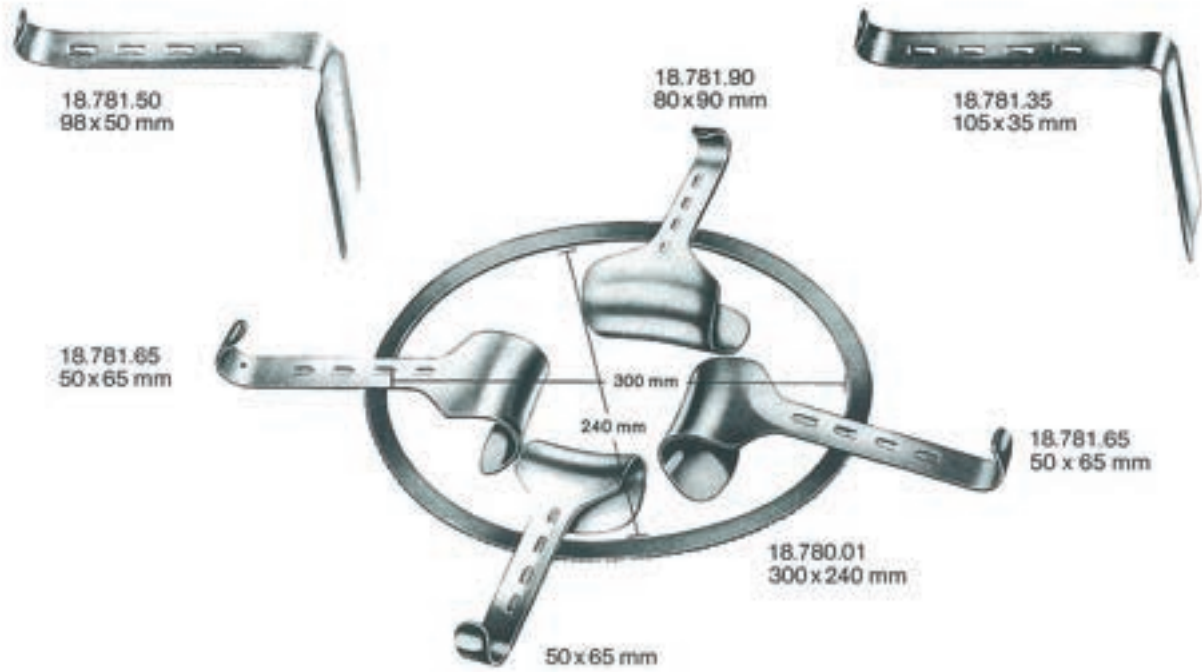

18.781.50
98 x 50 mm

18.781.90
80 x 90 mm

18.781.35
105 x 35 mm

18.781.65
50 x 65 mm

18.781.65
50 x 65 mm

18.780.01
300 x 240 mm

50 x 65 mm

KIRSCHNER

18.780.00 compl.

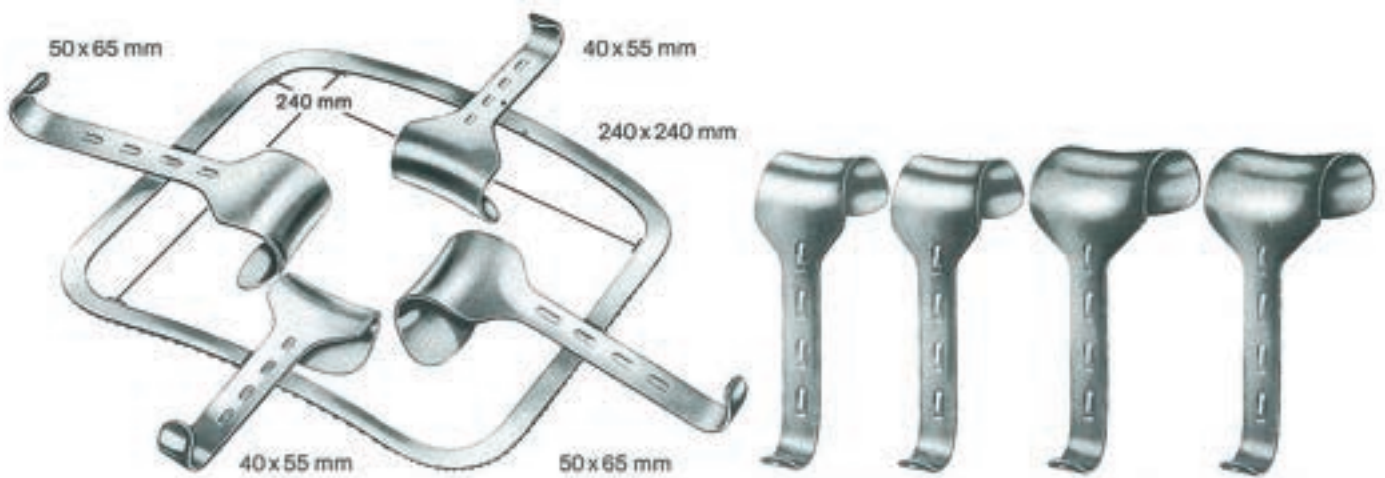

50 x 65 mm

40 x 55 mm

240 mm

240 x 240 mm

40 x 55 mm

50 x 65 mm

18.781.55
40 x 55 mm

18.781.65
50 x 65 mm

KIRSCHNER

18.782.00 compl.

18

Bauchdeckenhalter
Abdominal Retractors
Ecarteurs abdominaux
Separadores abdominales
Divaricatori addominali



cm	GELPI
9	18.802.09
14	18.802.14
16	18.802.16
18	18.802.18



GELPI
18.804.18
18 cm

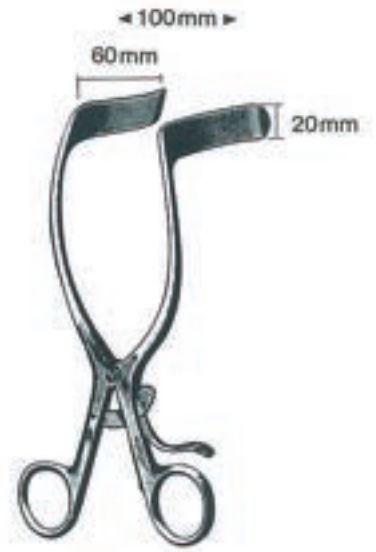

RIGBY
18.806.18
18 cm

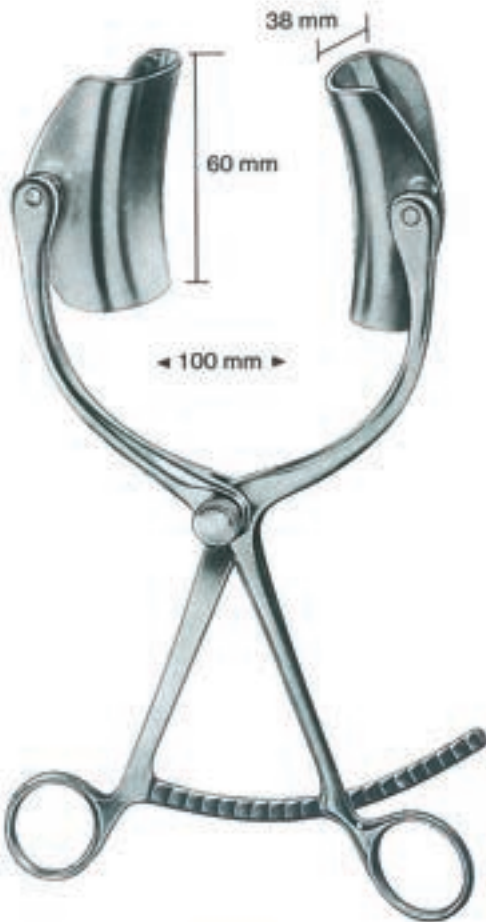

COLLIN
18.810.22



Central/mm	COLLIN
38 x 55	18.812.60
50 x 75	18.812.80

Bauchdeckenhalter
Abdominal Retractors
Ecarteurs abdominaux
Separadores abdominales
Divaricatori addominali

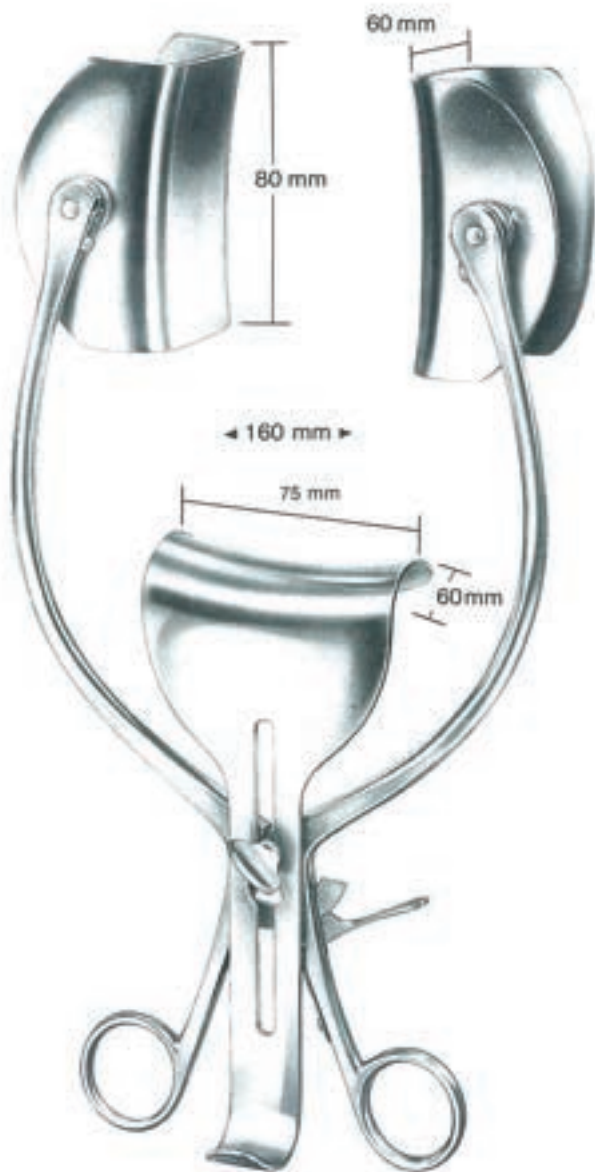

COLLIN Loktite
18.816.00

Muskelhaken
Muscle Retractors (Hooks)
Ecarteurs musculaires
Separadores (ganchos) musculares
Divaricatori (uncini) muscolari



18.902.10
10 cm



18.903.00

20

Sonden
Probes, Directors
Stylets, sondes
Sondas, estiletes
Sonde, specilli



cm	2 mm Ø	1 mm Ø	2 mm Ø	DOYEN		STACKE
10,5				20.108.10		20.115.10
11,5	20.102.11	20.104.11	20.106.11	20.108.13	20.110.11	
13,0	20.102.13	20.104.13	20.106.13	20.108.13	20.110.13	20.112.13
14,0					20.111.14	
14,5	20.102.14	20.104.14	20.106.14	20.108.14	20.110.14	20.112.14
16,0	20.102.16	20.104.16	20.106.16		20.110.16	20.112.16
18,0	20.102.18	20.104.18	20.106.18		20.110.18	20.112.18
20,0	20.102.20	20.104.20	20.106.20	20.108.20	20.110.20	
25,0	20.102.25	20.104.25	20.106.25			

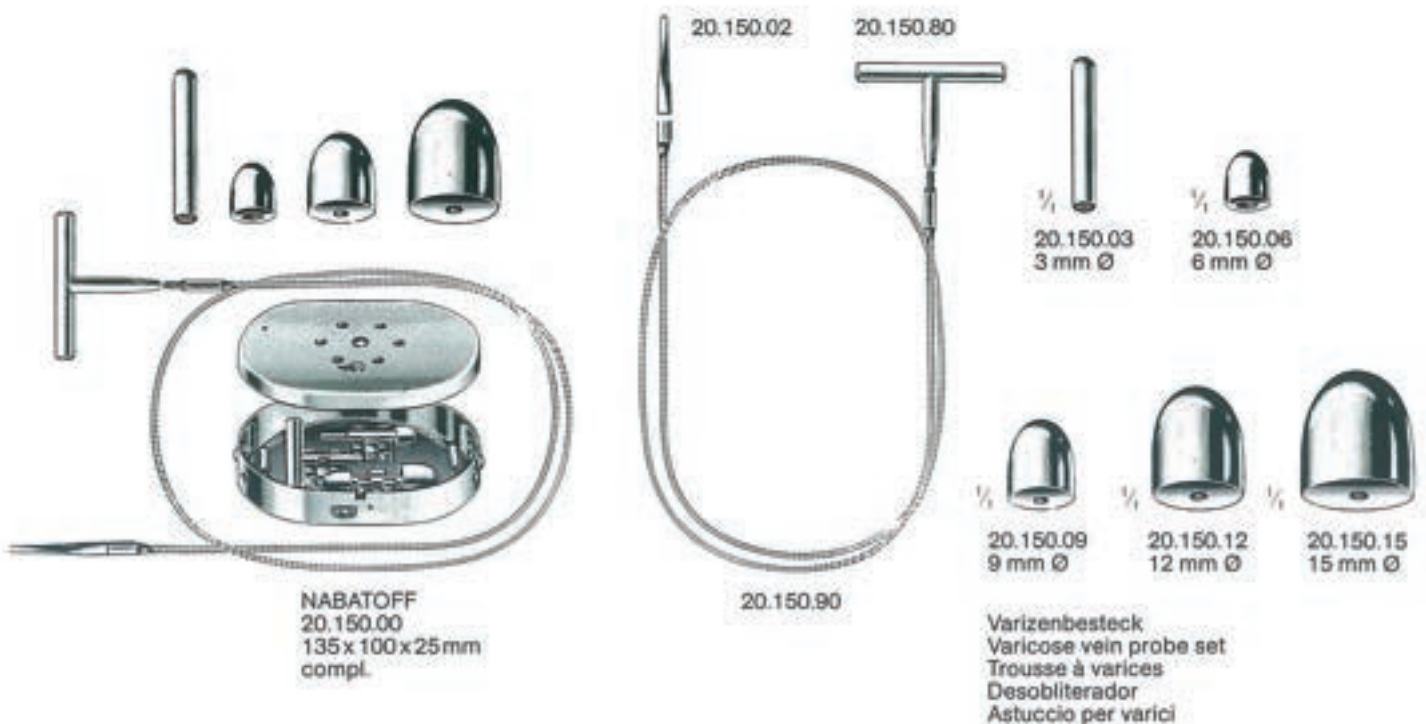

Spatel, Watteträger
Spatulas, Cotton Applicators
Spatules, porte-coton
Espátulas, porta-algodón
Spatole, portacotone

20

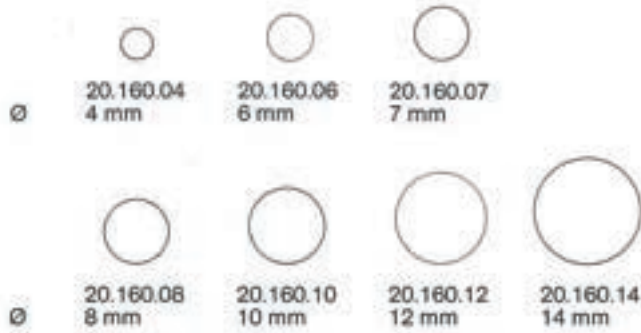

20.160.04 - 20.160.14



20.162.12
12 cm

Pflasterspatel
Plaster spatula
Spatules
Espátulas
Spatole



cm	
13,0	20.190.13
14,5	20.190.14

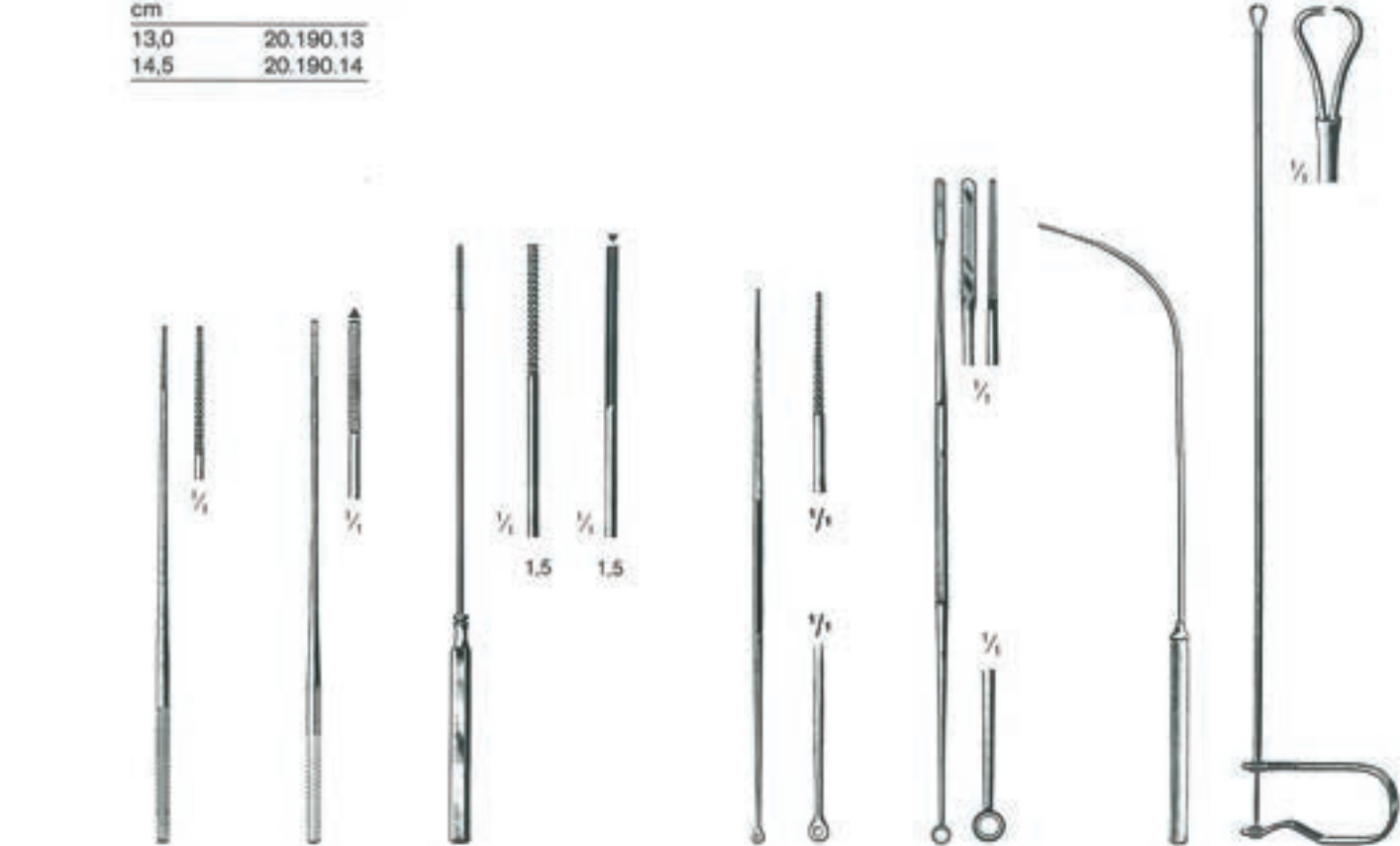

cm	FARRELL	FARRELL	DIMEDA	UCKERMANN	JOBSON-HORNE	TOBOLD
12,0	20.270.12	20.272.12	20.290.12	20.292.12	20.320.12	
14,0	20.270.14	20.272.14	20.290.14	20.292.14		
15,0				20.310.15		
16,0			20.290.16	20.292.16		
16,5	20.270.16	20.272.16				
18,0	20.270.18	20.272.18	20.290.18	20.292.18	20.320.18	
23,0	20.270.23	20.272.23				
25,0						20.331.25
45,0						20.340.45

22

Trokare
Trocars
Trocart
Trócares
Trequarti

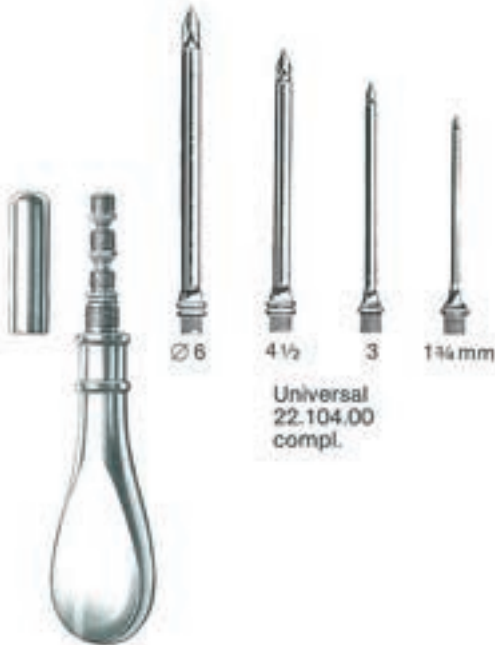

Universal
22.104.00
compl.

mm	Standard	Standard	PIERCE
3,0	22.110.30	22.120.30	22.123.30
3,5	22.110.35	22.120.35	
4,0	22.110.40	22.120.40	22.123.40
4,5	22.110.45	22.120.45	
5,0	22.110.50	22.120.50	22.123.50
5,5	22.110.55	22.120.55	
6,0	22.110.60	22.120.60	



DOUGLAS
22.125.11
3 mm Ø

FLEURANT
22.127.23
23 cm
5 mm Ø



LICHTWITZ
22.128.19
1,75 mm Ø

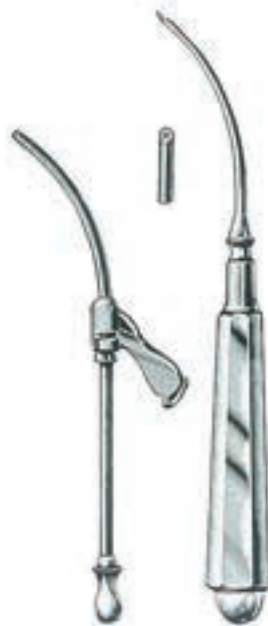

COAKLEY
22.140.02
2,25 mm Ø

Charr./ F.G.	OCHSNER
10	22.150.10
12	22.150.12
14	22.150.14
16	22.150.16
18	22.150.18
20	22.150.20



Charr./ F.G.	NELSON
25	22.170.25
30	22.170.30
33	22.170.33
35	22.170.35

Biopsie, Leber, Niere
Biopsy, Liver, Kidney
Biopsie, foie, reins
Biopsia, hígado, riñón
Biopsia, fegato, rene

Pneumoperitoneum
Pneumopéritoine
Neumoperitoneo
Pneumoperitoneo



	VERRES	mm	QUINKE
22.210.00 compl.	22.250.20	1,2x76	22.230.12
	2,0x100 mm	1,2x89	22.232.12
Pudendus Anesthesia		1,0x76	22.230.10
anesthesia		1,0x89	22.232.10
		0,7x76	22.230.07
		0,7x89	22.232.07

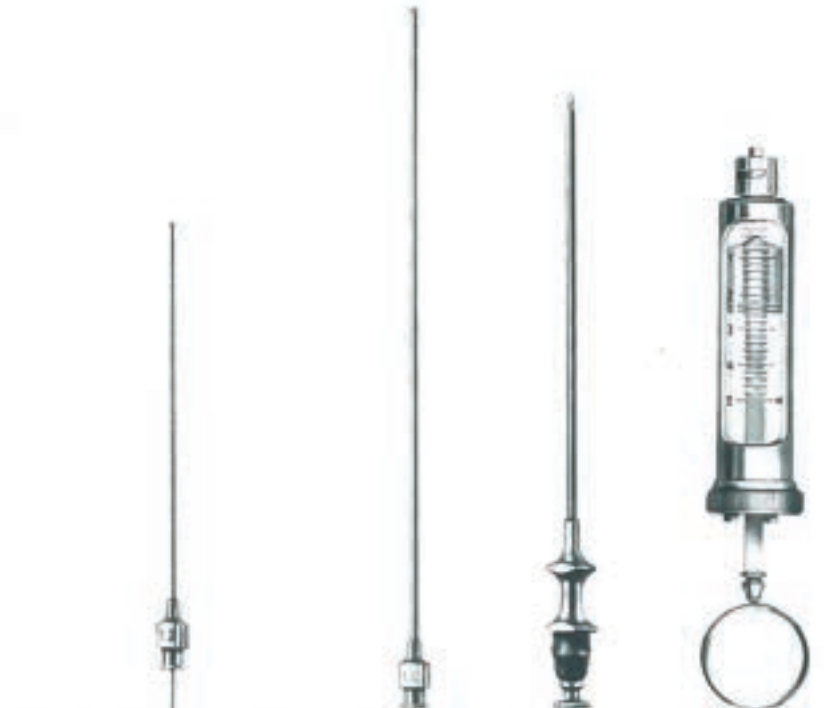

mm	MENGHINI	mm	MENGHINI	22.312.14	cc
1,0x35	22.302.01	1,4x168	22.310.14	22.312.18	5
1,0x70	22.302.02	1,8x168	22.310.18		10
1,2x70	22.302.03				22.314.05
1,2x100	22.302.04				22.314.10
1,4x70	22.302.05				
1,4x100	22.302.06				
1,6x70	22.302.07				
1,8x100	22.302.08				



Ø ext.xL mm	Ø int.xL mm	FRANKLIN-SILVERMANN
2,0x105	1,5x155	22.330.20
2,0x130	1,5x180	22.330.14
		compl.

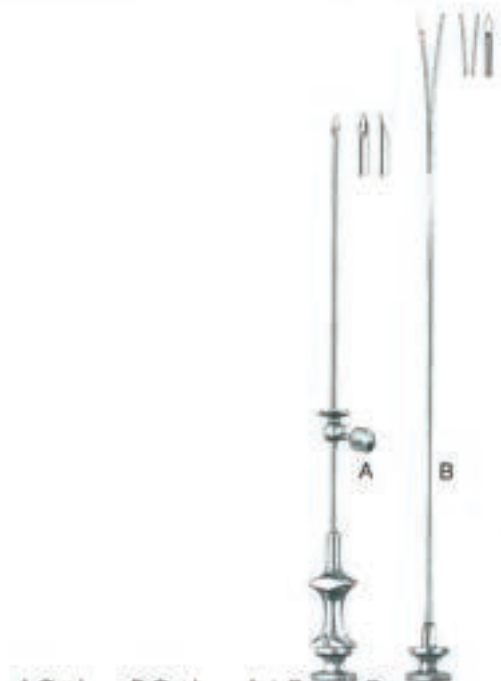

A Ø x L mm	B Ø x L mm	A + B FRANKLIN-SILVERMANN	B
2,0x100	1,5x150	22.350.20	22.352.15
2,5x145	2,0x195	22.350.30	22.352.20
2,0x100	1,5x150	22.354.20	22.356.15
2,5x145	2,0x195	22.354.25	22.356.20

Nadelhalter
Needle Holders
Porte-aiguilles
Porta-agujas
Port'aghi

Mit TC-Einsätzen
 TC Lined
 A mors TC
 Con bocas TC
 Con morso TC



DERF
 24.110.12 12 cm 24.114.12



DERF
 24.120.12 12,5 cm



COLLIER
 24.122.12 12,5 cm



HALSEY
 24.130.13 13 cm 24.140.13
 24.134.13 13 cm 24.144.13



NEIVERT
 24.146.13



BAUMGARTNER
 24.150.12 12,5 cm 24.154.12
 24.150.14 14,0 cm 24.154.14



CRILE-WOOD
 24.160.15 15 cm 24.164.15
 24.160.18 18 cm 24.164.18
 24.160.20 20 cm 24.164.20



CRILE-MURRAY
 24.170.15 15 cm 24.174.15



MAYO-HEGAR
 24.180.14 14 cm 24.184.14
 24.180.16 16 cm 24.184.16
 24.180.18 18 cm 24.184.18
 24.180.20 20 cm 24.184.20
 24.180.24 24 cm 24.184.24
 24.180.26 26 cm 24.184.26
 24.180.30 30 cm 24.184.30



MAYO-HEGAR
 24.190.16 16 cm 24.194.16
 24.190.18 18 cm 24.194.18
 24.190.20 20 cm 24.194.20

Nadelhalter
Needle Holders
Porte-aiguilles
Porta-agujas
Port'aghi



cm	DE BAKEY	RYDER
13		24.224.13
15	24.214.15	24.224.15
18	24.214.18	24.224.18
20	24.214.20	24.224.20
23	24.214.23	24.224.23
26	24.214.26	24.224.26
31	24.214.31	
37	24.214.37	



JAMISON
24.230.23 23,5cm 24.234.23



HEANEY
24.241.21 21cm 24.245.21



MASSON
24.250.27 27 cm 24.254.27



WANGENSTEEN
24.260.27 27 cm 24.264.27



WANGENSTEEN
24.270.27 27 cm 24.274.27



cm	BOZEMANN
20	24.285.20
24	24.285.24
26	24.285.26

Nadelhalter
Needle Holders
Porte-aiguilles
Porta-agujas
Port'aghi

Mit TC-Einsätzen
TC Lined
A mors TC
Con bocas TC
Con morso TC



METZENBAUM
24.290.18
18 cm



ADSON
24.292.18
18 cm

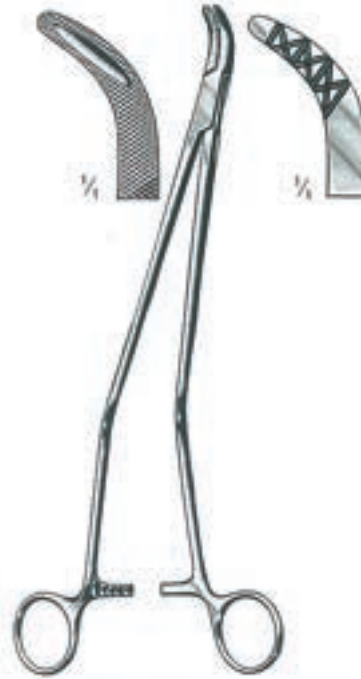

JOHNSON
24.293.27
27 cm



FINOCHIETTO
24.311.20 20 cm 24.315.20
24.311.27 27 cm 24.315.27



SAROT
24.320.18 18 cm 24.324.18
24.320.26 26 cm 24.324.26

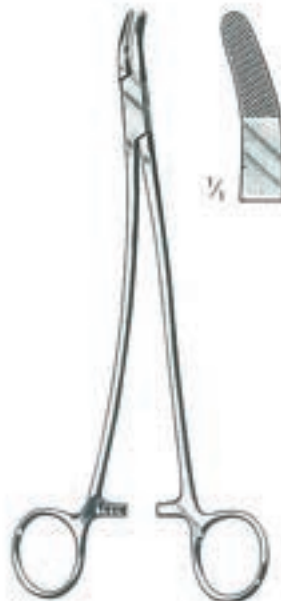

STRATTE
24.330.23 23 cm 24.334.23



CRILE
24.350.15
15 cm



TOENNIS
24.360.18 18cm 24.364.18

Nadelhalter
Needle Holders
Porte-aiguilles
Porta-agujas
Port'aghi



HOESEL
24.367.25
25 cm



cm	MATHIEU		MATHIEU		MATHIEU	
14	24.370.14	24.374.14			24.390.14	24.394.14
17	24.370.17	24.374.17	24.380.17	24.384.17	24.390.17	24.394.17
20	24.370.20	24.374.20				
24	24.370.24	24.374.24	24.380.20	24.384.20		



OLSEN-HEGAR
24.410.14 14 cm 24.414.14
24.410.18 18 cm 24.414.18



OLSEN-HEGAR
24.420.17 17 cm 24.424.17



GILLIES
24.430.16 16 cm 24.434.16



24

Nadelhalter
Needle Holders
Porte-aiguilles
Porta-agujas
Port'aghi

Gefäß-Chirurgie
Vascular surgery
Chirurgie vasculaire
Cirugia vascular
Chirurgia vascolare



Mit TC-Einsätzen
TC Lined
A mors TC
Con bocas TC
Con morso TC

cm	DIETHRICH
16	24.444.16
18	24.444.18
20	24.444.20
23	24.444.23
26	24.444.26

Ophthalmologie
Ophthalmology
Ophtalmologie
Orfalmologia
Ofthalmologia



STEVENS
24.610.11
11 cm



cm	STEVENS
13	24.612.13
15	24.612.15



BOYNTON
24.614.12
12 cm



ARRUGA
24.620.16 16cm **24.624.16**

Nadelhalter
Needle Holders
Porte-aiguilles
Porta-agujas
Port'aghi



KALT-ARRUGA
24.627.14
14 cm



KALT
24.628.14
14 cm



BARRAQUER
24.650.10
10 cm



BARRAQUER
24.651.10
10 cm



BARRAQUER
24.661.13 13 cm **24.665.13**



CASTROVIEJO
24.670.14 14 cm 24.671.14
24.674.14 14 cm **24.675.14**



CASTROVIEJO
24.680.13 13 cm **24.684.13**

26

Unterbindungsnadeln
Ligature Needles
Aiguilles à ligatures
Agujas para ligaduras
Aghi per legature



R	DESCHAMPS	L
26.110.21	21 cm	26.111.21
26.110.24	24 cm	26.111.24
26.110.27	27 cm	26.111.27



R	DESCHAMPS	L
26.120.21	21 cm	26.121.21
26.120.24	24 cm	26.121.24
26.120.27	27 cm	26.121.27

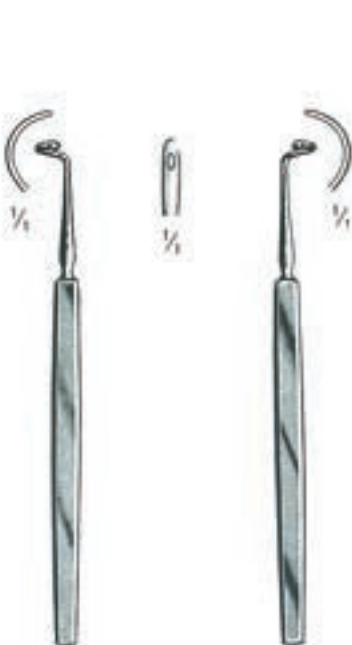

R	KRONECKER	L
26.130.13	13 cm	26.131.13



R	NELSON	L
26.133.24	24,5 cm	26.135.24

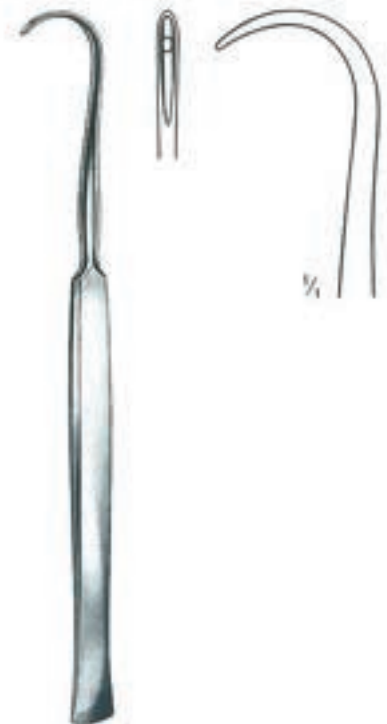

Cooper	26.139.19	19 cm
--------	-----------	-------

Naht-Instrumente
Suturing Instruments
Instruments à sutures
Instrumentos para suturas
Strumenti per suture



REVERDIN	cm	Fig. 1	Fig. 2	Fig. 3	Fig. 4
26.201.15-26.204.23	15	26.201.15	26.202.15	26.203.15	26.204.15
	19	26.201.19	26.202.19	26.203.19	26.204.19
	21	26.201.21	26.202.21	26.203.21	26.204.21
	23	26.201.23	26.202.23	26.203.23	26.204.23



YOUNG Boomerang
26.240.00
25 cm



Fig. 1
26.240.01



Fig. 2
26.240.02



Fig. 3
26.240.03

26

Führungs-Hohlsonden
Ligature Conductors
Sondes conductrices
Sondas conductoras
Sonde conduttrici



SCHMIEDEN
 26.271.19
 19 cm



SCHMIEDEN-PAYR
 26.273.19
 19 cm



BRUNNER
 26.275.30
 30 cm



KIRSCHNER
 26.277.25
 25,5 cm



KOENIG
 26.285.20
 20 cm



PAYR 26.288.22 22 cm
PAYR 26.289.22 22 cm



Plastik
 from plastic material
 matière plastique
 de materia plástica
 in plastica

cm	BRUNNER
18	26.291.18
27	26.291.27

Chirurgie-Instrumente
Surgical Instruments
Instruments de chirurgie
Instrumentos quirúrgicos
Strumenti per chirurgia

26

Nähnadeln
Suturing Needles
Aiguilles à suture
Agujas para suturas
Aghi per suture

In Packungen zu 1 Dutzend
in packages of 1 dozen
en enveloppes de 1 douzaine
en sobres de 1 dozana
bustine di 1 dozzina



26.403.01 - 26.403.16



26.413.01 - 26.413.16



26.423.01 - 26.423.16

Alle Nadeln mit Federöhr
all the needles with spring eye
toutes les aiguilles à chas à ressort
todas las agujas con ojo de resorte
tutti gli aghi con cruna aperta



26.433.01 - 26.433.09

Fig.	1	2	3	4	5	6	7	8	9	10	11	12	13	14	15	16
A	26.403.01	26.403.02	26.403.03	26.403.04	26.403.05	26.403.06	26.403.07	26.403.08	26.403.09	26.403.10	26.403.11	26.403.12	26.403.13	26.403.14	26.403.15	26.403.16
B	26.413.01	26.413.02	26.413.03	26.413.04	26.413.05	26.413.06	26.413.07	26.413.08	26.413.09	26.413.10	26.413.11	26.413.12	26.413.13	26.413.14	26.413.15	26.413.16
G	26.423.01	26.423.02	26.423.03	26.423.04	26.423.05	26.423.06	26.423.07	26.423.08	26.423.09	26.423.10	26.423.11	26.423.12	26.423.13	26.423.14	26.423.15	26.423.16
Ga	26.433.01	26.433.02	26.433.03	26.433.04	26.433.05	26.433.06	26.433.07	26.433.08	26.433.09							

Nähnadeln
Suturing Needles
Aiguilles à suture
Agujas para suturas
Aghi per suture



KOENIG
26.441.01 - 26.441.12



26.443.30 - 26.443.05



KEITH
26.450.01 - 26.450.06

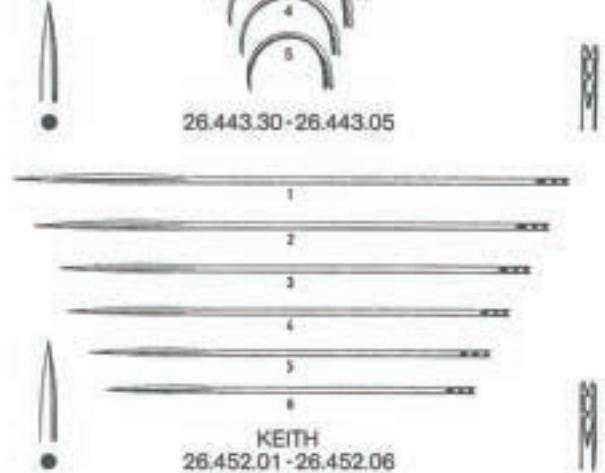

KEITH
26.452.01 - 26.452.06

Alle Nadeln mit Federöhr
all the needles with spring eye
toutes les aiguilles à chas à ressort
todas las agujas con ojo de resorte
tutti gli aghi con cruna aperta



26.465.20 - 26.467.05 Pb



26.475.20 - 26.477.05 Pc



26.485.20 - 26.487.05 Pd

Fig	000	00	0	1	2	3	4	5	6	7	8	9	10	11	12
KOENIG				26.441.01	26.441.02	26.441.03	26.441.04	26.441.05	26.441.06	26.441.07	26.441.08	26.441.09	26.441.10	26.441.11	26.441.12
E	26.443.30	26.443.20	26.443.10	26.443.01	26.443.02	26.443.03	26.443.04	26.443.05							
KEITH				26.450.01	26.450.02	26.450.03	26.450.04	26.450.05	26.450.06						
KEITH				26.452.01	26.452.02	26.452.03	26.452.04	26.452.05	26.452.06						
Pb		26.465.20	26.466.10	26.467.01	26.467.02	26.467.03	26.467.04	26.467.05							
Pc		26.475.20	26.475.10	26.477.01	26.477.02	26.477.03	26.477.04	26.477.05							
Pd		26.485.20	26.485.10	26.487.01	26.487.02	26.487.03	26.487.04	26.487.05							

Wundklammern, -instrumente
Clips and Instruments
Agrafes et instruments
Agrafes e instrumentos
Agrafes e strumenti



MICHEL
26.610.12
12 cm



WACHENFELDT
26.612.12
12,5 cm



WACHENFELDT
26.614.12
12,5 cm



HEGENBARTH
26.616.12
12,5 cm



CHILDE
26.620.18
18 cm



MICHEL
26.630.12
12 cm



MICHEL
26.631.13
13 cm



COLLIN
26.640.13
13 cm



RICHTER-HEATH
26.642.14
14 cm



MICHEL

	mm
26.660.07	7,5x1,75
26.660.11	11x2
26.660.12	12x3
26.660.14	14x3
26.660.16	16x3
26.660.18	18x3
26.660.20	20x3
26.660.22	22x3

Taschen-, Nahtbestecke
Pocket, Suturing Kits
Trousse à poche et à suture
Estuche de bolsillo y de sutura
Astucci tascabili e per sutura



Standard
26.680.00
165 x 90 x 28 mm

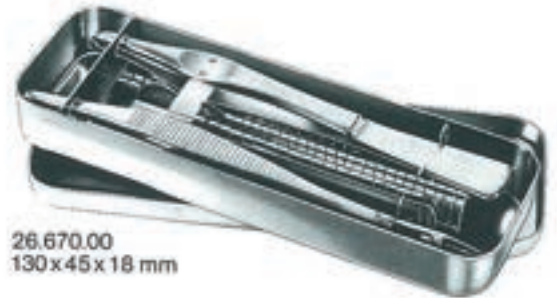

26.670.00
130 x 45 x 18 mm

Sterilisationsinstrumente
Sterilization Instruments
Instruments à stérilisation
Instrumentos para la esterilización
Strumenti per la sterilizzazione



cm	DAVIS
16	28.102.16
20	28.102.20
24	28.102.24



CHEATLE
28.110.27
27 cm



Universal		
28.120.20	20 cm	28.121.20
28.120.28	28 cm	28.121.28



ROGGE
28.130.23
23 cm



cm	
20	28.140.20
30	28.140.30



BUNT
28.150.12
12 cm



MAYO
28.152.14
14 cm

Gipsverband
Plaster of Paris
Appareils plâtrés
Vendajes enyesados
Bendaggi gessati

30



STILLE
30.101.24
24 cm



cm	STILLE
23	30.103.23
26	30.103.26
37	30.103.37



WIGMORE
30.120.19
19 cm



ENGEL
30.130.14



BERGMANN
30.134.18

Elektrische Gipssäge
Electric Plaster Cast Cutter
Scie électrique à plâtre
Sierra eléctrica para yesos
Sega elettrica per gessi

30



Volt	
110	30.210.21
220	30.210.22
compl.	

Ø	Typ	
50	30.210.50	normal
50	30.211.50	hart/hard/dure/dura
65	30.210.65	normal
65	30.211.65	hart/hard/dure/dura



30.212.02

Gipsverband
Plaster of Paris
Appareils plâtrés
Vendajes enyesados
Bendaggi gessati



HENNIG
30.350.28
28 cm

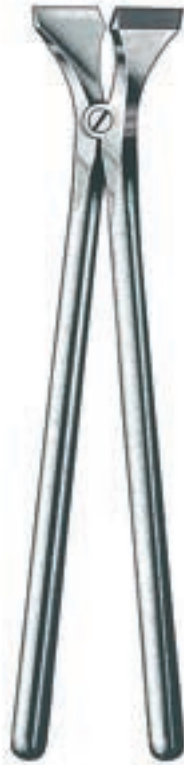

BEESON
30.360.30
30 cm



HAGLUND-STILLE
30.362.28
28 cm



30.366.23
23 cm



HOPKINS
30.370.20
20 cm



ESMARCH
30.380.18
18 cm



REINER
30.390.18
18 cm



WOLFF
30.395.18
18 cm



WOLFF
30.397.24
24 cm

Hohlmeißelzangen
Bone Rongeurs
Pincès-gouges
Pinzas-gubias
Pinze sgorbie



FRIEDMAN Mini
32.101.12
12 cm



FRIEDMAN
32.101.14
14 cm



FRIEDMAN
32.102.14
14 cm



CLEVELAND
32.103.14
14 cm Fig. 4



CLEVELAND
32.105.17
17 cm Fig. 4 A



MEAD
32.107.16
16,5 cm Fig. 1 A



MEAD
32.109.16
16,5 cm



BLUMENTHAL
32.115.15
15,5 cm



BLUMENTHAL
32.117.15
15,5 cm

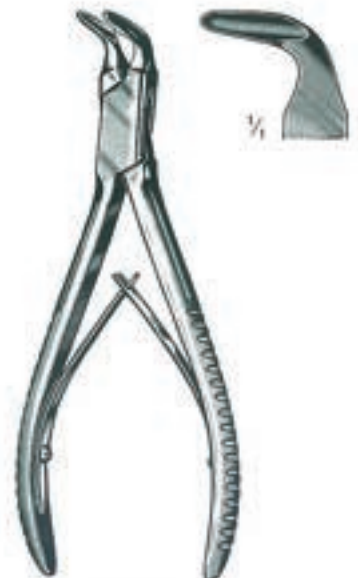

BLUMENTHAL
32.119.15
15,5 cm

32

Hohlmeißelzangen
Bone Rongeurs
Pincés-gouges
Pinzas-gubias
Pinze sgorbie



LUER
32.131.15
15 cm



LUER
32.133.15
15 cm

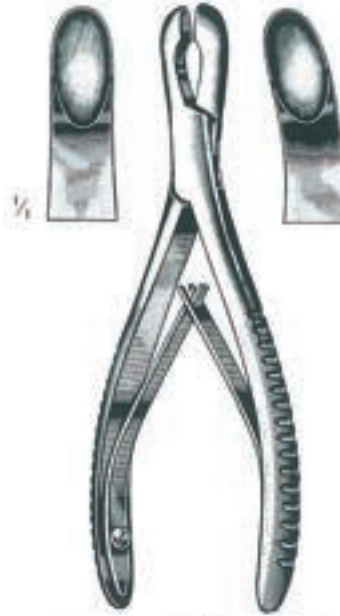

LUER
32.136.17 17 cm 32.137.17



ADSON
32.142.20 20 cm 32.143.20



OLIVECRONA
32.147.20
20 cm



LEMPERT
32.150.16 16 cm 32.151.16



LEMPERT
32.154.18 18,5cm 32.155.18

Hohlmeißelzangen
Bone Rongeurs
Pincès-gouges
Pinzas-gubias
Pinze sgorbie



BEYER
32.201.18
18 cm



ZAUFAL-JANSEN
32.205.18
18 cm



BOHLER
32.210.15 15 cm/2 mm 32.211.15
32.212.15 15 cm/3 mm 32.213.15



RUSKIN
32.216.18 18 cm 32.217.18



RUSKIN
32.218.23 23 cm 32.219.23

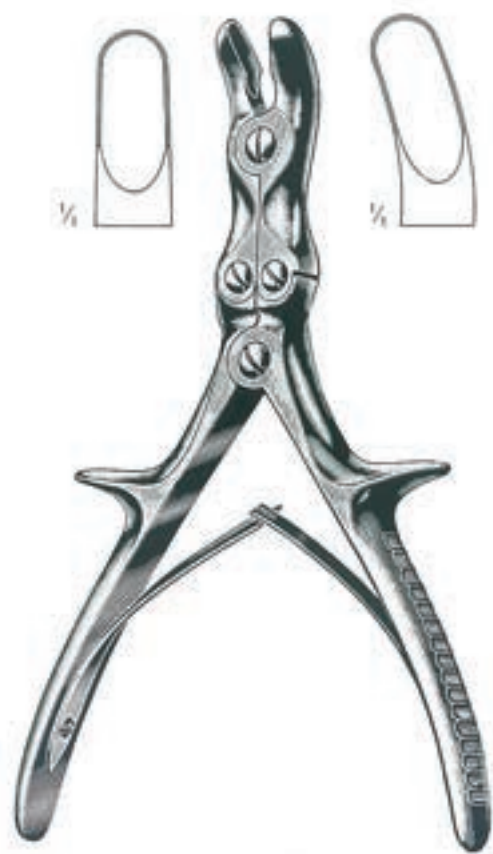

STILLE-LUER
22 cm 32.231.22
32.230.26 26 cm 32.231.26



STILLE-LUER
32.235.23
23 cm

32

Hohlmeißelzangen
Bone Rongeurs
Pinces-gouges
Pinzas-gubias
Pinze sgorbie



STILLE-RUSKIN
32.237.23
23 cm

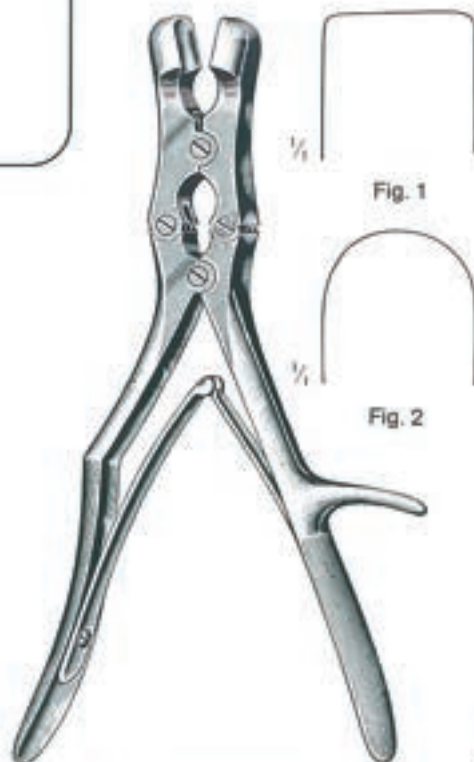

Fig.	SAUERBRUCH
1	32.241.30
2	32.243.30
	30 cm



Fig.	LEKSELL (STILLE)
1	32.245.23
2	32.247.23
	23 cm



R	SCAGLIETTI	L
32.251.26	26 cm	32.253.26
à droite		à gauche
derecha		izquierda
a destra		a sinistra



FRYKHOLM
32.255.24
24 cm



mm	ECHLIN
2	32.259.02
3	32.259.03
4	32.259.23
	23 cm

Knochensplitterzangen
Bone Cutting Forceps
Pinces coupantes à os
Pinzas cortantes para huesos
Cesioie per ossa



cm	SEMB
22,5	32.261.22
27,0	32.261.27

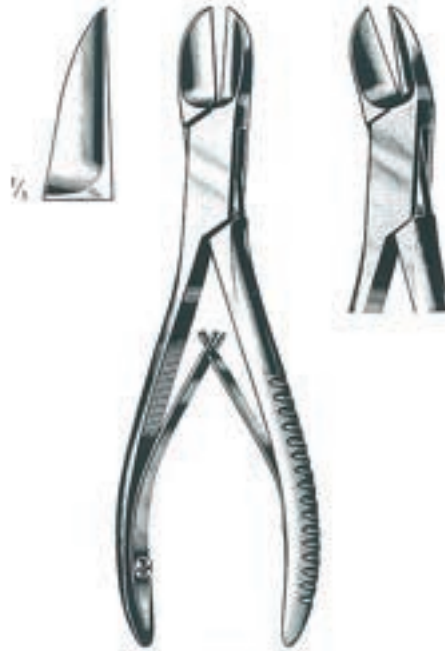

LISTON			
32.274.14	14 cm	32.275.14	
32.274.17	17 cm	32.275.17	
32.274.19	19 cm	32.275.19	
32.274.22	22 cm	32.275.22	



BÖHLER		
32.280.15	15 cm	32.281.15



COTTLE-KAZANJIAN
32.282.19
19 cm



RUSKIN-LISTON		
32.286.18	18,5cm	32.289.18

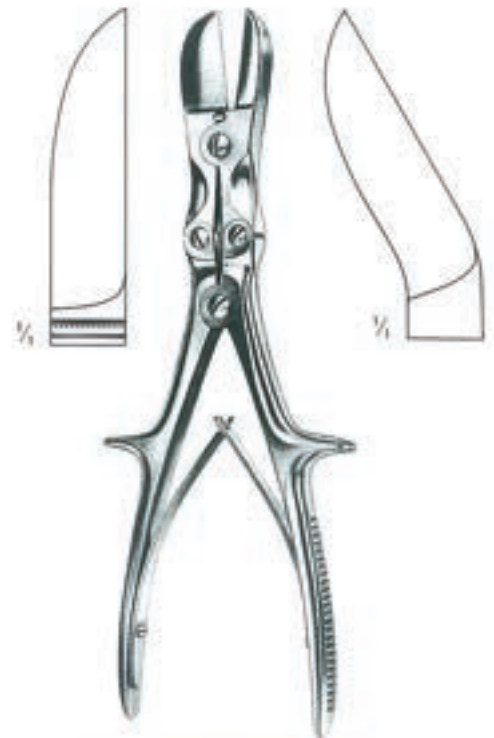

STILLE-LISTON		
32.290.27	27 cm	32.291.27

32

Knochensplitterzangen
Bone Cutting Forceps
Pincès coupantes à os
Pinzas cortantes para huesos
Cesoie per ossa



STILLE-HORSLEY
32.293.27
27 cm

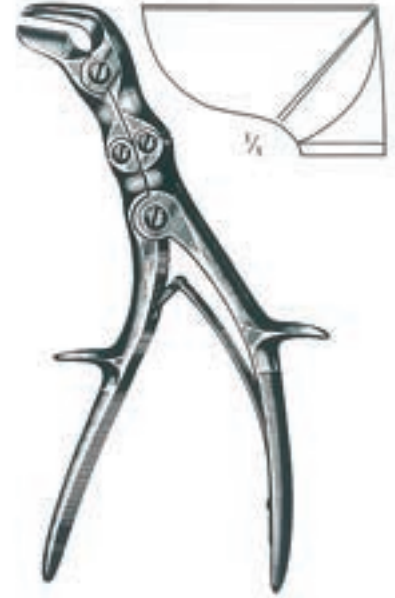

SEMB
32.295.24
24 cm

Knochenhalte-zangen
Bone Holding Forceps
Daviers porte-os
Pinzas para huesos
Tenaglie per ossa

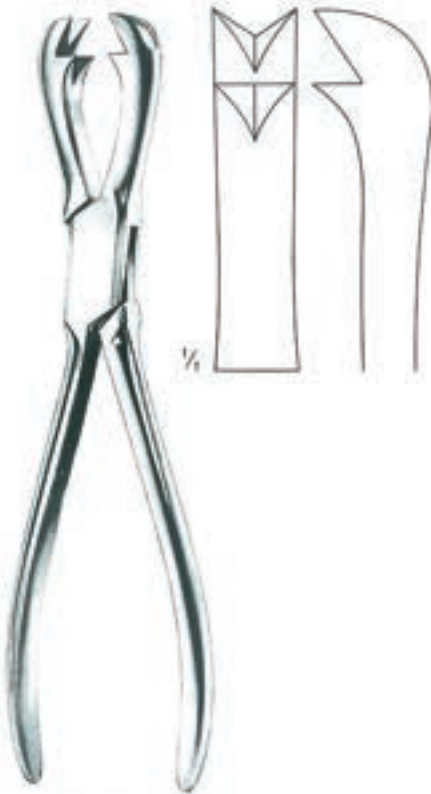

FERGUSON
32.360.21
21 cm



LANGENBECK
32.362.21
21 cm

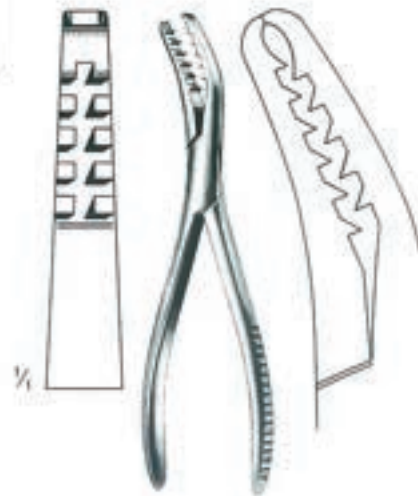

SEMB
32.365.19
19 cm



cm	FARABEU
23	32.366.23
26	32.366.26

Knochenhalte­zangen
 Bone Holding Forceps
 Daviers porte-os
 Pinzas para huesos
 Tenaglie per ossa



FARABEU­F-LAMBOTTE
 32.368.26
 26 cm



cm	LAMBOTTE
22	32.370.22
27	32.370.27
30	32.370.30



cm	LAMBOTTE
22	32.372.22
26	32.372.26
33	32.372.33



cm	LAMBOTTE
19	32.373.19
23	32.373.23
26	32.373.26



cm	KERN	KERN
15	32.378.15	32.380.15
17	32.378.17	32.380.17
21	32.378.21	32.380.21



cm	LANE
33	32.382.33
45	32.382.45

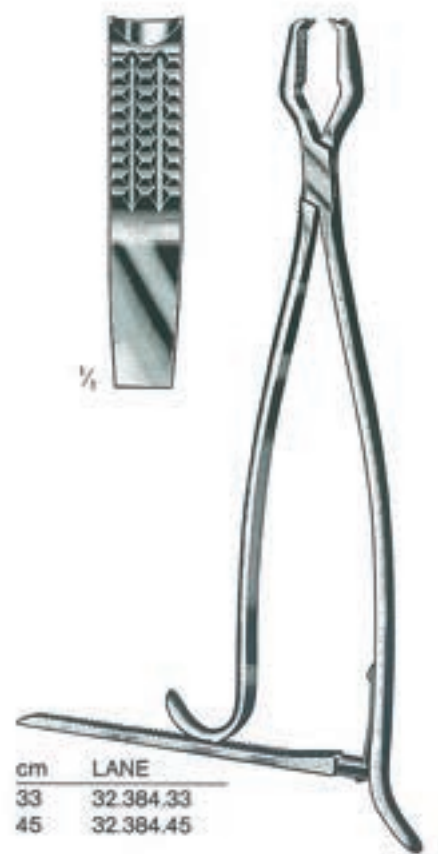

cm	LANE
33	32.384.33
45	32.384.45

32

Knochenhaltezaugen
Bone Holding Forceps
Daviers porte-os
Pinzas para huesos
Tenaglie per ossa



32.391.15-32.391.28

Selbstzentrierend
self-centering
autocentrant
autocentrantes
autocentranti



32.391.15
15 cm



32.391.19
19 cm



32.391.24
24 cm



32.391.26
26 cm



32.391.28
28 cm



VERBRUGGE
32.395.17-32.395.27



32.395.17
17,5 cm

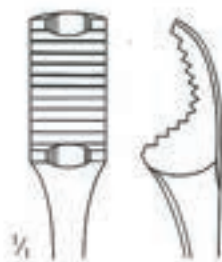

32.395.25
25 cm

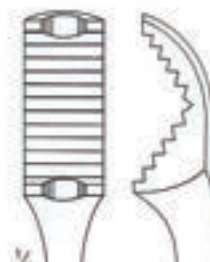

32.395.26
26 cm

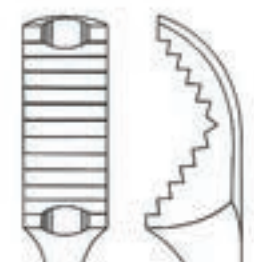

32.395.27
27 cm

Knochenhalte-, Sequesterzangen
Bone Holding, Sequester Forceps
Pincès à os, à séquestres
Pinzas para huesos y secuestros
Pinze per ossa e sequestri



LEWIN
32.402.17
17,5 cm

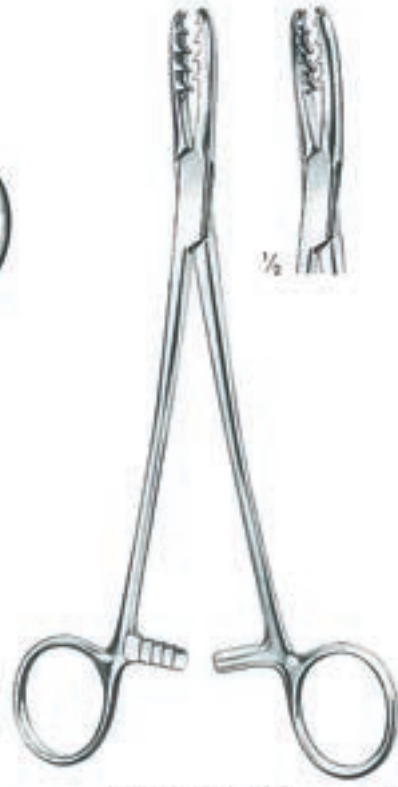

BIRCHER-GANSKE
32.404.20 20 cm 32.405.20

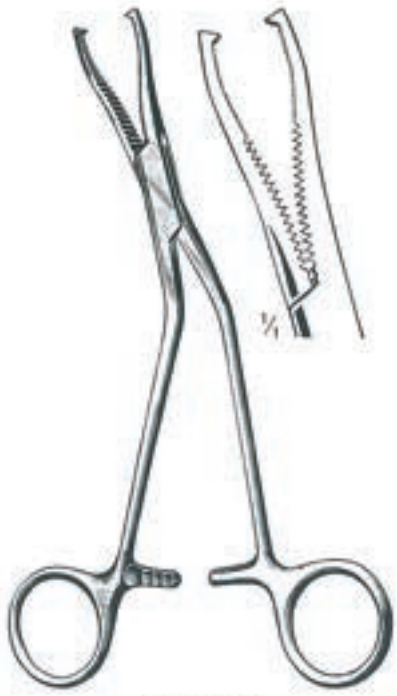

DINGMANN
32.407.19
19 cm



32.409.13
13,5 cm



MARTIN
32.410.19
19 cm

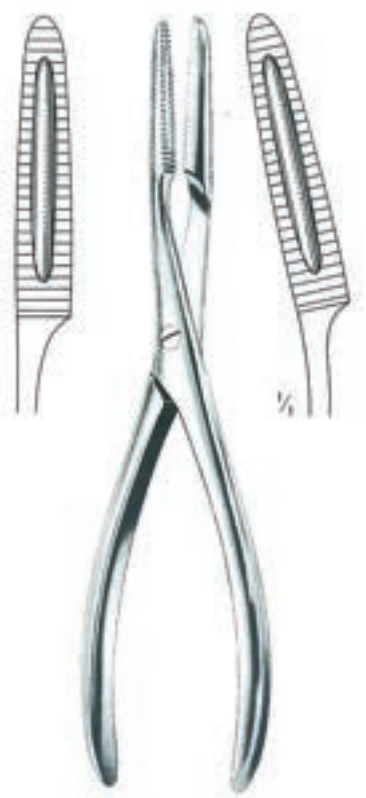

32.420.20 20 cm 32.421.20

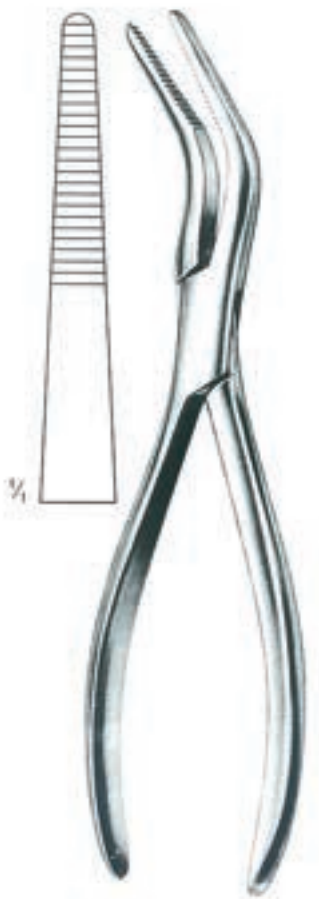

VAN BUREN
32.423.23
23 cm

32

Knochenchirurgie
Bone Surgery
Chirurgie osseuse
Cirugia ósea
Chirurgia ossea



cm	LOWMAN
13	32.441.13
18,5	32.441.18
20	32.441.20

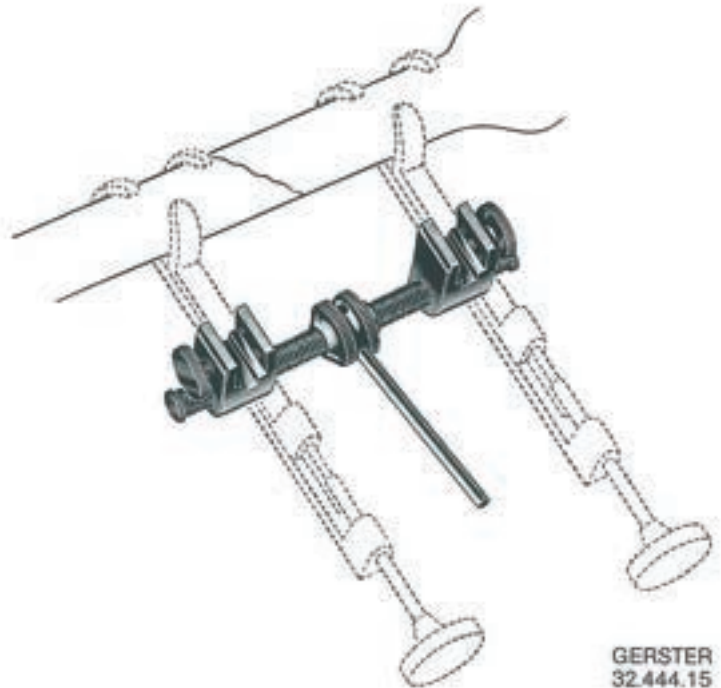

GERSTER
32.444.15



PARHAM
32.446.24



cm	PARHAM
18	32.448.18
30	32.448.30



32.450.01 f. Erwachsene
adult size
p. adultes
p. adultos
p. adulti
32.450.02 f. Kinder
child size
p. enfants
p. niños
p. bambini

Scharfe Löffel
Bone Curettes
Curettes à os
Cucharillas cortantes
Curette taglienti



SCHEDE
32.467.97-32.468.04

SCHEDE	Fig.	VOLKMANN
	0000	32.469.96
32.467.97	000	32.469.97
32.467.98	00	32.469.98
32.468.00	0	32.470.00
32.468.01	1	32.470.01
32.468.02	2	32.470.02
32.468.03	3	32.470.03
32.468.04	4	32.470.04
	5	32.470.05
	6	32.470.06

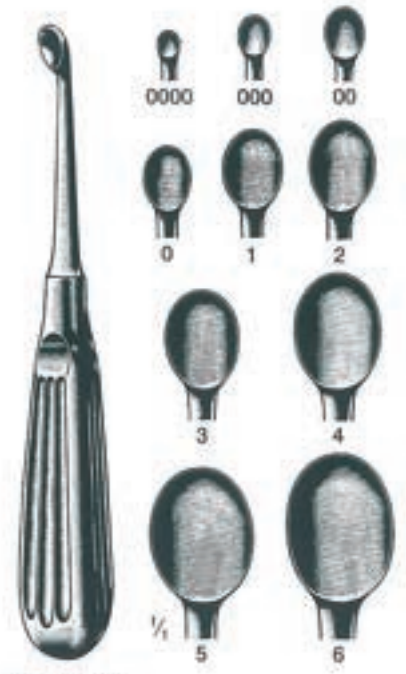

VOLKMANN
32.469.96-32.470.06



BRUNS
32.471.96-32.472.06

BRUNS	Fig.	SPRATT
32.471.96	0000	
32.471.97	000	32.474.97
32.471.98	00	32.474.98
32.472.00	0	32.475.00
32.472.01	1	32.475.01
32.472.02	2	32.475.02
32.472.03	3	32.475.03
32.472.04	4	32.475.04
32.472.05	5	32.475.05
32.472.06	6	



SPRATT
32.474.97-32.475.05

Scharfe Löffel
Bone Currettes
Curettes à os
Cucharillas cortantes
Curette taglienti

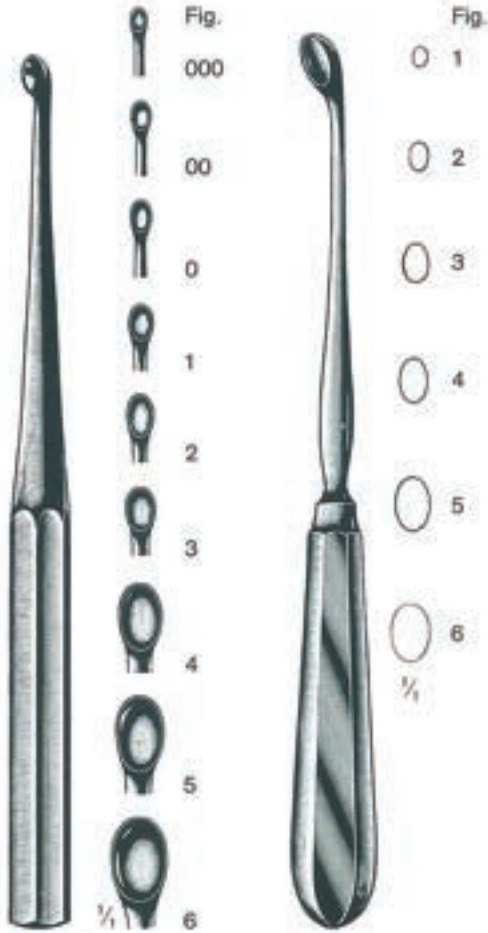

Fig.	BRUNS 23 cm	SIMON 24 cm
000	32.480.97	
00	32.480.98	
0	32.481.00	
1	32.481.01	32.485.01
2	32.481.02	32.485.02
3	32.481.03	32.485.03
4	32.481.04	32.485.04
5	32.481.05	32.485.05
6	32.481.06	32.485.06

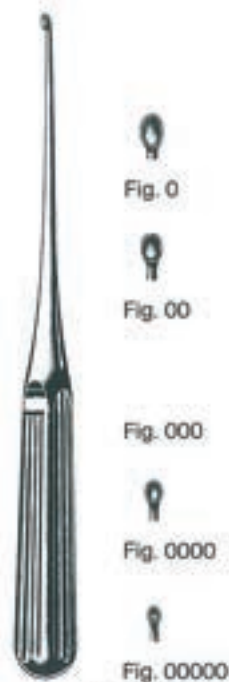

Fig.	LEMPERT 17,5 cm
0	32.490.10
00	32.490.20
000	32.490.30
0000	32.490.40
00000	32.490.50



Fig.	HALLE 21 cm
1	32.491.01
2	32.491.02
3	32.491.03



cm	VOLKMANN
13	32.492.13
16	32.492.16
20	32.492.20



cm	VOLKMANN
13	32.494.13
14	32.494.14
17	32.494.17

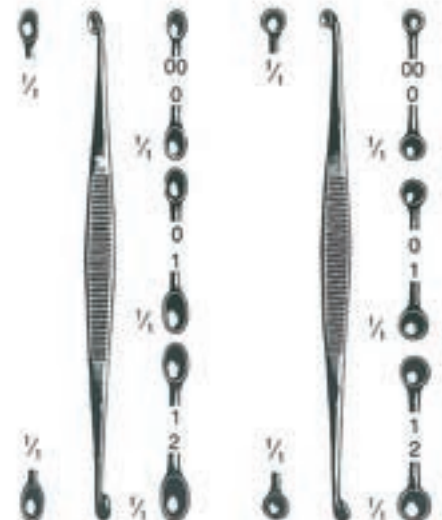
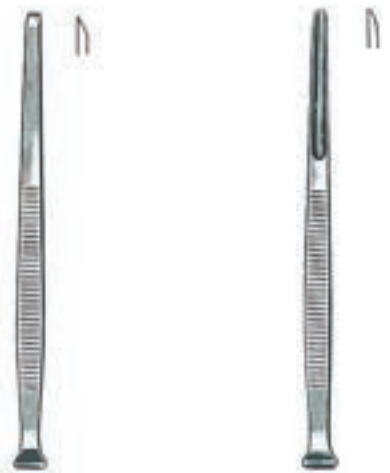

Fig.	WILLIGER 13,5 cm	MARTINI 13,5 cm
00/0	32.496.00	32.498.00
0/1	32.496.01	32.498.01
1/2	32.496.12	32.498.12

Knochenmeißel
Bone Chisels and Gouges
Ciseaux-burins, gouges
Cinceles, gubias
Scalpelli, sgorbie



mm	13,5 cm	13,5 cm	13,5 cm	ALEXANDER 17 cm	ALEXANDER 17 cm
4				32.610.04	32.611.04
6				32.610.06	32.611.06
8	32.602.08	32.604.08	32.605.08	32.610.08	32.611.08
10	32.602.10	32.604.10	32.605.10	32.610.10	32.611.10
12	32.602.12	32.604.12	32.605.12	32.610.12	32.611.12
14	32.602.14	32.604.14	32.605.14	32.610.14	32.611.14
16	32.602.16	32.604.16	32.605.16		



mm	PARSCH		PARSCH	
	13,5 cm	17 cm	13,5 cm	17 cm
2	32.620.02	32.622.02	32.623.02	32.625.02
3	32.620.03	32.622.03	32.623.03	32.625.03
4	32.620.04	32.622.04	32.623.04	32.625.04
5	32.620.05	32.622.05	32.623.05	32.625.05
6	32.620.06	32.622.06	32.623.06	32.625.06
7	32.620.07	32.622.07	32.623.07	32.625.07
8	32.620.08	32.622.08	32.623.08	32.625.08

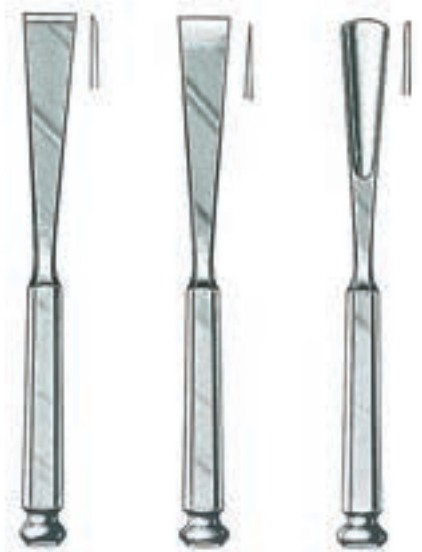

mm	STILLE		
	20 cm	20 cm	20 cm
10	32.630.10	32.632.10	32.633.10
15	32.630.15	32.632.15	32.633.15
20	32.630.20	32.632.20	32.633.20
25	32.630.25	32.632.25	32.633.25

Knochenmeißel
Bone Chisels and Gouges
Ciseaux-burins, gouges
Cinceles, gubias
Scalpelli, sgorbie



SMITH-PETERSEN					LAMBOTTE			LAMBOTTE mini	
mm					mm				
6	32.634.06	32.635.06	32.637.06	32.639.06	6,5	32.650.06	32.651.06	3	32.654.03
9	32.634.09	32.635.09	32.637.09	32.639.09	15,0	32.650.15	32.651.15	4	32.654.04
13	32.634.13	32.635.13	32.637.13	32.639.13	20,0	32.650.20	32.651.20	6	32.654.06
16	32.634.16	32.635.16	32.637.16	32.639.16	25,0	32.650.25	32.651.25	8	32.654.08
19	32.634.19	32.635.19	32.637.19	32.639.19	30,0	32.650.30	32.651.30	10	32.654.10
25	32.634.25	32.635.25	32.637.25	32.639.25	38,0	32.650.38	32.651.38	12	32.654.12
32	32.634.32	32.635.32	32.637.32	32.639.32	44,0	32.650.44	32.651.44	15	32.654.15
	20 cm	20 cm	20 cm	20 cm		24 cm	23 cm		12,5 cm

Knochenmeißel
Bone Chisels and Gouges
Ciseaux-burins, gouges
Cinceles, gubias
Scalpelli, sgorbie

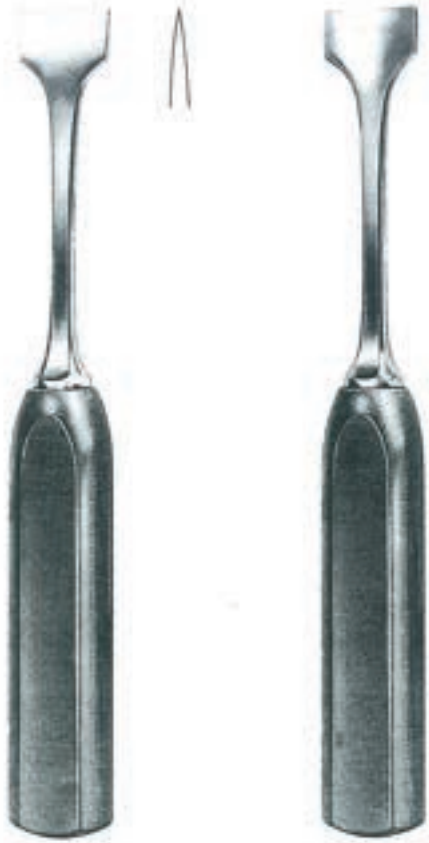

mm	LEXER	LEXER
7	32.660.07	32.661.07
10	32.660.10	32.661.10
15	32.660.15	32.661.15
20	32.660.20	32.661.20
25	32.660.25	32.661.25
30	32.660.30	32.661.30
	22 cm	22 cm

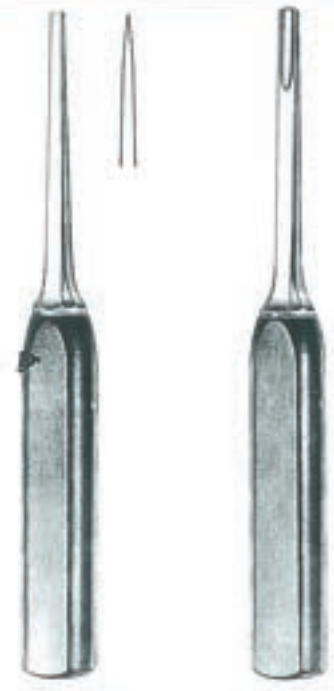

mm	LEXER mini	LEXER mini
4	32.664.04	32.665.04
6	32.664.06	32.665.06
8	32.664.08	32.665.08
10	32.664.10	32.665.10
12	32.664.12	32.665.12



mm	HOKE
3	32.668.03
5	32.668.05
6	32.668.06
8	32.668.08
9	32.668.09
	17 cm

mm	HIBBS				
6	32.670.06	32.672.06	32.671.06	32.673.06	32.675.06
13	32.670.13	32.672.13	32.671.13	32.673.13	32.675.13
19	32.670.19	32.672.19	32.671.19	32.673.19	32.675.19
25	32.670.25	32.672.25	32.671.25	32.673.25	32.675.25
32	32.670.32	32.672.32	32.671.32	32.673.32	32.675.32
	24 cm	24 cm	24 cm	24 cm	24 cm

32

Knochenmeißel
Bone Chisels and Gouges
Ciseaux-burins, gouges
Cinceles, gubias
Scalpelli, sgorbie



LEBSCHKE
32.678.24
24,5 cm



32.679.22
22 cm



VIRCHOW
32.680.12



BRUNETTI
32.681.28
28 cm



BRUNETTI
32.683.28
28 cm

Autopsie-Besteck
Post Mortem Set
Set à autopsie
Juego de autopsia
Set per autopsia



32.684.00

Hämmer
Bone Hammers and Mallets
Maillets
Martillos y mazos
Martelli



GERZOG
32.686.25
18 cm 250 g



KIRK
32.688.75
19 cm 750 g



g	
450	32.690.45
900	32.690.90
	26,5 cm



COLLIN
32.692.22
20 cm 220 g



WILLIGER
32.694.34
24 cm 340 g

32.697.02
Pair Ersatzbacken
Pair of Spare Faces
Paire de faces de rechange
Pareja de tapas intercambiables
Coppia di teste di ricambio



LUCAE
32.696.26
19 cm 260 g



MEAD
32.696.32
17 cm 320 g



g	
250	32.698.25
400	32.698.40
	26 cm



QUISLING
32.698.75



32.699.00
23,5 cm

Raspatorien
Periosteal Elevators
Rugines-raspatoires
Periostótomos
Periostotomi

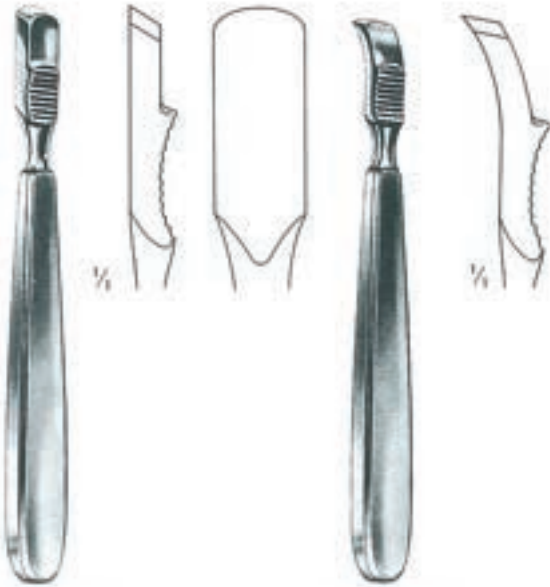

FARABEU
32.702.15
15 cm

FARABEU
32.703.15
15 cm



mm	LAMBOTTE
10	32.705.10
15	32.705.15
20	32.705.20
25	32.705.25

21 cm

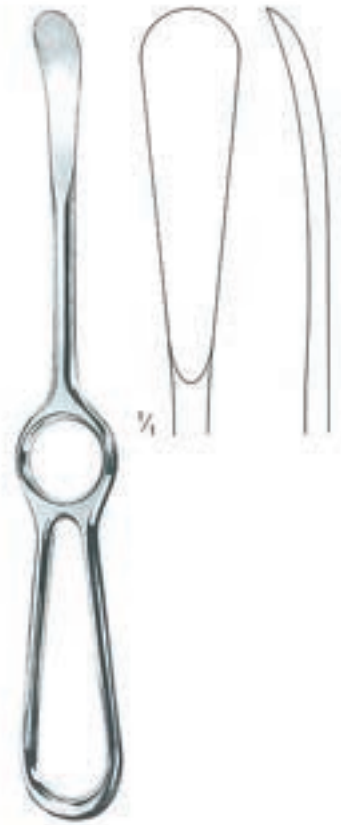

SEDILLOT
32.709.21
21 cm

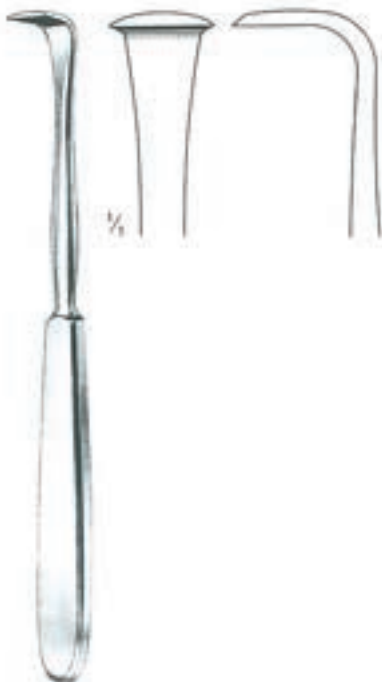

LANGENBECK
32.711.18
18 cm



WILLIGER
32.713.16
16 cm



cm	ALEXANDER
16	32.715.16
20	32.715.20

Raspatorien
Periosteal Elevators
Rugines-raspatoires
Periostótomos
Periostotomi

Für Rippen
Rib
Pour les côtes
Para costillas
Costali



DOYEN DOYEN
32.721.17 - 32.727.17
17 cm



32.721.17 32.723.17



32.725.17 32.727.17



SEMB
32.729.01 -
32.729.07



32.729.01
17,5 cm



32.729.02
21,0 cm



32.729.03
17,5 cm



32.729.04
21,0 cm



32.729.05
20,5 cm



32.729.06
20,5 cm



32.729.07
22,5 cm

32

Elevatorien
Elevators
Elévateurs
Elevadores
Elevatori



MATSON-ALEXANDER
32.731.22



MATSON
32.733.22
22 cm



OVERHOLT
32.735.29
29,5 cm



OVERHOLT
32.737.29
29,5 cm



OVERHOLT
32.739.28
28,5 cm



LANGENBECK
32.751.20
20 cm



LANGENBECK
32.753.20
20 cm



ADSON
32.754.17 -
32.757.17
17 cm



32.754.17



32.755.17



32.756.17



32.757.17



KEY
32.759.06 -
32.759.25
19 cm



mm	
6	32.759.06
12	32.759.12
19	32.759.19
25	32.759.25

Elevatori, Knochenheber
Elevators, Bone Levers
Elévateurs, Leviers à os
Elevadores, E. para huesos
Elevatori, Elevatori per ossa



WATSON-CHEYNE
32.765.17
17,5 cm



McDONALD
32.767.19
19 cm



MURPHY-LANE
32.769.30
30 cm



BENNETT
32.771.71
65x260 mm



BENNETT
32.771.73
45x260 mm



HOHMANN
32.801.08
8 mm



HOHMANN
32.801.18
18 mm



HOHMANN
32.801.43
43 mm



HOHMANN
32.801.70
70 mm

Knochenhebel
Bone Levers
Leviers à os
Elevadores para huesos
Elevatori per ossa

32



HOHMANN
32.803.43
43 mm



HOHMANN
32.805.22
22 mm



HOHMANN
32.805.33
33 mm



HOHMANN
32.807.24
24 mm



HOHMANN
32.809.22
22 mm



HOHMANN mini
32.811.06-32.811.08
16 cm



32.811.06
6 mm



32.811.08
8 mm



32.815.06
14 cm

Knochenchirurgie
Bone Surgery
Chirurgie osseuse
Cirurgia ósea
Chirurgia ossea

Knochenhebel
Bone Levers
Leviers à os
Elevadores para huesos
Elevatori per ossa



BLOUNT
32.823.26
26 cm

BLOUNT
32.825.26
26 cm



BLOUNT
32.827.17
17,5 cm



mm x mm	TAYLOR
75 x 30	32.831.16
100 x 30	32.833.16
	16,5 cm

Meniskotome - Meniscotomes
Meniscotomes - Meniscótomos
Meniscotomi

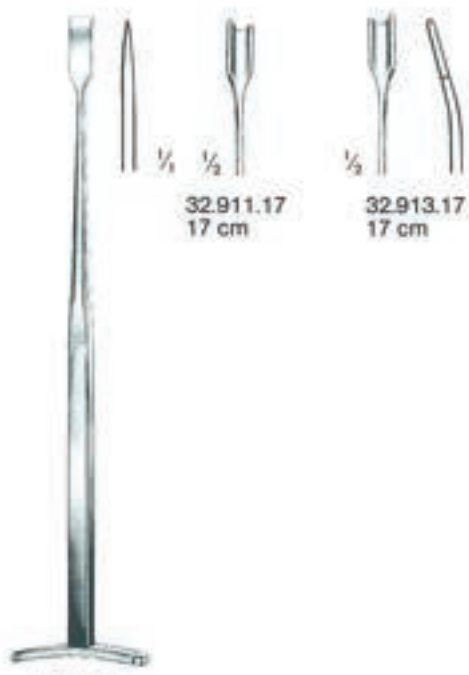

SMILLIE
32.910.17
17 cm

32.911.17
17 cm

32.913.17
17 cm



BIRCHER
32.915.19
19 cm



BIRCHER
32.917.19
19 cm

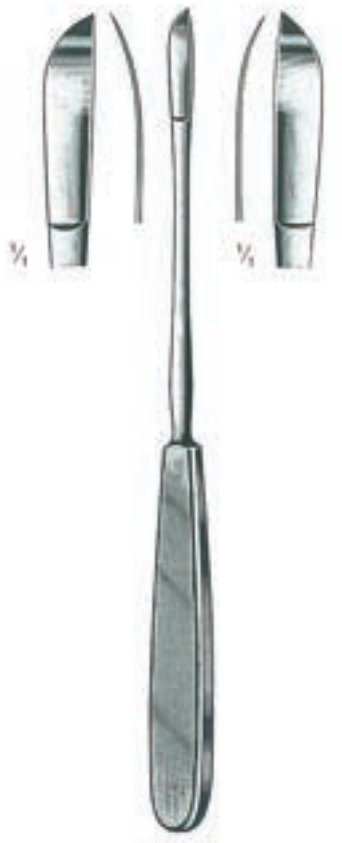

NEFF		
32.921.22	22 cm	32.923.22

Knochenchirurgie
Bone Surgery
Chirurgie osseuse
Cirugía ósea
Chirurgia ossea

Sehnenstripper, Knochenfeilen
Tendon Strippers, Bone Files
Instruments à écorcher les tendons, limes à os
Separadores para tendones, limas para huesos
Scollatendini, lime per ossa

32



BUNNELL
32.950.01 - 32.950.05
15 cm



32.971.24
24,5 cm



32.972.22
22 cm



PUTTI
32.973.27
27 cm



PUTTI
32.975.30
30 cm

Korr primeter zur Erzeugung von Blutteere in den Gliedern
Compression Apparatus for producing blood vacuum in limbs
Appareil compressif permettant d'obtenir un milieu exsangue des membres
Aparato de compresión para producir el vacío de sangre en los miembros
Vacumetro per determinare vuoti di sangue nelle membra



33.101.01
compl.

Amputation, Finger
Amputation, Fingers
Amputation, doigts
Amputación, dedos
Amputazione, dita

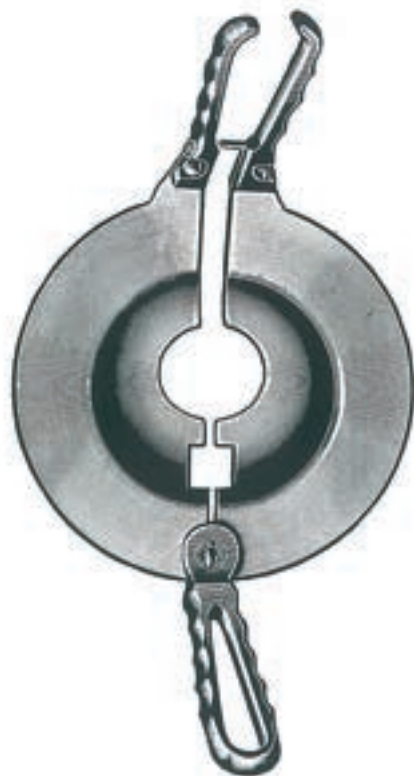

PERCY
33.110.00

mm	
3	33.112.03
5	33.112.05
7	33.112.07



CHARRIERE
33.112.00

32.116.99



CHARRIERE
33.116.30
30 cm

32.118.99



SATTERLEE
33.118.31
31 cm



LANGENBECK
33.120.23
23 cm



33.160.01



33.160.00
Compl. incl.
33.160.01

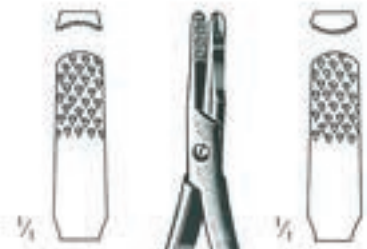

RADOLF
33.162.13
13,5 cm



33.173.01

DIMEDA
33.173.00
17 cm



33.175.01

33.175.00

Handbohrapparate
Bone Hand Drills
Perforateurs à main
Perforadores a mano
Perforatori a mano



STILLE
33.210.20
Compl. 20 cm



STILLE-SHERMAN
33.220.24
Compl. 24 cm

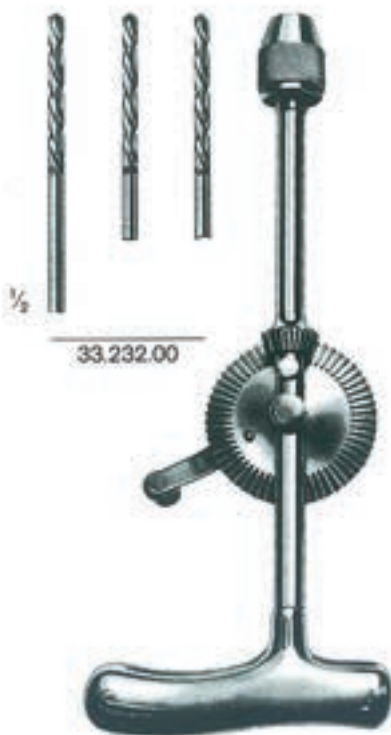

1/2
33.232.00

MOORE
33.230.28
Compl. 28 cm



HUDSON
33.240.27
Compl. incl. 33.242.09, -14, -16, -22, 33.246.00
27 cm



Handbohrapparate
Bone Hand Drills
Perforateurs à main
Perforadores a mano
Perforatori a mano

33



KIRSCHNER
33.250.00
Compl.



33.252.00



33.260.00
Compl.



33.262.00

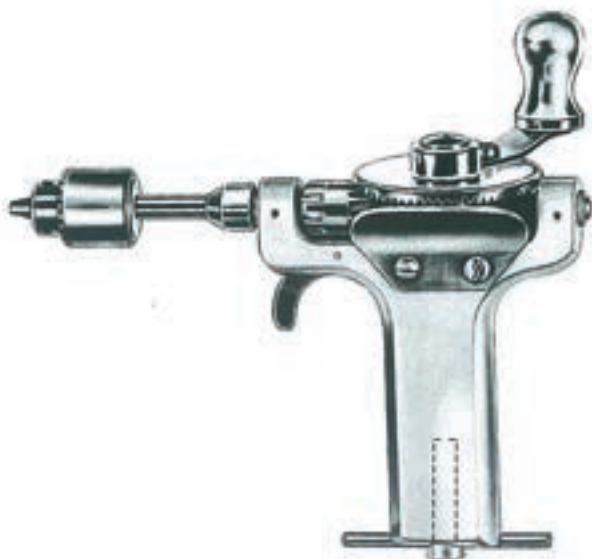

BUNNELL
33.270.00
16 cm



RALK
33.280.00

33

Bohrapparate
Bone Drills
Perforateurs à os
Perforadores para huesos
Perforatori per ossa

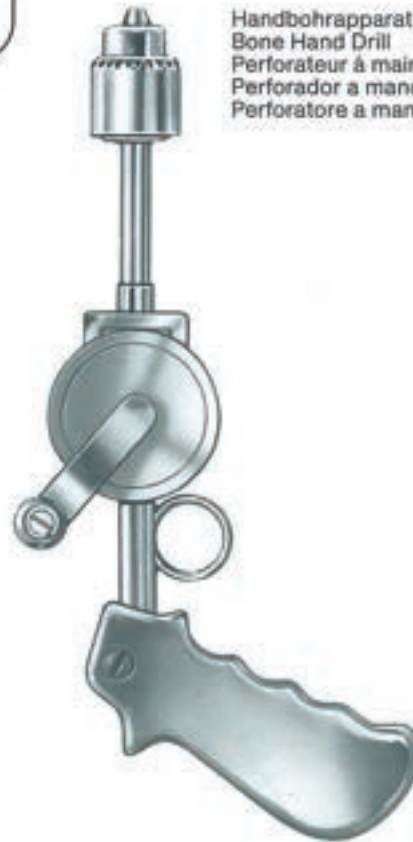

Handbohrapparat
Bone Hand Drill
Perforateur à main
Perforador a mano
Perforatore a mano

33.290.00



33.296.00

elektrisch
electrical
électrique
eléctrico
elettrico



Volt	
220	33.310.00
110	33.310.01



33.312.00

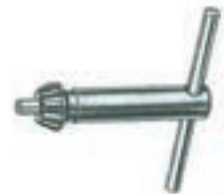

Bohrer, Fräser, Trephinen
Burr, Drills, Trephines
Mèches, fraises, trépan
Taladros, fresas, trefinas
Trapani, frese, trefine



mm			
1,0		33.352.10	33.354.10
1,2		33.352.12	
1,5		33.352.15	33.354.15
1,8		33.352.18	
2,0	33.350.20	33.352.20	33.354.20
2,2		33.352.22	
2,5	33.350.25	33.352.25	33.354.25
2,8		33.352.28	33.354.28
3,0	33.350.30	33.352.30	33.354.30
3,2	33.350.32	33.352.32	33.354.32
3,5	33.350.35	33.352.35	33.354.35
4,0	33.350.40	33.352.40	33.354.40
5,0	33.350.50	33.352.50	33.354.50
6,0	33.350.60		33.354.60
7,0	33.350.70		



mm Ø	DOYEN	DOYEN	DOYEN	DOYEN	ALBEE	ALBEE	BORCHARDT	TOTI
4	33.362.04	33.364.04						
6	33.362.06	33.364.06						
7						33.374.07		
8	33.362.08	33.364.08		33.368.08		33.372.08		33.378.08
10	33.362.10	33.364.10		33.368.10		33.372.10		
12	33.362.12	33.364.12	33.366.12		33.370.12	33.372.12		
13							33.376.13	
14	33.362.14	33.364.14						
15					33.370.15			
16	33.362.16	33.364.16						
25								33.377.25

Zubehör zum Handmotor
Accessories for Bone Engine
Accessoires p. moteur à main
Accesorios para motor a mano
Accessori p. motore a mano

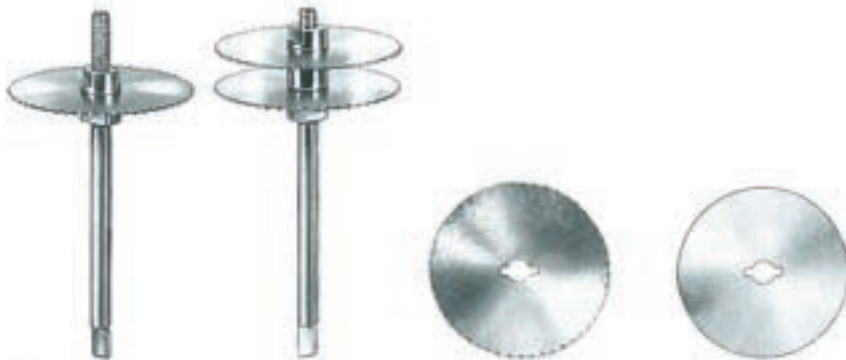

mm Ø			
20	33.380.20	33.382.20	33.384.20
25	33.380.25	33.382.25	33.384.25
30	33.380.30	33.382.30	33.384.30
35	33.380.35	33.382.35	33.384.35
40	33.380.40	33.382.40	33.384.40
45	33.380.45	33.382.45	33.384.45
50	33.380.50	33.382.50	33.384.50

mm Ø		
17	33.386.17	
22	33.386.22	
27	33.386.27	
32	33.386.32	
37	33.386.37	
42	33.386.42	
47	33.386.47	

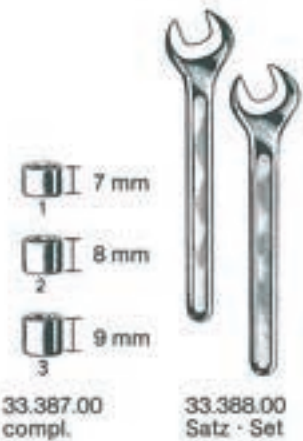

33.387.00
compl.

33.388.00
Satz · Set



33.390.00
compl.



33.392.14
14 cm



PERTHES
33.395.21
21 cm

Bohrdrähte
Wire Drills
Broches de KIRSCHNER
Taladros filiformes
Fili KIRSCHNER

33



Trokarspitze
Trocar tip
Pointe trocart
Punta en forma de trócar
Punte a trequarti

mm Ø	L = 60 mm	L = 120 mm	L = 140 mm	L = 160 mm	L = 310 mm
1,0	33.406.10	33.412.10	33.414.10	33.416.10	33.431.10
1,2	33.406.12	33.412.12	33.414.12	33.416.12	33.431.12
1,4	33.406.14	33.412.14	33.414.14	33.416.14	33.431.14
1,5	33.406.15	33.412.15	33.414.15	33.416.15	33.431.15
1,6	33.406.16	33.412.16	33.414.16	33.416.16	33.431.16
1,8	33.406.18	33.412.18	33.414.18	33.416.18	33.431.18
2,0	33.406.20	33.412.20	33.414.20	33.416.20	33.431.20
2,2	33.406.22	33.412.22	33.414.22	33.416.22	33.431.22
2,5				33.416.25	33.431.25

KIRSCHNER
33.406.10 - 33.431.25



Lanzenspitze
Lancet tip
Pointe lancéolaire
Punta lanceolar
Punte lanceolari

mm Ø	L = 310mm
1,0	33.432.10
1,2	33.432.12
1,5	33.432.15
1,6	33.432.16
1,8	33.432.18
2,0	33.432.20
2,2	33.432.22
2,5	33.432.25

KIRSCHNER
33.432.10 - 33.432.25

STEINMANN Nägel
STEINMANN Pins
STEINMANN clous à os
STEINMANN clavos p. huesos
STEINMANN chiodi per ossa



L cm	
13	33.490.13
14	33.490.14
15	33.490.15
16	33.490.16
18	33.490.18
20	33.490.20
21	33.490.21

STEINMANN
33.490.13 - 33.490.21

33
 Extensionsbügel
 Extension Bows
 Etriers à extension
 Estribos para extensión
 Archi per estensione

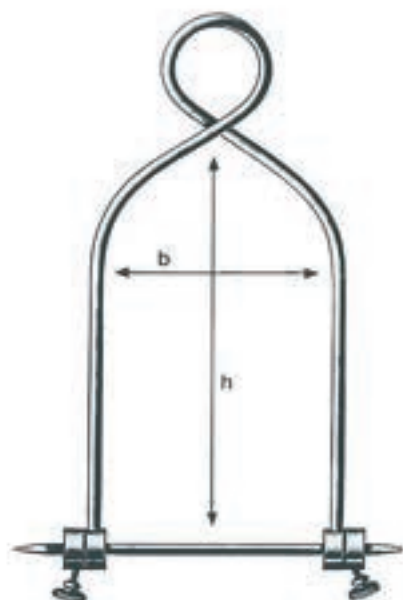

hxb cm	BOEHLER
16x 9	33.502.16
16x11	33.502.21

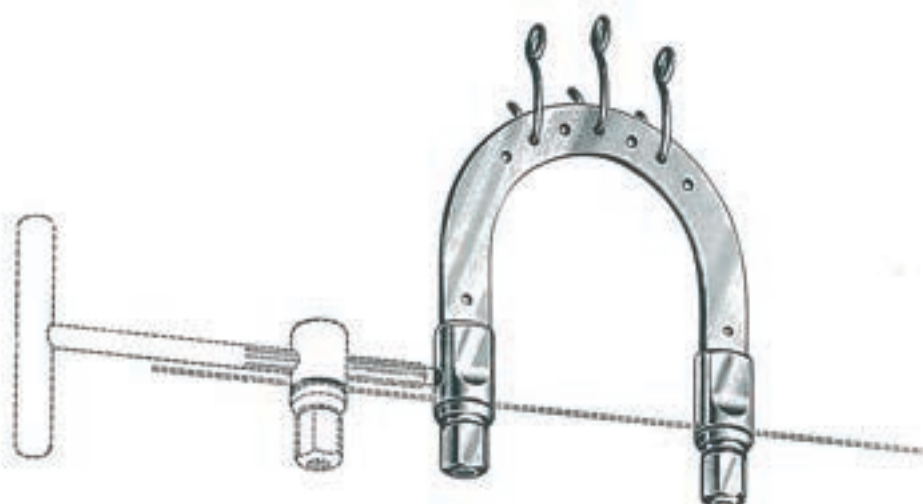

hxb cm	KIRSCHNER
6,0x 5,0	33.512.06
9,5x 7,0	33.512.09
10,5x 10,5	33.512.10
9,5x 11,0	33.512.11
12,0x 12,0	33.512.12
13,5x 13,0	33.512.13
15,5x 15,5	33.512.15
20,0x 15,5	33.512.20



hxb cm	
18x 10	33.514.18
27x 16	33.514.27



33.515.01



33.515.02



KIRSCHNER U.S.
 33.518.01
 Klein · small · petit
 pequeño · piccolo
 33.518.02
 groß · large size
 grand · grande
 33.518.03
 extra groß · extra large size
 extra grand · extra grande



33.519.01



33.519.02

Knochendraht und -Instrumente
Bone Wire and Instruments
Fil à os et instruments
Hilo p. huesos e instrumentos
Filo per ossa e strumenti

33



10 mm

weich
soft
souple
blando
morbido

mm Ø

0,2	33.530.02
0,3	33.530.03
0,4	33.530.04
0,5	33.530.06
0,6	33.530.06
0,7	33.530.07
0,8	33.530.08
0,9	33.530.09
1,0	33.530.10
1,1	33.530.11
1,2	33.530.12
1,5	33.530.15



LOUTE
33.531.21
21 cm



33.532.17
17 cm



Grip
33.533.18
18 cm



33.534.15
15 cm



33.536.14
14 cm

33
Knochenchirurgie
Bone Surgery
Chirurgie osseuse
Cirugia ósea
Chirurgia ossea



33.540.16
16 cm



33.542.15
15 cm



33.545.22
22 cm



mm Ø	
2,4	33.560.24
3,2	33.560.32
4,8	33.560.48
6,4	33.560.64



33.562.24
f./p. Ø 2,4 mm



33.562.32
3,2 mm



33.562.48
4,8 mm



33.562.64
6,4 mm

Knochen Nagelung
Bone Nailing
Enclouage des os
Enclavamiento de huesos
Inchiodamento di ossa



KUENTSCHER
33.571.26
26 cm

KUENTSCHER
33.573.35
35 cm

33.581.35-
33.585.60

mm Ø	L = 35 cm	L = 46 cm	L = 60 cm
2,5	33.581.35	33.581.46	
3,0	33.582.35	33.582.46	
3,5	33.583.35	33.583.46	33.583.60
4,0	33.584.35	33.584.46	33.584.60
5,0	33.585.35	33.585.46	33.585.60



KUENTSCHER
33.586.21
21 cm

KUENTSCHER
33.588.21
21 cm



1/2
33.590.01

1/2
33.590.02



1/2
33.590.03

33.590.04



KUENTSCHER
33.590.00
63 cm



cm	
29	33.596.29
37	33.596.37
42	33.596.42
49	33.596.49



33.598.30

Instrumente zur Osteosynthese
Osteosynthesis Instruments
Instruments p. ostéosynthèse
Instrumentos p. osteosintesis
Strumenti per osteosintesi

33



LANE
33.620.25
25 cm

WILLIAMS
33.624.24
24 cm

mm	
2,5	33.628.25
3,5	33.628.35

LANE
33.632.25
25 cm



LLOYD
33.602.20
20 cm



LANE
33.639.22
22 cm



LANE
33.635.18
18 cm



LANE
33.637.23
23 cm



LANE
33.640.18
18 cm

Instrumentarium zum Einbringen von Hohlschrauben
Instrument Set for Cannulated Screws
Instrumentation pour l'application des vis à perforation longitudinale
Instrumental para la aplicación de tornillos de perforación longitudinal
Strumentario per viti cannulate

Instrumente zur Osteosynthese
Osteosynthesis Instruments
Instruments p. ostéosynthèse
Instrumentos p. osteosíntesis
Strumenti per osteosintesi

33

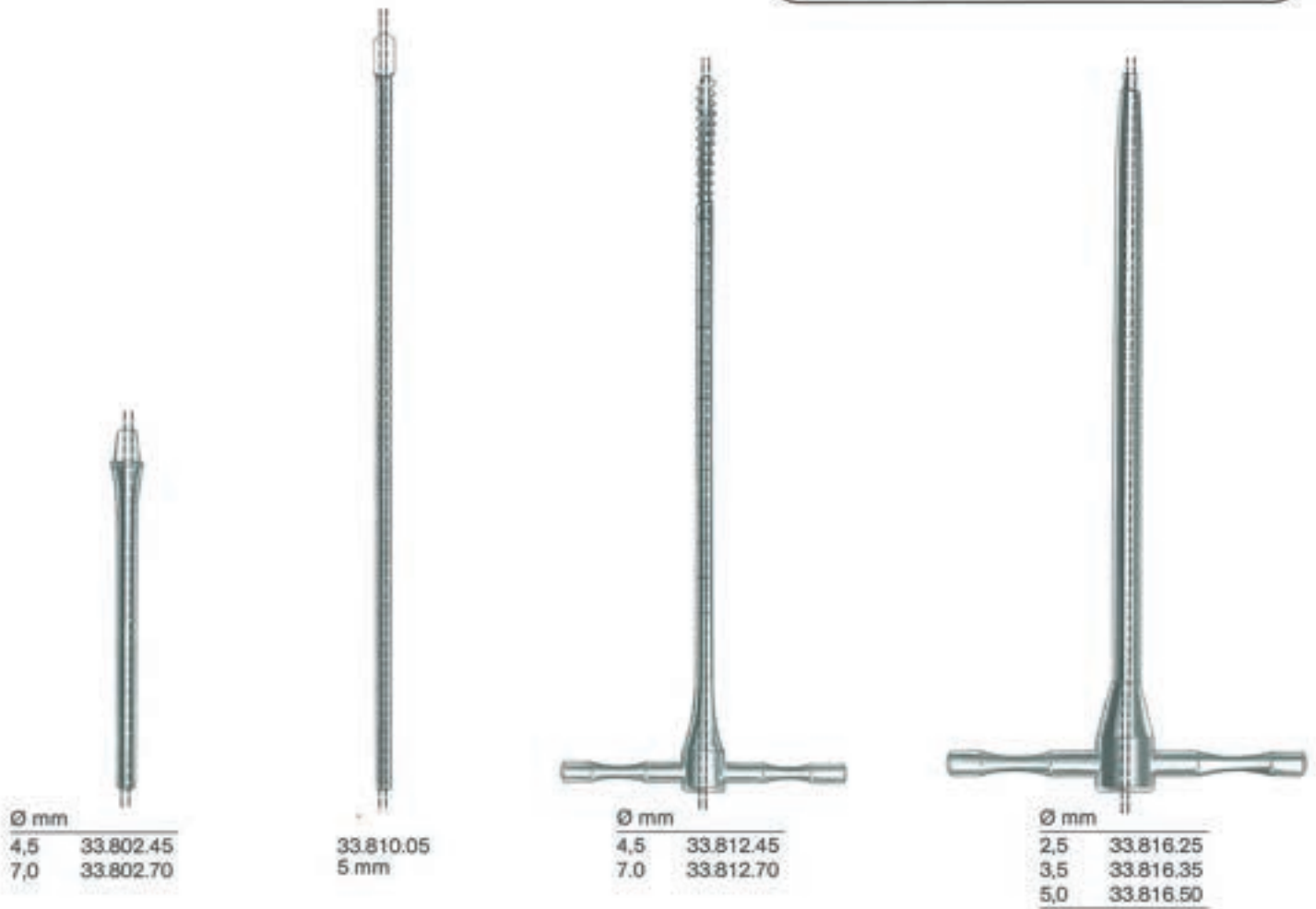

33.820.00

Hohlschrauben siehe S. 152
Cannulated Screws see page 152
Vis à perforation longitudinale, voir p. 152
Tornillos de perforación longitudinal, véanse pag. 152
Viti cannulate, vedere pag. 152

36
Knochenchirurgie
Bone Surgery
Chirurgie osseuse
Cirugía ósea
Chirurgia ossea

Marknägel, rund, mit Haken
Intramedullary Pins, Round, with Hook
Broches à crochets centromédullaires, rondes
Clavos intramedulares con ganchos, redondos
Chiodi a gancio centromidollari, rotondi



Ø mm	Set compl.
2,4	36.002.00
3,2	36.003.00
4,8	36.004.00
6,4	36.006.00

L = mm	Ø 2,4 mm	Ø 3,2 mm	Ø 4,8 mm	Ø 6,4 mm
25	36.002.25			
30	36.002.30			
40	36.002.40			
45	36.002.45			
50	36.002.50			
60	36.002.60			
65	36.002.65			
70	36.002.70			
75	36.002.75			
85	36.002.85			
90	36.002.90			
95	36.002.95			
100	36.002.99	36.003.10		
120		36.003.12		
130		36.003.13		
140		36.003.14		
150		36.003.15		
160		36.003.16		
180		36.003.18		
190		36.003.19		
200		36.003.20	36.004.20	
210		36.003.21		
220			36.004.22	
230		36.003.23		
240		36.003.24	36.004.24	
250		36.003.25		
260			36.004.26	
280			36.004.28	36.006.28
290				36.006.29
300			36.004.30	
320			36.004.32	36.006.32
340			36.004.34	36.006.34
360			36.004.36	36.006.36
370				36.006.37
390				36.006.39
410				36.006.41
430				36.006.43

Knochenchirurgie
Bone Surgery
Chirurgie osseuse
Cirugia ósea
Chirurgia ossea

KÜNTSCHER-Nägel für Oberschenkel
KÜNTSCHER Intramedullary Nails, Femur
KÜNTSCHER clous centromédullaires pour le fémur
KÜNTSCHER clavos centromedulares para el fémur
KÜNTSCHER chiodi centromidollari per il femore



KÜNTSCHER
36.016.14 - 36.026.48

L = cm	Ø 6 mm	Ø 7 mm	Ø 8 mm	Ø 9 mm	Ø 10 mm	Ø 11 mm	Ø 12 mm	Ø 13 mm	Ø 14 mm	Ø 15 mm	Ø 16 mm
14	36.016.14	36.017.14									
16	36.016.16	36.017.16									
18	36.016.18	36.017.18									
20	36.016.20	36.017.20									
22	36.016.22	36.017.22									
24	36.016.24	36.017.24									
26	36.016.26	36.017.26									
28	36.016.28	36.017.28	36.018.28								
30	36.016.30	36.017.30	36.018.30	36.019.30	36.020.30	36.021.30					
32	36.016.32	36.017.32	36.018.32	36.019.32	36.020.32	36.021.32					
34	36.016.34	36.017.34	36.018.34	36.019.34	36.020.34	36.021.34	36.022.34	36.023.34			
35					36.020.35		36.022.35	36.023.35			
36		36.017.36	36.018.36	36.019.36	36.020.36	36.021.36	36.022.36	36.023.36	36.024.36		
37					36.020.37	36.021.37	36.022.37	36.023.37			
38		36.017.38	36.018.38	36.019.38	36.020.38	36.021.38	36.022.38	36.023.38	36.024.38	36.025.38	36.026.38
39					36.020.39	36.021.39	36.022.39	36.023.39	36.024.39		
40		36.017.40	36.018.40	36.019.40	36.020.40	36.021.40	36.022.40	36.023.40	36.024.40	36.025.40	36.026.40
41					36.020.41	36.021.41	36.022.41	36.023.41			
42		36.017.42	36.018.42	36.019.42	36.020.42	36.021.42	36.022.42	36.023.42	36.024.42	36.025.42	36.026.42
43						36.021.43		36.023.43			
44		36.017.44	36.018.44	36.019.44	36.020.44	36.021.44	36.022.44	36.023.44	36.024.44	36.025.44	36.026.44
45											
46		36.017.46	36.018.46	36.019.46	36.020.46	36.021.46	36.022.46	36.023.46	36.024.46	36.025.46	36.026.46
48		36.017.48	36.018.48	36.019.48	36.020.48	36.021.48		36.023.48	36.024.48	36.025.48	36.026.48
50		36.017.50	36.018.50	36.019.50	36.020.50	36.021.50	36.022.50	36.023.50	36.024.50		
52							36.022.52				

36
Knochenchirurgie
Bone Surgery
Chirurgie osseuse
Cirugía ósea
Chirurgia ossea

KÜNTSCHER-Nägels für Unterschenkel und Oberarm
KÜNTSCHER Intramedullary Nails for Tibia and Humerus
KÜNTSCHER clous centromédullaires pour tibia et humérus
KÜNTSCHER clavos centromedulares para tibia y húmero
KÜNTSCHER chiodi centromidollari per tibia e omero



KÜNTSCHER
36.036.18 - 36.044.40

L = cm	Ø 6 mm	Ø 7 mm	Ø 8 mm	Ø 9 mm	Ø 10 mm	Ø 11 mm	Ø 12 mm	Ø 13 mm	Ø 14 mm
18	36.036.18	36.037.18	36.038.18	36.039.18	36.040.18	36.041.18			
19		36.037.19	36.038.19	36.039.19	36.040.19	36.041.19			
20	36.036.20	36.037.20	36.038.20	36.039.20	36.040.20	36.041.20			
21		36.037.21	36.038.21	36.039.21	36.040.21	36.041.21			
22	36.036.22	36.037.22	36.038.22	36.039.22	36.040.22	36.041.22			
23		36.037.23	36.038.23	36.039.23	36.040.23	36.041.23			
24	36.036.24	36.037.24	36.038.24	36.039.24	36.040.24	36.041.24	36.042.24		
25		36.037.25	36.038.25	36.039.25	36.040.25	36.041.25	36.042.25		
26	36.036.26	36.037.26	36.038.26	36.039.26	36.040.26	36.041.26	36.042.26		
27		36.037.27	36.038.27	36.039.27	36.040.27	36.041.27	36.042.27	36.043.27	
28	36.036.28	36.037.28	36.038.28	36.039.28	36.040.28	36.041.28	36.042.28	36.043.28	36.044.28
29		36.037.29	36.038.29	36.039.29	36.040.29	36.041.29	36.042.29	36.043.29	36.044.29
30	36.036.30	36.037.30	36.038.30	36.039.30	36.040.30	36.041.30	36.042.30	36.043.30	36.044.30
31		36.037.31	36.038.31	36.039.31	36.040.31	36.041.31	36.042.31	36.043.31	36.044.31
32		36.037.32	36.038.32	36.039.32	36.040.32	36.041.32	36.042.32	36.043.32	36.044.32
33		36.037.33	36.038.33	36.039.33	36.040.33	36.041.33	36.042.33	36.043.33	36.044.33
34		36.037.34	36.038.34	36.039.34	36.040.34	36.041.34	36.042.34	36.043.34	36.044.34
35		36.037.35	36.038.35	36.039.35	36.040.35	36.041.35	36.042.35	36.043.35	36.044.35
36		36.037.36	36.038.36	36.039.36	36.040.36	36.041.36	36.042.36	36.043.36	36.044.36
37		36.037.37	36.038.37	36.039.37	36.040.37	36.041.37	36.042.37	36.043.37	36.044.37
38		36.037.38	36.038.38	36.039.38	36.040.38	36.041.38	36.042.38	36.043.38	36.044.38
39				36.039.39	36.040.39	36.041.39	36.042.39	36.043.39	36.044.39
40			36.038.40	36.039.40	36.040.40	36.041.40	36.042.40	36.043.40	36.044.40

Knochenchirurgie
Bone Surgery
Chirurgie osseuse
Cirugía ósea
Chirurgia ossea

Schenkelhalsnägel und Zubehör
Hip Nails and Accessories
Clous pour le col du fémur et accessoires
Clavos para el cuello del fémur y accesorios
Chiodi per il collo del femore e accessori

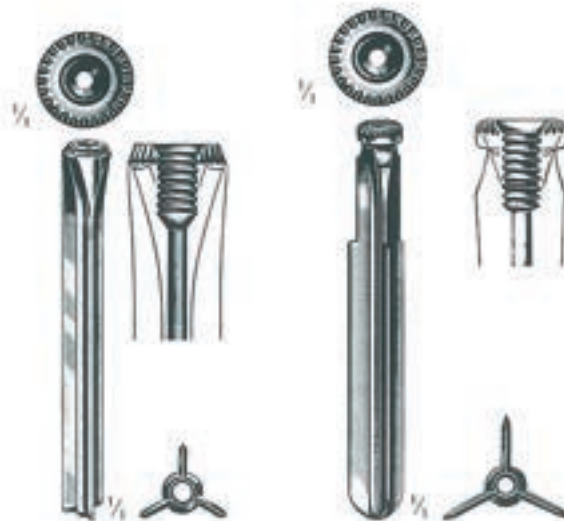

L = mm	SMITH-PETERSEN	BÖHLER
60	36.050.60	
65	36.050.65	
70	36.050.70	
75	36.050.75	
80	36.050.80	36.060.80
85	36.050.85	36.060.85
90	36.050.90	36.060.90
95	36.050.95	36.060.95
100	36.051.00	36.061.00
105	36.051.05	36.061.05
110	36.051.10	36.061.10
115	36.051.15	36.061.15
120	36.051.20	36.061.20
125	36.051.25	
130	36.051.30	36.061.30
135	36.051.35	
140	36.051.40	36.061.40
145	36.051.45	
150	36.051.50	36.061.60
160	36.051.60	
170	36.051.70	



McLAUGHLIN	Loch perf. fori
36.062.03	3
36.062.05	5
36.062.07	7
36.062.12	12



SMITH-PETERSEN	Loch perf. fori
36.063.03	3
36.063.04	4
36.063.05	5
36.063.06	6
36.063.07	7

Knochenchirurgie
Bone Surgery
Chirurgie osseuse
Cirugía ósea
Chirurgia ossea

Schenkelhals-Nägel · Hip Nails
Clous pour le col du fémur ·
Clavos para el cuello del fémur
fracturado · Chiodi per il collo
del femore

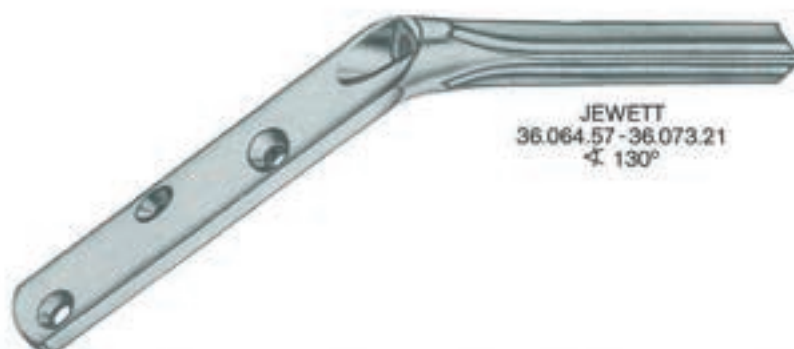

	L = 57 mm	L = 63 mm	L = 70 mm	L = 76 mm	L = 82 mm	L = 89 mm	L = 95 mm	L = 102 mm	L = 108 mm	L = 114 mm	L = 121 mm
A*	36.064.57	36.064.63	36.064.70	36.064.76	36.064.82	36.064.89	36.064.95	36.065.02	36.065.08	36.065.14	36.065.21
B*	36.066.57	36.066.63	36.066.70	36.066.76	36.066.82	36.066.89	36.066.95	36.067.02	36.067.08	36.067.14	36.067.21
C*	36.068.57	36.068.63	36.068.70	36.068.76	36.068.82	36.068.89	36.068.95	36.069.02	36.069.08	36.069.14	36.069.21
D*	36.070.57	36.070.63	36.070.70	36.070.76	36.070.82	36.070.89	36.070.95	36.071.02	36.071.08	36.071.14	36.071.21
E*	36.072.57	36.072.63	36.072.70	36.072.76	36.072.82	36.072.89	36.072.95	36.073.02	36.073.08	36.073.14	36.073.21

*A = 3 Loch, Plattenlänge 90 mm
3 hole, plate length 90 mm
3 trous, longueur de la plaque 90 mm
3 agujeros, largo de la placa 90 mm
3 fori, lunghezza della placca 90 mm

*B = 5 Loch, Plattenlänge 135 mm
5 hole, plate length 135 mm
5 trous, longueur de la plaque 135 mm
5 agujeros, largo de la placa 135 mm
5 fori, lunghezza della placca 135 mm

*C = 7 Loch, Plattenlänge 165 mm
7 hole, plate length 165 mm
7 trous, longueur de la plaque 165 mm
7 agujeros, largo de la placa 165 mm
7 fori, lunghezza della placca 165 mm

*D = 10 Loch, Plattenlänge 220 mm
10 hole, plate length 220 mm
10 trous, longueur de la plaque 220 mm
10 agujeros, largo de la placa 220 mm
10 fori, lunghezza della placca 220 mm

*E = 12 Loch, Plattenlänge 260 mm
12 hole, plate length 260 mm
12 trous, longueur de la plaque 260 mm
12 agujeros, largo de la placa 260 mm
12 fori, lunghezza della placca 260 mm

Knochenchirurgie
Bone Surgery
Chirurgie osseuse
Cirugía ósea
Chirurgia ossea

36

Dynamische Hüft-Schrauben und -Platten ·
Dynamic Hip Screws and Plates · Vis et
plaques dynamiques pour le col du fémur ·
Tornillos y placas dinámicos para el
cuello del fémur · Vite e placche dinamiche
per il collo del femore



36.080.02 - 36.087.12

Rundloch · Round Holes · Trous ronds · Agujeros redondos · Fori rotondi

	2*	4*	5*	6*	8*	10*	12*	14*	16*
135°	36.080.02	36.080.04	36.080.05	36.080.06	36.080.08	36.080.10	36.080.12	36.080.14	36.080.16
140°		36.081.04	36.081.05	36.081.06					
145°		36.082.04	36.082.05	36.082.06					
150°	36.083.02	36.083.04	36.083.05	36.083.06	36.083.08	36.083.10	36.083.12		

Gleitloch · Sliding Holes · Trous à glissement · Agujeros deslizantes · Fori a scivolamento

	2*	4*	5*	6*	8*	10*	12*	14*	16*
135°	36.084.02	36.084.04	36.084.05	36.084.06	36.084.08	36.084.10	36.084.12	36.084.14	36.084.16
140°		36.085.04	36.085.05	36.085.06					
145°		36.086.04	36.086.05	36.086.06					
150°	36.087.02	36.087.04	36.087.05	36.087.06	36.087.08	36.087.10	36.087.12		

* Anzahl Löcher · Number of holes · nombre de trous · número de agujeros · numero di fori



36.088.50 - 36.089.45



36.090.36
36 mm

L = mm	
50	36.088.50
55	36.088.55
60	36.088.60
65	36.088.65
70	36.088.70
75	36.088.75
80	36.088.80
85	36.088.85
90	36.088.90
95	36.088.95
100	36.089.00
105	36.089.05
110	36.089.10
115	36.089.15
120	36.089.20
125	36.089.25
130	36.089.30
135	36.089.35
140	36.089.40
145	36.089.45

Knochenchirurgie
Bone Surgery
Chirurgie osseuse
Cirurgía ósea
Chirurgia ossea

36

Hohlschrauben - Cannulated Screws
Vis à perforation longitudinale
Tornillos de perforación longitudinal
Viti cannulate

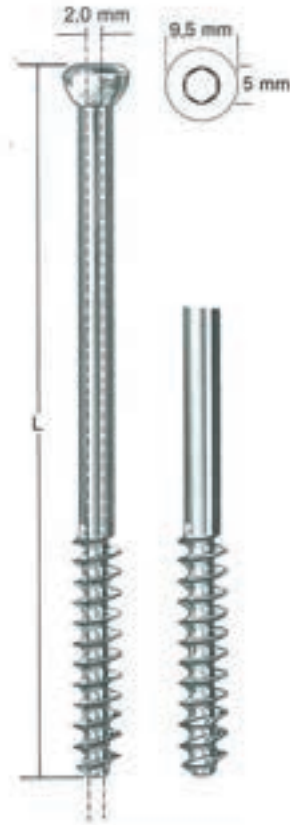
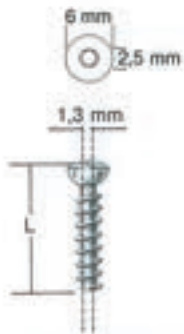

L = mm	Navicular Ø 4,0 mm	Malleolar Ø 4,5 mm	Ø 7 mm, 16 mm *	Ø 7 mm, 32 mm *
10	36.107.10			
12	36.107.12			
14	36.107.14			
16	36.107.16			
18	36.107.18			
20	36.107.20			
22	36.107.22			
24	36.107.24			
25		36.115.25	36.116.25	
26	36.107.26			
28	36.107.28			
30	36.107.30	36.115.30	36.116.30	
35		36.115.35	36.116.35	36.118.35
40		36.115.40	36.116.40	36.118.40
45		36.115.45	36.116.45	36.118.45
50		36.115.50	36.116.50	36.118.50
55		36.115.55	36.116.55	36.118.55
60			36.116.60	36.118.60
65			36.116.65	36.118.65
70			36.116.70	36.118.70
75			36.116.75	36.118.75
80			36.116.80	36.118.80
85			36.116.85	36.118.85
90			36.116.90	36.118.90
95			36.116.95	36.118.95
100			36.117.00	36.119.00
105			36.117.05	36.119.05
110			36.117.10	36.119.10
115			36.117.15	36.119.15
120			36.117.20	36.119.20









36.120.13-36.120.19

Ø mm		Unterlegscheibe
13	36.120.13	Washer
16	36.120.16	Rondelle
19	36.120.19	Arandela
		Rondella

Knochenschrauben ·
Bone Screws · Vis à os ·
Tornillos para huesos ·
Viti per ossa

Osteosynthese
Osteosynthesis
Ostéosynthèse
Osteosintesis
Osteosintesi

		Corticalis			Spongiosa Cancellous		
		mini		klein small petites pequeños piccole		klein small petites pequeños piccole	
							
		3 mm	4 mm	5 mm	6 mm	6 mm	6 mm
		1.5 mm	2.0 mm	2.5 mm	2.5 mm	2.5 mm	2.5 mm
L = mm			DIN 58812 ISO 5835/1	DIN 58812 ISO 5835/1	DIN 58812 ISO 5835/1		DIN 58815 ISO 5835/1
6	36.200.06	36.201.06	36.202.06				
7	36.200.07						
8	36.200.08	36.201.08	36.202.08				
9	36.200.09						
10	36.200.10	36.201.10	36.202.10	36.204.10	36.206.10	36.207.10	
11	36.200.11						
12	36.200.12	36.201.12	36.202.12	36.204.12	36.206.12	36.207.12	
14	36.200.14	36.201.14	36.202.14	36.204.14	36.206.14	36.207.14	
16	36.200.16	36.201.16	36.202.16	36.204.16	36.206.16	36.207.16	
18		36.201.18	36.202.18	36.204.18	36.206.18	36.207.18	
20		36.201.20	36.202.20	36.204.20	36.206.20	36.207.20	
22			36.202.22	36.204.22	36.206.22	36.207.22	
24			36.202.24	36.204.24	36.206.24	36.207.24	
26			36.202.26	36.204.26	36.206.26	36.207.26	
28			36.202.28	36.204.28	36.206.28	36.207.28	
30						36.207.30	
32			36.202.32	36.204.32	36.206.32		
35						36.207.35	
36				36.204.36	36.206.36		
40				36.204.40	36.206.40	36.207.40	
45				36.204.45	36.206.45	36.207.45	
50				36.204.50	36.206.50	36.207.50	
55					36.206.55		
60					36.206.60		

Unterlegscheibe
Washer
Rondelle
Arandela
Rondella



7 mm
36.209.97

Osteosynthese
Osteosynthesis
Ostéosynthèse
Osteosintesis
Osteosintesi

Große Schrauben
Large Screws
Vis grandes
Tornillos grandes
Viti grandi

Corticalis- und Malleolarschrauben
Corticalis and Malleolar Screws
Vis corticales et malléolaires
Tornillos corticales y maleolares
Viti corticali e malleolari



L = mm	DIN 58812 ISO 5835/1	DIN 58814 ISO 5835/1
14	36.214.14	
16	36.214.16	
18	36.214.18	
20	36.214.20	
22	36.214.22	
24	36.214.24	
25		36.215.25
26	36.214.26	
28	36.214.28	
30	36.214.30	36.215.30
32	36.214.32	
34	36.214.34	
35		36.215.35
38	36.214.38	
38	36.214.38	
40	36.214.40	36.215.40
42	36.214.42	
44	36.214.44	
45		36.215.45
46	36.214.46	
48	36.214.48	
50		36.215.50
52	36.214.52	
54		
55		36.215.55
56	36.214.56	
60	36.214.60	36.215.60
64	36.214.64	
65		36.215.65
70	36.214.70	36.215.70

Mutter
Nut
Ecrou
Tuerca
Dado



36.219.96

Große Schrauben
Large Screws
Vis grandes
Tornillos grandes
Viti grandi

Osteosynthese
Osteosynthesis
Ostéosynthèse
Osteosíntesis
Osteosintesi

36

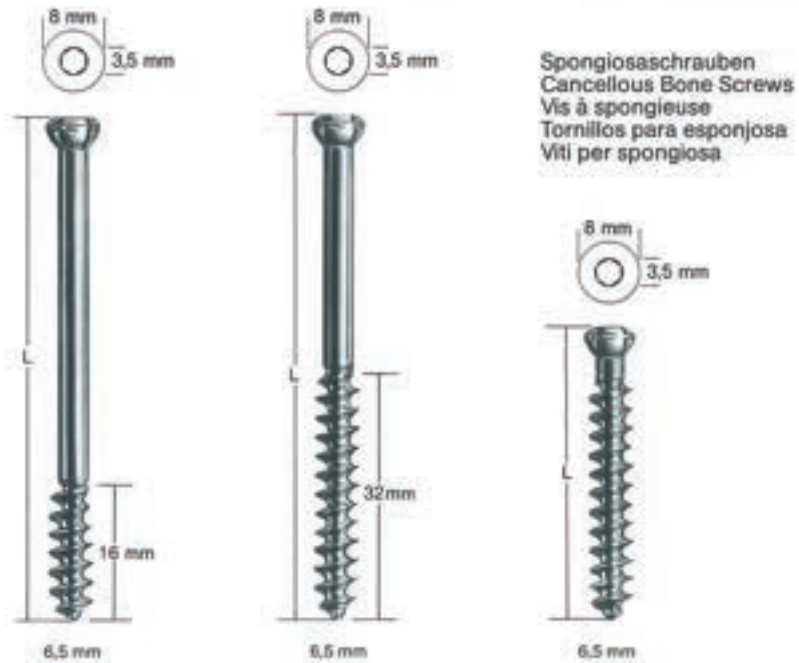

L = mm	DIN 58815 ISO 5835/1	DIN 58815 ISO 5835/1	
25			36.218.25
30	36.216.30		36.218.30
35	36.216.35		36.218.35
40	36.216.40		36.218.40
45	36.216.45	36.217.45	36.218.45
50	36.216.50	36.217.50	36.218.50
55	36.216.55	36.217.55	36.218.55
60	36.216.60	36.217.60	36.218.60
65	36.216.65	36.217.65	36.218.65
70	36.216.70	36.217.70	36.218.70
75	36.216.75	36.217.75	36.218.75
80	36.216.80	36.217.80	36.218.80
85	36.216.85	36.217.85	36.218.85
90	36.216.90	36.217.90	36.218.90
95	36.216.95	36.217.95	36.218.95
100	36.216.00	36.217.00	36.218.00
105	36.216.05	36.217.05	36.218.05
110	36.216.10	36.217.10	36.218.10

Unterlegscheibe
Washer
Rondelle
Arandela
Rondella



36

Osteosynthese
Osteosynthesis
Ostéosynthèse
Osteosintesis
Osteosintesi

Halbrohrplatten mit Rundlöchern
Semi-tubular Plates with Round Holes
Plaques semi-tubulaires à trous ronds
Placas semitubulares con orificios redondos
Placche semitubolari con fori rotondi



36.222.02 - 36.222.12

L = mm	Löcher - Holes - Trous Orificios - Fori	
39	2	36.222.02
55	3	36.222.03
71	4	36.222.04
87	5	36.222.05
103	6	36.222.06
119	7	36.222.07
135	8	36.222.08
151	9	36.222.09
167	10	36.222.10
183	11	36.222.11
199	12	36.222.12

Osteosynthese
Osteosynthesis
Ostéosynthèse
Osteosíntesis
Osteosintesi

Schmale Platten
Narrow Plates
Plaques étroites
Placas estrechas
Placche strette



36.223.02 - 36.223.16

Rundloch
Round Holes
Trous ronds
Orificios redondos
Fori rotondi



36.224.02 - 36.224.16

Gleitloch
Gliding Holes
Trous à compression
Orificios para compresión
Fori da compressione

L = mm	Löcher · Holes · Trous Orificios · Fori	Rundloch · Round Holes · Trous ronds · Orificios redondos · Fori rot.	Gleitloch · Gliding Holes · Trous à compres. Orificios p. compres. · Fori da compress.
39	2	36.223.02	36.224.02
55	3	36.223.03	36.224.03
71	4	36.223.04	36.224.04
87	5	36.223.05	36.224.05
103	6	36.223.06	36.224.06
119	7	36.223.07	36.224.07
135	8	36.223.08	36.224.08
151	9	36.223.09	36.224.09
167	10	36.223.10	36.224.10
183	11	36.223.11	36.224.11
199	12	36.223.12	36.224.12
215	13	36.223.13	36.224.13
231	14	36.223.14	36.224.14
247	15	36.223.15	36.224.15
263	16	36.223.16	36.224.16

36

Osteosynthese
Osteosynthesis
Ostéosynthèse
Osteosintesis
Osteosintesi

Breite Platten
Broad Plates
Plaques larges
Placas anchas
Placche larghe



36.225.06 - 36.225.18

Rundloch
Round Holes
Trous ronds
Orificios redondos
Fori rotondi



36.226.06 - 36.226.18

Gleitloch
Gliding Holes
Trous à compression
Orificios p. compresión
Fori da compressione

L = mm	Lücher - Holes - Trous Orificios - Fori	Rundloch - Round Holes - Trous ronds Orificios redondos - Fori rotondi	Gleitloch - Gliding Holes - Trous à compression Orificios para compr. - Fori da compressione
103	6	36.225.06	36.226.06
119	7	36.225.07	36.226.07
135	8	36.225.08	36.226.08
151	9	36.225.09	36.226.09
167	10	36.225.10	36.226.10
199	12	36.225.12	36.226.12
231	14	36.225.14	36.226.14
263	16	36.225.16	36.226.16
295	18	36.225.18	36.226.18

Kondylenplatten
Condylar Plates
Plaques condyloires
Placas condilares
Placche condilari

Osteosynthese
Osteosynthesis
Ostéosynthèse
Osteosintesis
Osteosintesi

36



36.231.20 - 36.231.26
36.237.20 - 36.237.26

36.231.50 - 36.231.56
36.237.50 - 36.237.56

36.231.70 - 36.231.76
36.237.70 - 36.237.76

36.231.90 - 36.231.96
36.237.90 - 36.237.96

Rundlöcher · Round Holes · Trous ronds · Orificios redondos · Fori rotondi

KL \ SL	92 mm	124 mm	156 mm	204 mm
50 mm	36.231.20	36.231.50	36.231.70	36.231.90
60 mm	36.231.22	36.231.52	36.231.72	36.231.92
70 mm	36.231.24	36.231.54	36.231.74	36.231.94
80 mm	36.231.26	36.231.56	36.231.76	36.231.96

Gleitlöcher · Gliding Holes · Trous à compression · Orificios para compresión · Fori da compressione

KL \ SL	92 mm	124 mm	156 mm	204 mm
50 mm	36.237.20	36.237.50	36.237.70	36.237.90
60 mm	36.237.22	36.237.52	36.237.72	36.237.92
70 mm	36.237.24	36.237.54	36.237.74	36.237.94
80 mm	36.237.26	36.237.56	36.237.76	36.237.96

Osteosynthese
Osteosynthesis
Ostéosynthèse
Osteosíntesis
Osteosintesi

Winkelplatten
Angular Plates
Plaques angulaires
Placas angulares
Placche angolari



∠ 130°

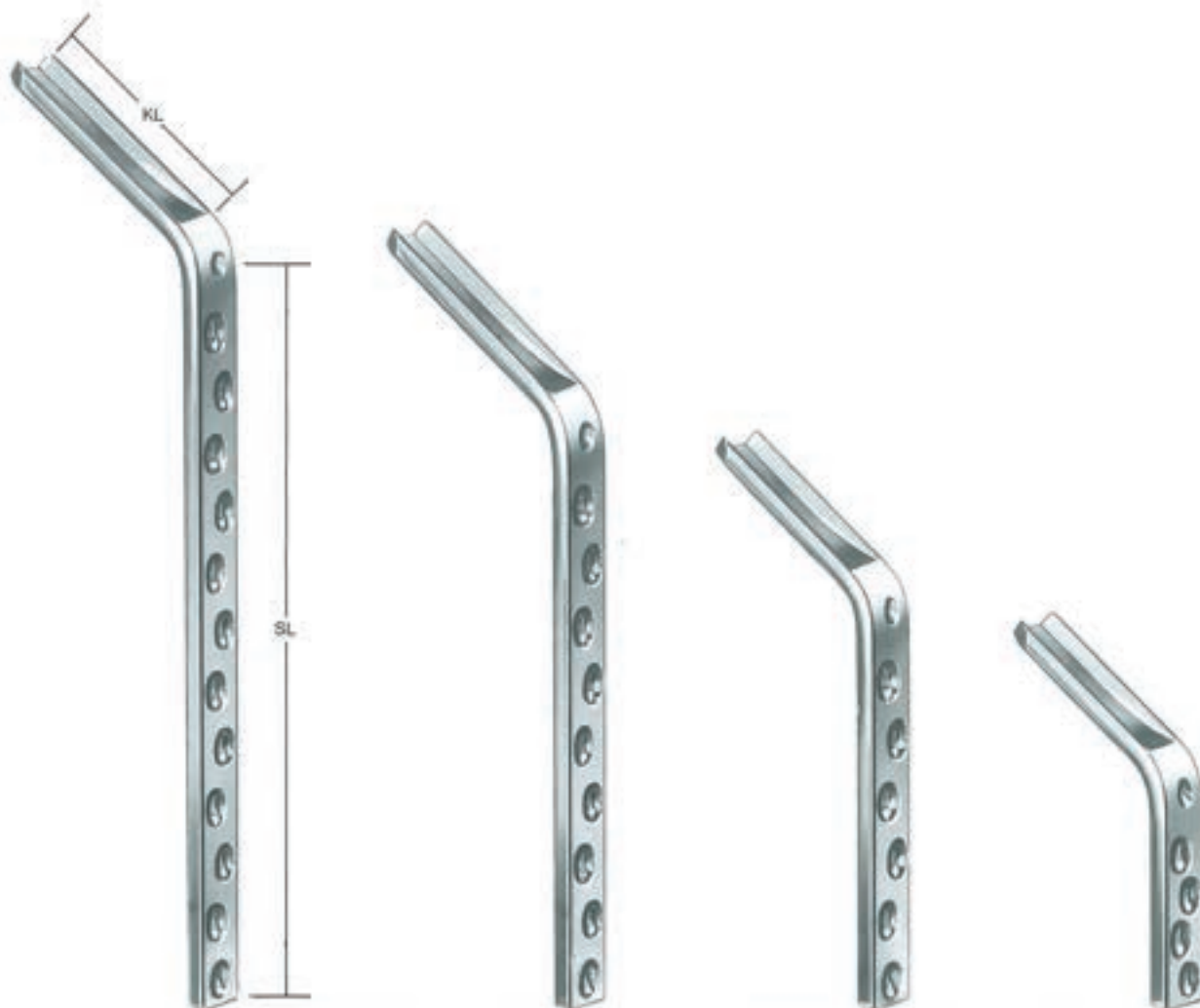

KL \ SL	Rundloch · Round Holes · Troux ronds · Orificios redondos · Fori rotondi				Gleitlöcher · Gliding Holes · Troux à compression · Orificios para compresión · Fori da compressione			
	60 mm	104 mm	152 mm	200 mm	60 mm	104 mm	152 mm	200 mm
50 mm	36.233.36	36.233.60			36.238.36	36.238.60		
60 mm	36.233.38	36.233.62			36.238.38	36.238.62		
70 mm	36.233.44	36.233.64	36.233.94	36.233.24	36.238.44	36.238.64	36.238.94	36.238.24
75 mm	36.233.45				36.238.45			
80 mm	36.233.46	36.233.66	36.233.96	36.233.26	36.238.46	36.238.66	36.238.96	36.238.26
85 mm	26.233.47				36.238.47			
90 mm	36.233.48	36.233.68	36.233.98	36.233.28	36.238.48	36.238.68	36.238.98	36.238.28
95 mm	36.233.49				36.238.49			
100 mm	36.233.40				36.238.40			
105 mm	36.233.41				36.238.41			
110 mm	36.233.42				36.238.42			

Osteosynthese
Osteosynthesis
Ostéosynthèse
Osteosintesis
Osteosintesi

Knochenplatten mit Rundlöchern
Bone plates with Round Holes
Plaques à os à trous ronds
Placas p. huesos con orificios redondos
Placche per ossa con fori rotondi

Drittelrohrplatten
One Third-Tubular Plates
Plaques d'un tiers de tube
Placas de un tercio de tubo
Placche di un terzo di tubo

Verteilorhrplatten
One Quarter-Tubular Plates
Plaques d'un quart de tube
Placas de un cuarto de tubo
Placche di un quarto di tubo



36.241.02 - 36.241.08

L = mm	Loch · Holes Trous · Ori- ficios · Fori	
25	2	36.241.02
37	3	36.241.03
49	4	36.241.04
61	5	36.241.05
73	6	36.241.06
85	7	36.241.07
97	8	36.241.08



36.242.13 - 36.242.18

L = mm	Loch · Holes Trous · Ori- ficios · Fori	
23	3	36.242.13
31	4	36.242.14
39	5	36.242.15
47	6	36.242.16
55	7	36.242.17
63	8	36.242.18

Osteosynthese
Osteosynthesis
Ostéosynthèse
Osteosintesis
Osteosintesi

Mini-Fragment-Platten
Mini Fragment Plates
Plaques à fragments mini
Placas para fragmentos mini
Placche per frammenti mini

Finger-Platten
Finger Plates
Plaques à doigts
Placas para dedos
Placche per dita

L-förmig, links
L-shaped, left side
forme L, à gauche
forma L, a la izquierda
forma L, a sinistra



36.242.31 36.242.32

L-förmig, rechts
L-shaped, right side
forme L, à droite
forma L, a la derecha
forma L, a destra

schräg links
left side oblique
à gauche oblique
a la izquierda oblicua
a sinistra obliqua



36.242.33 36.242.34

schräg rechts
right side oblique
à droite oblique
a la derecha oblicua
a destra obliqua

T-förmig
T-shaped
forme T
forma T
forma T



36.242.41

Gerade Mini-Platten
Straight Mini Plates
Mini-plaques droites
Mini-placas rectas
Mini-placche rette



36.243.13-36.243.16

L = mm	Löcher - Holes - Trous Orificios - Fori	
17	3	36.243.13
23	4	36.243.14
29	5	36.243.15
35	6	36.243.16

Osteosynthese
Osteosynthesis
Ostéosynthèse
Osteosintesis
Osteosintesi

Finger-Platten
Finger Plates
Plaques à doigts
Placas para dedos
Placche per dita

L-förmig, links
L-shaped, left side
forme L, à gauche
forma L, a la izquierda
forma L, a sinistra



36.243.31 36.243.32

L-förmig, rechts
L-shaped, right side
forme L, à droite
forma L, a la derecha
forma L, a destra

schräg links
left side oblique
à gauche oblique
a la izquierda oblicua
a sinistra obliqua



36.243.33 36.243.34

schräg rechts
right side oblique
à droite oblique
a la derecha oblicua
a destra obliqua

T-förmig
T-shaped
forme T
forma T
forma T



36.243.41



36.244.02 - 36.244.22

Kleinfragmentplatten
Small Fragment Plates
Plaques pour petits fragments
Placas para fragmentos pequeños
Placche per piccoli fragmenti



36.248.02 - 36.248.12

L = mm	Löcher - Holes - Troux Orificios - Fori	
20	2	36.244.02
36	4	36.244.04
44	5	36.244.05
52	6	36.244.06
60	7	36.244.07
68	8	36.244.08
76	9	36.244.09
84	10	36.244.10
100	12	36.244.12
26	2	36.244.22

L = mm	Löcher - Holes - Troux Orificios - Fori	
25	2	36.248.02
37	3	36.248.03
49	4	36.248.04
61	5	36.248.05
73	6	36.248.06
85	7	36.248.07
97	8	36.248.08
121	10	36.248.10
145	12	36.248.12

36

Osteosynthese
Osteosynthesis
Ostéosynthèse
Osteosintesis
Osteosintesi

SHERMAN Knochenplatten und -schrauben
SHERMAN Bone Plates and Bone Screws
SHERMAN plaques et vis à os
SHERMAN placas y tornillos para huesos
SHERMAN placche e viti per ossa

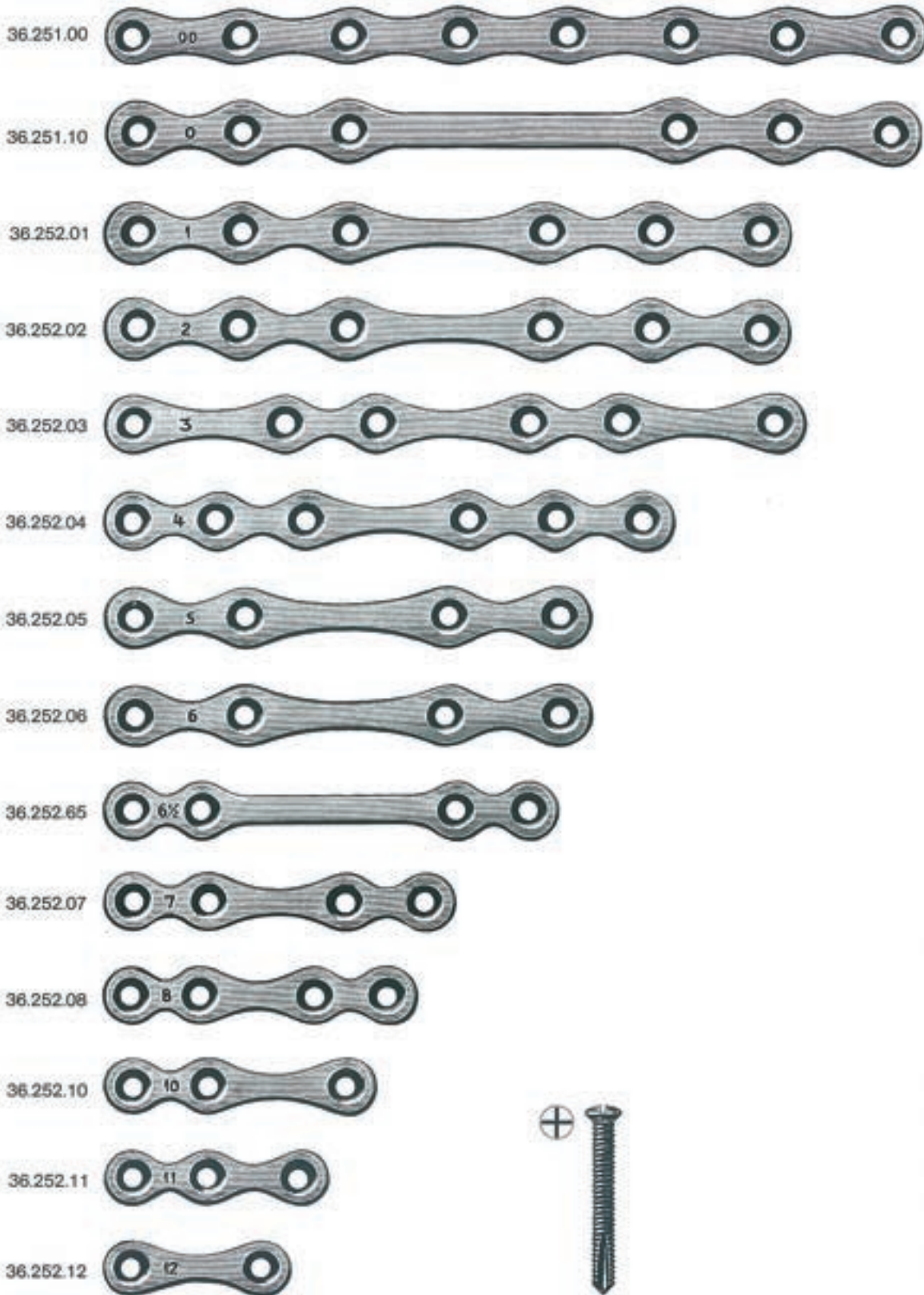

SHERMAN
36.251.00 - 36.252.12

SHERMAN
36.256.10 - 36.256.99
4 mm Ø

L = mm	
10	36.256.10
13	36.256.13
16	36.256.16
19	36.256.19
22	36.256.22
25	36.256.25
29	36.256.29
32	36.256.32
35	36.256.35
38	36.256.38
41	36.256.41
45	36.256.45
50	36.256.50
57	36.256.57
63	36.256.63
75	36.256.75
89	36.256.89
99	36.256.99

Osteosynthese
Osteosynthesis
Ostéosynthèse
Osteosintesis
Osteosintesi

36

Weitere Implantate für die Osteosynthese in Vorbereitung.
Verlangen Sie unseren Spezialkatalog.

Further implants for osteosynthesis are in preparation.
Please ask for our special catalogue.

D'autres implants pour l'ostéosynthèse sont en préparation.
Demandez notre catalogue spécial, s.v.p.

Otros implantes para la osteosintesis en preparaci3n.
Pidan nuestro cat3logo especial, por favor.

Ulteriori impianti per la osteosintesi sono in preparazione.
Chiedete il ns. catalogo speciale, per favore.

Hirnaht
Brain Suture
Suture cérébrale
Sutura cerebral
Sutura cerebrale

40

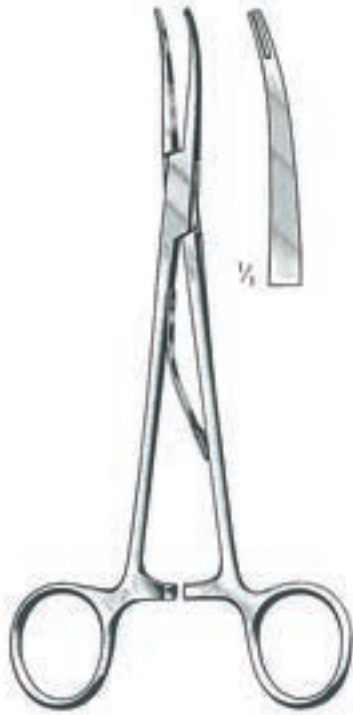

cm	McKENZIE
15	40.011.15
19	40.011.19

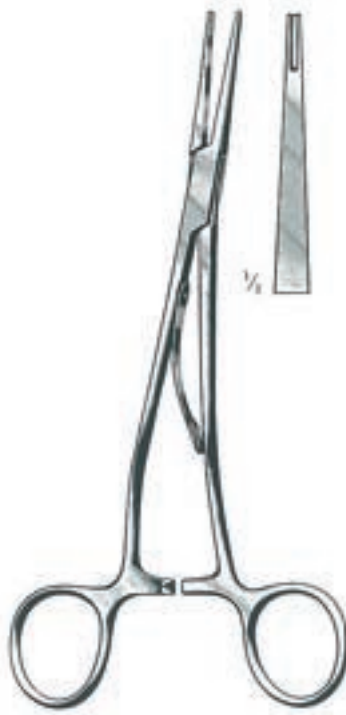

cm	McKENZIE
15	40.013.15
19	40.013.19

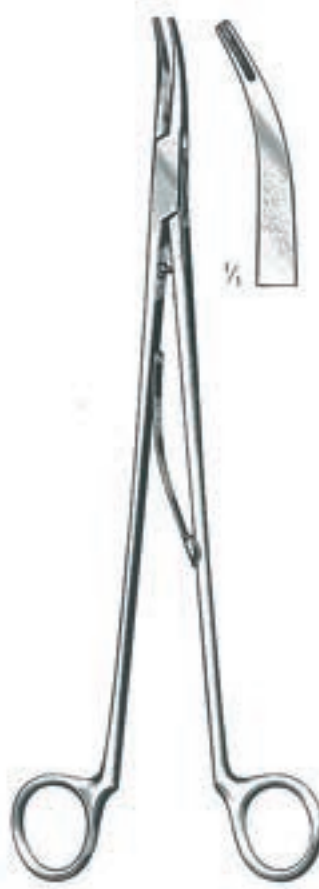

cm	SMITHWICK
23	40.015.23
26	40.015.26

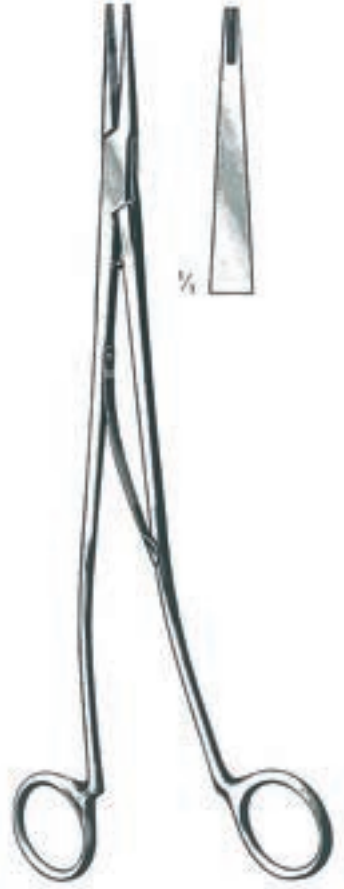

cm	SWEET
23	40.017.23
26	40.017.26



OLIVECRONA-TOENNIS
40.019.14



40.021.00



40.020.00
148x40x6 mm

Schädelhalter
Cervical Traction Tongs
Pincès de traction crânienne
Pinzas de tracción cranial
Pinze per trazione craniale

40

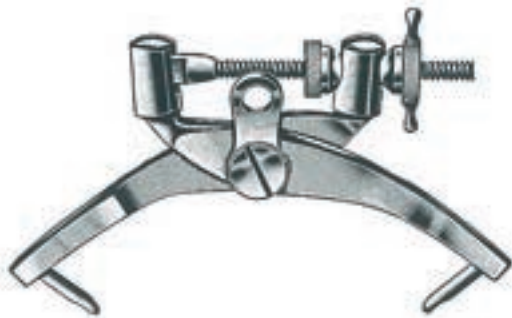

CRUTCHFIELD
40.025.01



CRUTCHFIELD
40.025.02



40.026.35
3,5 mm Ø



40.026.50
5 mm Ø

Kopfhautklammer, -anlegezange
Scalp Hemostasis Clip, Applying Forceps
Pince hémostatique pour le cuir chevelu, pince à poser
Pinza hemostática para cuero cabelludo, pinza para poner
Pinza emostatica per il cuolo capelluto, pinza per applicare e togliere



RANEY
40.027.00



RANEY
40.028.00

Nervhaken
Nerve Retractors
Ecarteurs à nerfs
Separadores para nervios
Divaricatori per nervi

40



DANDY
40.051.20
20 cm

DANDY
40.052.20
20 cm

DANDY
40.053.20
20 cm



CUSHING
40.056.28
28 cm



CUSHING
40.058.28
28 cm



GRAHAM
40.061.16
16,5 cm



SACHS
40.064.18
18,5 cm



ADSON
40.068.20
20 cm

ADSON
40.069.20
20 cm



SMITHWICK
40.070.29
29 cm

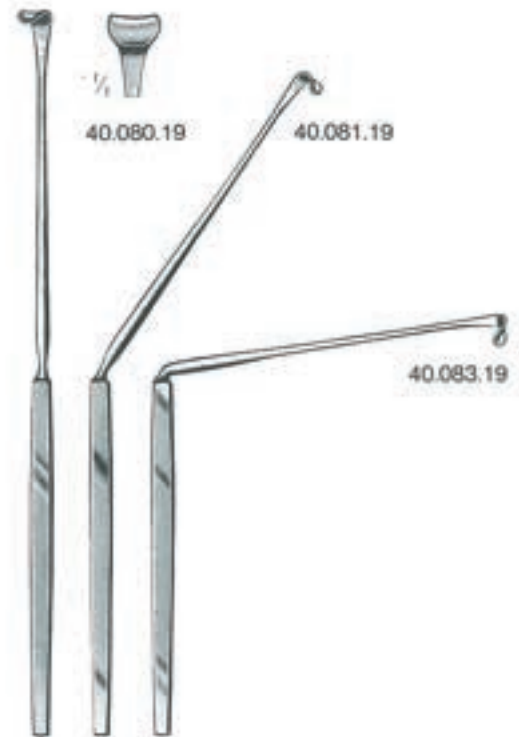

LOVE
40.080.19-40.083.19

Neurochirurgie
Neurosurgery
Neurochirurgie
Neurocirugia
Neurochirurgia



De MARTEL
40.090.33
33 cm



De VILBISS
40.096.21
21 cm



cm	OLIVECRONA
30	40.092.30
40	40.092.40
50	40.092.50
60	40.092.60
70	40.092.70



GIGLI
40.094.00

Dura-Dissektoren · Dura Dissectors · Dissecteurs à duremère
Descoladores para la duramadre · Scollatori per la duramadre



TOENNIS
40.141.25
25 cm



SACHS
40.143.21



SACHS
40.145.21



MILLIGAN
40.147.21



40.149.22



DAVIS
40.151.24

Neurochirurgie
Neurosurgery
Neurochirurgie
Neurocirurgia
Neurochirurgia

40

Dura-Dissektoren, -Messer
Dura Dissectors, Knife
Dissecteurs, bistouri à duremère
Descoladores, bisturi para duramadre
Scollatori, bisturi per duramadre



HORSLEY
40.155.20
20 cm



PENFIELD
40.161.01
17,5 cm



PENFIELD
40.161.02
19,5 cm



PENFIELD
40.161.03
19,5 cm



HALLE
40.170.20

Hypophysenpinzetten · Hypophyseal Forceps · Pincas à hypophyse · Pinzas para hipófisis · Pinze per ipofisi



ADSON
40.210.23



ADSON
40.211.23



ADSON
40.213.23

Hirnspatel, Saugrohre
Brain Spatulas, Aspir. Tubes
Spatules cérébr., tubes d'aspir.
Espátulas cerebr., tubos de aspir.
Spatole cerebr., tubi per aspiraz.



mm CUSHING
7/ 9 40.250.07
11/13 40.250.11
15/18 40.250.15
18/22 40.250.18
180 mm



mm OLIVECRONA
7/ 9 40.253.07
11/13 40.253.11
15/18 40.253.15
18/22 40.253.18
180 mm



mm HEIFETZ
8 40.260.08
11 40.260.11
14 40.260.14
17 40.260.17



ADSON
40.290.21
21 cm/4 mm

Cherr. F.G.	30°	75°
6	40.295.06	40.297.06
7	40.295.07	40.297.07
8	40.295.08	40.297.08
9	40.295.09	40.297.09
10	40.295.10	40.297.10
11	40.295.11	40.297.11
12	40.295.12	40.297.12
15	40.295.15	40.297.15



FRAZIER
40.295.06-40.297.12
19 cm

Wirbelkörperspreizer - Lamina Spreaders -
Ecarteurs pour corps vertébraux -
Separadores para cuerpos vertebrales -
Divaricatori per corpi vertebrali



FRAZIER
40.298.12
12 cm/3 mm



CLOWARD
40.401.16



INGE
40.405.17 - 40.405.27

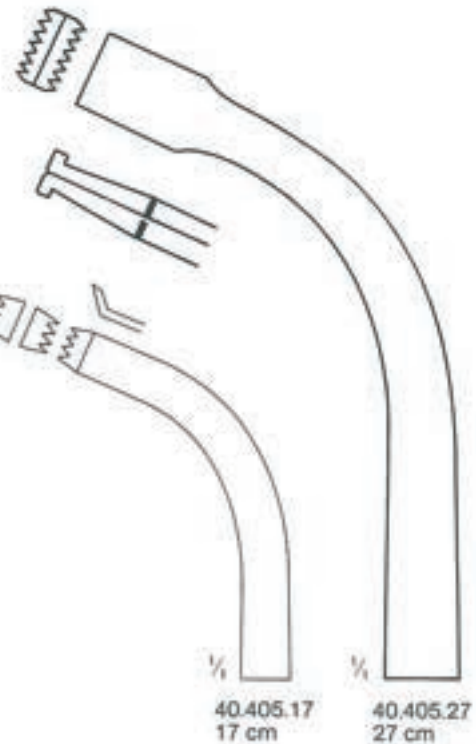

40.405.17
17 cm

40.405.27
27 cm

40
Laminektomie
Laminectomy
Laminectomie
Laminectomia
Laminectomia

Laminektomie-Zangen
Laminectomy Rongeurs
Pincas emporte-pièce à laminectomie
Pinzas cortantes para laminectomia
Pinze taglianti per laminectomia



CUSHING
2 mm



2x 10 mm	L
40.420.01	12,5 cm
40.422.01	18,0 cm



2x 10 mm / 45°	L
40.420.02	12,5 cm
40.422.02	18,0 cm



2x 10 mm / 45°	L
40.420.03	12,5 cm
40.422.03	18,0 cm

LOVE-GRUENWALD
3 mm



3x 10 mm	L
40.430.01	12,5 cm
40.432.01	18,0 cm



3x 10 mm / 45°	L
40.430.02	12,5 cm
40.432.02	18,0 cm



3x 10 mm / 45°	L
40.430.03	12,5 cm
40.432.03	18,0 cm

SPURLING
4 mm



4x 10mm	L
40.440.01	12,5 cm
40.442.01	18,0 cm



4x 10mm / 45°	L
40.440.02	12,5 cm
40.442.02	18,0 cm



4x 10mm / 45°	L
40.440.03	12,5 cm
40.442.03	18,0 cm

Laminektomie-Zangen
Laminectomy Rongeurs
Pinces emporte-pièce à laminectomie
Pinzas cortantes para laminectomia
Pinze taglianti per laminectomia

Laminektomie
Laminectomy
Laminectomie
Laminectomia
Laminectomia

40

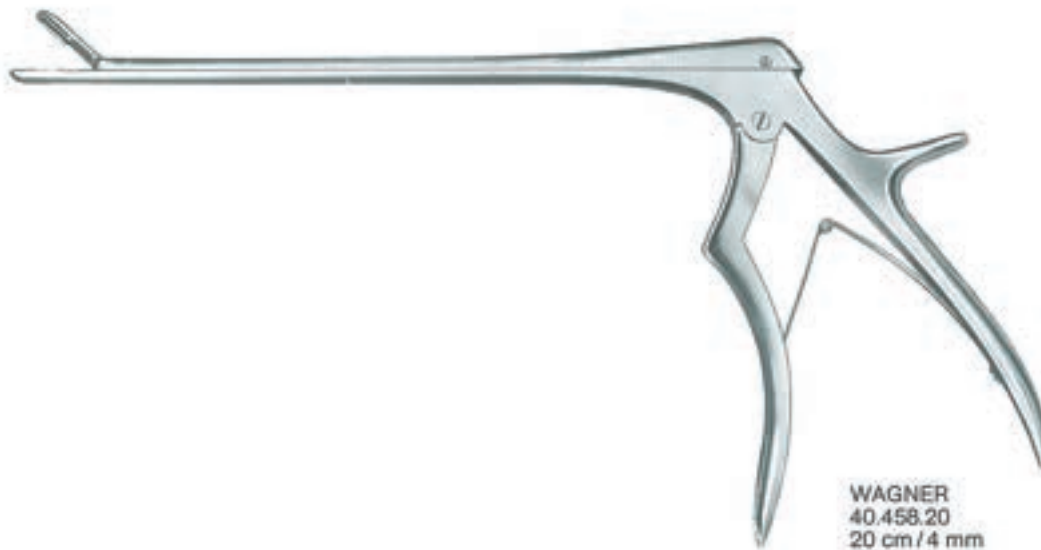
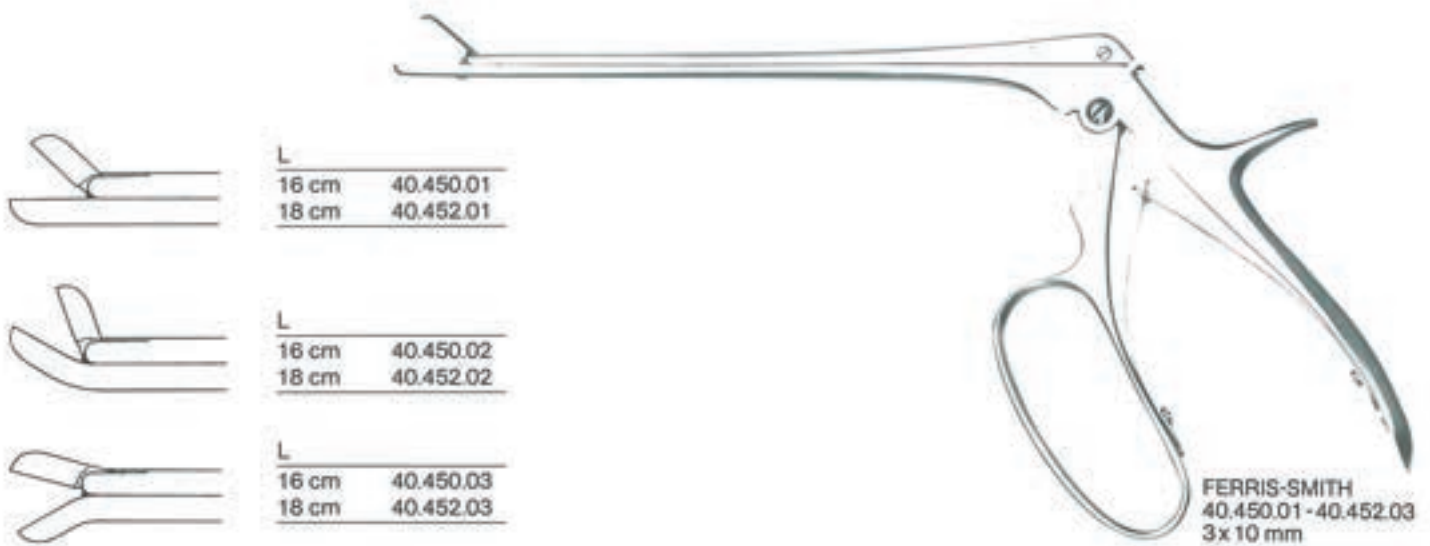
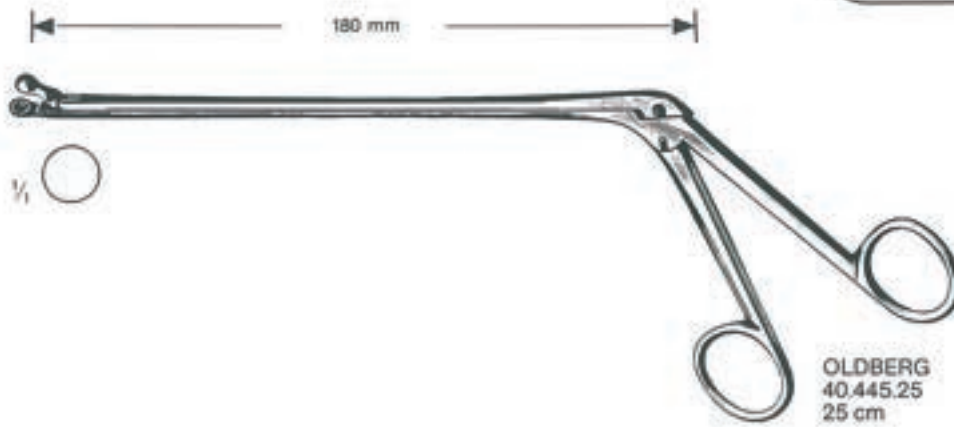

40
Laminektomie
Laminectomy
Laminectomie
Laminectomía
Laminectomia

Bandscheiben-Stanzen
Intervertebral Disc Rongeurs
Pinces emporte-pièce pour lames intervertébrales
Pinzas sacabocado para discos intervertebrales
Pinze taglienti per dischi intervertebrali



FERRIS-SMITH-KERRISON
40.510.01-40.512.05
18 cm



40.510.01
1 mm



40.511.01
1 mm



40.510.02
2 mm



40.511.02
2 mm



40.512.02
2 mm



40.510.03
3 mm

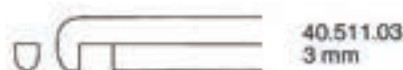

40.511.03
3 mm

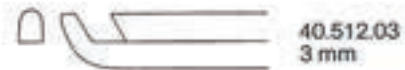

40.512.03
3 mm



40.510.04
4 mm



40.511.04
4 mm



40.510.05
5 mm



40.511.05
5 mm



40.512.05
5 mm

Bandscheiben-Stanzen
Intervertebral Disc Rongeurs
Pincas emporte-pièce pour lames intervertébrales
Pinzas sacabocado para discos intervertebrales
Pinze taglianti per dischi intervertebrali

Laminectomie
Laminectomy
Laminectomie
Laminectomia
Laminectomia

40



COLCLOUGH
40.520.03-40.525.05

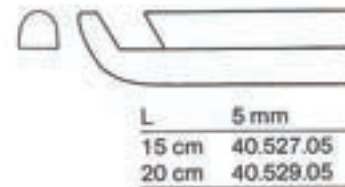
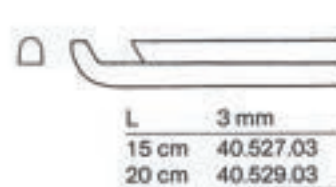
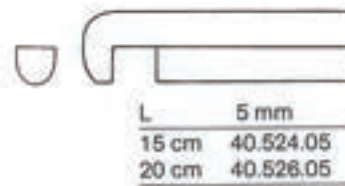
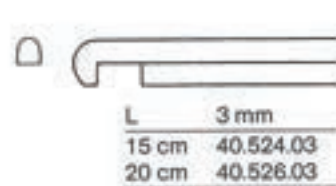
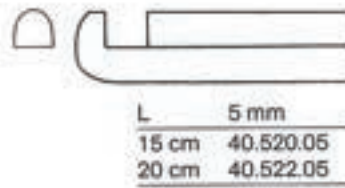
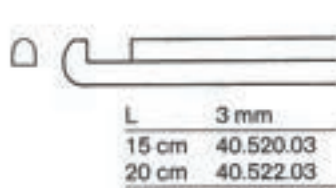

40
 Neuro-, Gefäßchirurgie
 Neuro, Vascular Surgery
 Neurochir., Chir. vascul.
 Neurocir., Cir. vascular
 Neurochir., Chir. vascolare

Temporäre Clips = vergoldete Federenden
 Temporary Clips = gold plated spring ends
 Clips temporaires = bouts des ressorts dorés
 Clips temporarios = extremos de los resortes dorados
 Clips temporari = estremo della molla dorato

Clips „Mini“

MINI 	permanent				temporary					
		Maulöffnung Opening Ouverture Abertura Apertura	Maullänge Length of Jaws Longueur des mors Largo de la boca Lunghezza dei morsi	Schließkraft Closing Force Force de fermeture Fuerza de compresión Forza di compressione		Maulöffnung Opening Ouverture Abertura Apertura	Maullänge Length of Jaws Longueur des mors Largo de la boca Lunghezza dei morsi	Schließkraft Closing Force Force de fermeture Fuerza de compresión Forza di compressione		
	40.570.30	3,0 mm	3 mm	100-130 g (0,98-1,28 N)	40.571.30	3,0 mm	3 mm	35-45 g (0,34-0,44 N)		
	40.572.30	3,0 mm	3 mm							
	40.580.35	3,5 mm	5 mm		40.581.35	3,5 mm	5 mm			
	40.582.35	3,5 mm	5 mm		40.583.35	3,5 mm	5 mm			
	40.584.33	3,3 mm	5 mm							
	40.690.30	3,0 mm	3 mm							
	40.692.35	3,5 mm	5 mm							
	40.694.35	3,5 mm	5 mm							
	40.696.33	3,3 mm	5 mm							
	40.698.30	3,0 mm	5 mm							
	40.710.40	4,0 mm	7 mm			40.711.40	4,0 mm	7 mm	40-50 g (0,39-0,49 N)	
	40.712.38	3,8 mm	7 mm			40.713.38	3,8 mm	7 mm		
	40.714.35	3,5 mm	7 mm			40.715.35	3,5 mm	7 mm		
	40.718.50	5,0 mm	7 mm		80-100 g (0,78-0,98 N)					
	40.766.40	4,0 mm	7 mm	100-130 g (0,98-1,28 N)						



















Anlegezangen · Applying Forceps · Pincas de pose · Pinzas de aplicación · Pinze per posizionare

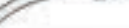

f. p.
 MINI 40.772.21
 STANDARD 40.774.21
 21 cm

Clips „Standard“

Neuro-, Gefäßchirurgie
Neuro, Vascular Surgery
Neurochir., Chir. vascul.
Neurocir., Cir. vascular
Neurochir., Chir. vascolare

STANDARD		permanent				temporary			
		Maulöffnung Opening Ouverture Abertura Apertura	Maullänge Length of Jaws Longueur des mors Largo de la boca Lunghezza dei morsi	Schließkraft Closing Force		Maulöffnung Opening Ouverture Abertura Apertura	Maullänge Length of Jaws Longueur des mors Largo de la boca Lunghezza dei morsi	Schließkraft Closing Force	
				Force de fermeture Fuerza de compresión Forza di compressione				Force de fermeture Fuerza de compresión Forza di compressione	
	40.720.55	5,5 mm	7 mm	110-140 g (1,08-1,37 N)		40.722.53	5,3 mm	40-50 g (0,39-0,49 N)	
	40.724.48	4,8 mm	7 mm						
	40.726.50	5,0 mm	7 mm						
	40.728.68	6,8 mm	7 mm						
	40.730.60	6,0 mm	9 mm		40.731.73	7,3 mm	9 mm		
	40.732.60	6,0 mm	9 mm		40.733.73	7,3 mm	9 mm		
	40.734.50	5,0 mm	9 mm		40.735.63	6,3 mm	9 mm		
	40.738.75	7,5 mm	9 mm						
	40.740.68	6,8 mm	11 mm						
	40.742.65	6,5 mm	11 mm						
	40.744.58	5,8 mm	11 mm						
	40.750.80	8,0 mm	15 mm	100-130 g (0,98-1,28 N)	*40.751.00	10,0 mm	15,0 mm	60-80 g (0,59-0,78 N)	
	40.752.75	7,5 mm	15 mm		*40.753.93	9,3 mm	15,0 mm		
	40.754.65	6,5 mm	15 mm		*40.755.80	8,0 mm	15,0 mm		
	40.770.68	6,8 mm	9 mm	110-140 g (1,08-1,37 N)					
	40.780.38	3,8 mm	7 mm		*PILOT- Clips				
					*40.761.12	12,0 mm	20,0 mm	80-100 g (0,78-0,98 N)	
					*40.763.11	11,5 mm	20,0 mm		

Ophthalmologie
Ophthalmology
Ophtalmologie
Oftalmologia
Oftalmologia

42

Sperrelevatoren
Eye Specula
Blépharostats
Blefarostatos
Blefarostati



cm BARRAQUER (Colibri)
3 42.101.03
4 42.101.04



BOWMAN
42.104.07
7 cm

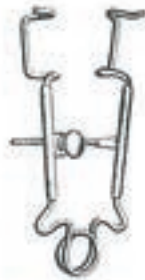

CRITCHETT
42.105.06
7 cm



SMITH
42.106.05
5 cm



CLARK
42.107.08
8 cm



cm GRAEFE
7 42.109.06
9 42.109.07



WEEK
42.110.08
8 cm



ARRUGA
42.111.07
7 cm - rechts -
right - à droite -
a la derecha -
destro



ARRUGA
42.113.07
7 cm - links -
left - à gauche -
a la izquierda -
sinistro

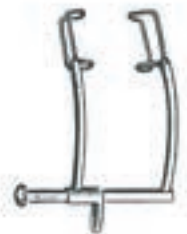

MURDOCK
42.115.05
5 cm



MELLINGER-AXENFELD
42.121.07
7 cm



MELLINGER-AXENFELD
42.123.07
7 cm

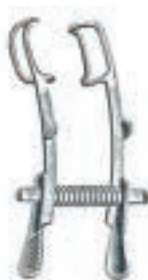

cm MELLINGER
5 42.125.05
7 42.125.07



LISTER-BURCH
42.127.08
8 cm



WILLIAMS
42.128.08
8 cm

Ophthalmologie
Ophthalmology
Ophtalmologie
Oftalmología
Oftalmologia

Sperrelevatoren
Eye Specula
Blépharostats
Blefarostatos
Blefarostali



LANCASTER
42.129.07
7 cm



ZIEGLER
42.130.07
7 cm



CASTROVIEJO
42.132.08
8 cm



PARK
42.133.08
8 cm



MUELLER
42.135.07
7 cm



GOLDSTEIN
42.137.07
3 cm



STEVENSON
42.139.07
7 cm



Lidplatte
Lid Plate
Plaque à paupières
Placa para párpados
Placca per palpebre

JAEGER
42.150.11
11 cm

Starmesser
Cataract Knives
Couteaux à cataracte
Cuchillos para catarata
Coltelli per cataratta



GRAEFE
42.170.00-42.170.03



1/1
42.170.00
Fig. 0



42.170.01
Fig. 1



42.170.02
Fig. 2



42.170.03
Fig. 3



DEUTSCHMANN
42.172.13
13 cm

Ophthalmologie
Ophthalmology
Ophtalmologie
Oftalmología
Oftalmologia

Verschiedene Augenmesser
Various Eye Knives
Couteaux oculaires divers
Cuchillos oculares varios
Cottelli diversi per oculistica



42.180.01-42.218.12



JAEGER
42.180.01 Fig. 1 42.180.02 Fig. 2 42.180.03 Fig. 3



JAEGER 45°
42.181.01 Fig. 1 42.181.02 Fig. 2 42.181.03 Fig. 3



BERENS
42.183.13
13 cm



CASTROVIEJO
42.185.13
4 x 13 mm
13 cm



GRAEFE
42.187.13
13 cm



KNAPP
42.202.01 Fig. 1



42.202.02 Fig. 2



42.202.03 Fig. 3



ZIEGLER
42.210.01 Fig. 1 5 mm 42.210.02 Fig. 2 6 mm 42.210.03 Fig. 3 7 mm



DEAN
42.213.12
12,5 cm



BOWMAN
42.214.04
0,4 mm
13 cm



42.214.08
0,8 mm
13 cm



WHEELER
42.218.12
12 cm

Verschiedene Augenmesser, Fremdkörper-Instrumente, Hornhaut-Schaber und -Dissektoren, Star- und Fremdkörper-Nadeln, Sklerotome, Fixiergabel.
Various Eye Knives, Foreign Body Instruments, Corneal Scarifiers and Dissectors, Cataract and Foreign Body Needles, Sclerotomes, Fixation Fork.
Divers couteaux oculaires, Instruments à corps étrangers, Scarificateurs et dissecteurs cornéens, Aiguilles à cataracte et à corps étrangers, Sclérotomes, Fourchette à fixation.
Cuchillos oculares varios, Instrumentos para cuerpos extraños, escarificadores y disecadores para la córnea, Agujas para catarata y para cuerpos extraños, Horquilla de fijación.
Coltelli oculistici diversi, Strumenti per corpi estranei, Scarificatori e scollatori per la cornea, Aghi per cataratta e per corpi estranei, Sclerotomi, Forchetta di fissaggio.

Ophthalmologie
Ophthalmology
Ophtalmologie
Oftalmología
Oftalmologia



Ophthalmologie
Ophthalmology
Ophtalmologie
Oftalmología
Oftalmologia

Fremdkörper-Instrumente, Hornhaut-Dissektor, Exstirpations-Meißel, Schiel-, Muskel-,
Linsen-, Extraktionshaken, Iris-, Wundhäkchen, Cystotome,
Foreign Body Instruments, Corneal Dissector, Exstirpation Chisel, Strabismus,
Muscle, Lens, and Extraction Hooks, Iris and Delicate Retractors, Cystotomes,
Instruments à corps étrangers, Dissecteur cornéen, Ciseaux à extirpation, Crochets
à strabisme, musculaires, pour la lentille, à extraction et à iris, Kystitomes,
Instrumentos para cuerpos extráneos, Disecador corneal, Cíncel de extirpación,
Ganchos para estrabismo, musculares, para el cristalino y de extracción, Ganchitos
para iris, separadores finos.
Strumenti per corpi estranei, Scollatore corneale, Scalpelli per estirpazione, Uncini
per strabismo, muscolare, per cristallino e per estrazione, Uncini per iride, Divari-
catori fini, Cistitomi.

42



LA FORCE
42.327.12



DIX
42.330.13



ELLIS
42.331.11



WALTON
42.332.12



WALTON
42.334.12



ALVIS
42.336.12



GREEN
42.340.13



ROLLET
42.342.12



GRAEFE
42.351.01 42.351.02 42.351.03
42.352.01 42.352.02 42.352.03
Fig. 1 Fig. 2 Fig. 3



JAMESON
42.353.13



GREEN
42.355.13



STEVENS
42.357.13

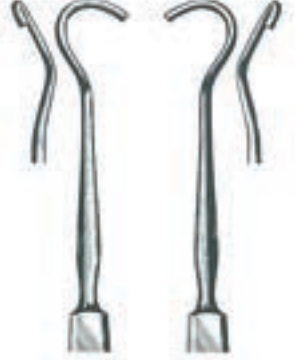

ARRUGA
42.363.01 42.363.02
Fig. 1 Fig. 2



O'CONNOR
42.370.12



WIENER
42.372.13



WIENER
42.373.13



ROLLET
42.376.13



KNAPP
42.377.13



42.380.13



GRAEFE
42.381.13



42.383.13



BECKER
42.386.13

Chalazions-, Star-, Exenterations-Löffel
Scoops and Curettes for Chalazion, Cataract, and Exenteration
Curettes et cuillers pour chalazion, cataracte et exentération
Curetas y cucharillas para chalazión, catarata y exenteración
Curette e cucchiari per calazio, cataratta e palpebre.

Ophthalmologie
Ophthalmology
Ophtalmologie
Oftalmologia
Oftalmologia

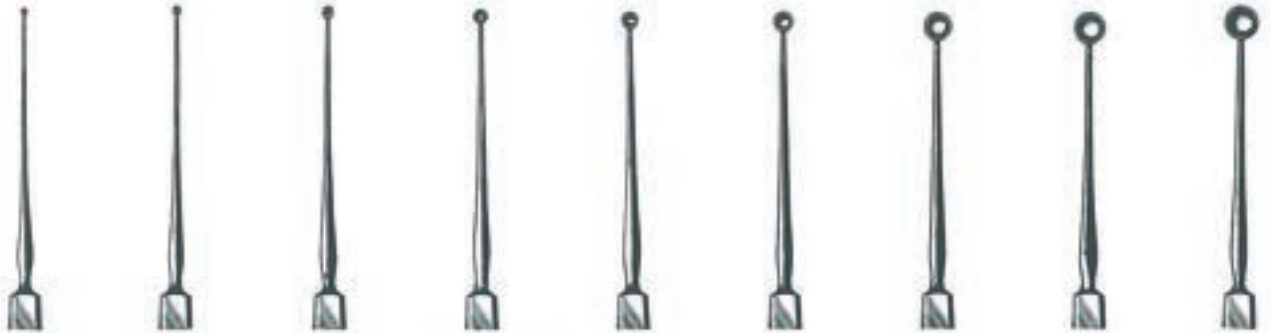

MEYHOEFER

	42.402.05	42.402.10	42.402.15	42.402.18	42.402.20	42.402.25	42.402.35	42.402.40	42.402.45
Ø mm	0,5	1,0	1,5	1,8	2,0	2,5	3,5	4,0	4,5



HEBRA

	42.404.10	42.404.20	42.404.25	42.404.30	42.404.35
Ø mm	1,0	2,0	2,5	3,0	3,5



AXENFELD
42.407.13



GRAEFE

42.410.01	42.410.02
-----------	-----------



DAVIEL

42.412.01	42.412.02
-----------	-----------



KNAPP
42.414.02



BUNGE

42.420.01	42.420.02	42.420.03
-----------	-----------	-----------

Ophthalmologie
Ophthalmology
Ophtalmologie
Ofthalmologia
Ofthalmologia

42

Drahtschlingen
Wire Loops
Anses
Asas
Anse



LANG
42.424.13



WEBER
42.441.01 Fig. 1 42.441.02 Fig. 2



SNELLEN
42.443.13



WILDER
42.445.13 Fig. 1 42.447.13 Fig. 2



ARLT



42.449.01 42.449.02

Iris · Iride



WECKER
42.461.13 42.462.13

CULLER
42.467.13



WELLS
42.482.20



ARRUGA
42.485.13

Schützer
Protector
Protecteur
Protettore

Kauter · Cauter ·
Cautère · Cauterio



WADSWORTH-TODD
42.487.14

Zyklodialyse · Cyclodialysis · Cyclodialyse · Ciclodialisis · Ciclodialisi

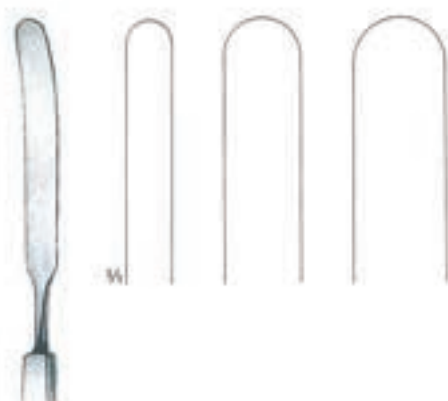

BANGERTER
42.501.06 6 mm 42.501.10 10 mm 42.501.12 12 mm



42.511.13-42.517.09



CASTROVIEJO
42.511.13 1,2x10 mm 42.513.14 1,5x15 mm



ELSCHNIG
42.515.14 1,2x12 mm



CASTROVIEJO
42.517.09 0,8x15 mm

Zyklodialyse-Spatel, Fremdkörper-Instrumente
Cyclodialysis Spatulae, Foreign Body Instruments
Spatules à cyclodialyse, Instruments à corps étrangers
Espátulas para ciclodiálisis, Instrumentos para cuerpos extraños
Spatole per ciclodialisi, Strumenti per corpi estranei

Ophthalmologie
Ophthalmology
Ophtalmologie
Oftalmología
Oftalmologia

42



CASTROVIEJO
42.521.12



WHEELER
42.523.12



mm	CASTROVIEJO
0,5	42.525.05
0,75	42.525.07
1,0	42.525.10



DIX
42.542.12



DIX
42.544.12



DIX
42.546.13



DIX
42.548.13

Markier-Instrumente
Markers
Marqueurs
Marcadores
Marcatori

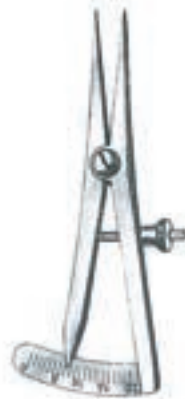

CASTROVIEJO
42.583.07
0-20 mm



CONNIN-AMSLER
42.589.13



DASTOOR
42.590.06
6 cm



HOLTH
42.593.09

Ophthalmologie
Ophthalmology
Ophtalmologie
Oftalmología
Oftalmologia

Tränengang-Dilatatoren
Lachrymal Dilators
Dilatateurs pour canal lacrymal
Dilatadores para canal lacrimal
Dilatatori per canale lacrimale



WILDER
42.602.01 42.602.02 42.602.03



Fig. ZIEGLER
1/2 42.605.12
3/4 42.605.34
5/6 42.605.56



CASTROVIEJO
42.608.12

Tränenkanal-Sonden
Lachrymal Probes
Stylets pour le canal lacrymal
Estiletes para canal lacrimal
Specilli per canale lacrimale



BOWMAN	Fig.	BOWMAN
42.614.00	00/0	42.616.00
42.614.01	0/1	42.616.01
42.614.12	1/2	42.616.12
42.614.23	2/3	42.616.23
42.614.34	3/4	42.616.34
42.614.45	4/5	42.616.45
42.614.56	5/6	42.616.56
42.614.67	6/7	42.616.67
42.614.78	7/8	42.616.78

Fig. 00 0 1 2 3 4 5 6 7 8
Ø mm 0,7 0,8 0,9 1,1 1,3 1,4 1,5 1,6 1,8 1,9

Iris-Pinzetten · Iris Forceps ·
Pinces à iris · Pinzas para iris · Pinze per iride



GRAEFE
42.802.07
7 cm/1 mm



GRAEFE
42.803.07
7 cm/1 mm



GRAEFE
42.804.07
7 cm/1 mm



GRAEFE
42.805.07
7 cm/1 mm

Iris-Pinzetten
Iris Forceps
Pincès à iris
Pinzas para iris
Pinze per iride



GRAEFE
42.810.10
10 cm



GRAEFE
42.811.10
10 cm



GRAEFE
42.813.10
10 cm



GRAEFE
42.820.10
10 cm



GRAEFE
42.821.10
10 cm



GRAEFE
42.823.10
10 cm



STEVENS
42.830.10
10,5 cm



STEVENS
42.831.10
10,5 cm



STEVENS
42.833.10
10,5 cm



STEVENS
42.840.10
10,5 cm



STEVENS
42.841.10
10,5 cm



STEVENS
42.843.10
10,5 cm

Iris-Pinzetten
Iris Forceps
Pinces à iris
Pinzas para iris
Pinze per iride

42



FOERSTER
42.850.08
8,5 cm



FOERSTER
42.851.08
8,5 cm



FOERSTER
42.852.08
8,5 cm



FOERSTER
42.853.08
8,5 cm



HESS
42.855.07
7 cm/0,3 mm



HESS
42.857.07
7 cm/0,3 mm



GILL
42.861.07
7,5 cm/0,3 mm



GILL-HESS
42.863.07
7,5 cm/0,3 cm

Zähne unten
teeth below
dents en bas
dientes abajo
denti in basso



GILL-HESS
42.865.07
7,5 cm/0,3 mm

Zähne seitwärts
lateral teeth
dents laterales
dientes laterales
denti laterali

Ophthalmologie
Ophthalmology
Ophtalmologie
Oftalmologia

Iris-, Strabismus-Pinzetten
Iris, Strabismus Forceps
Pincès à iris et à strabisme
Pinzas para iris y para estrabismo
Pinze per iride e per strabismo

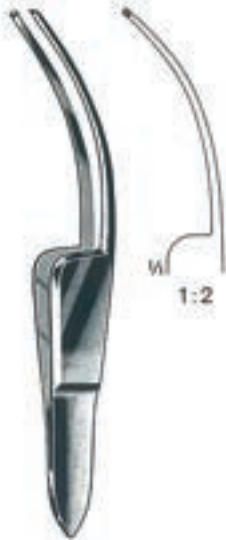

FISCHER
42.869.07
7 cm



BARRAQUER-KATZIN
42.881.07
7 cm/0,4 mm



TROUTMAN (Colibri)
42.883.07
7 cm/0,12 mm

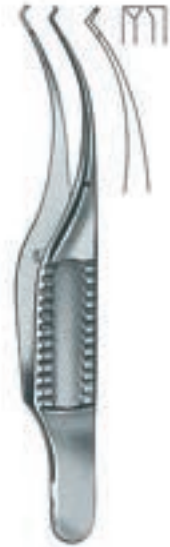

BARRAQUER (Colibri)
42.885.07
7 cm/0,12 mm



BARRAQUER (Colibri)
42.887.07
7 cm/0,12 mm



KIRBY-ARTHUR
42.891.09
9 cm/0,2 mm



KIRBY-ARTHUR
42.893.09
9 cm/0,2 mm



McCULLOUGH
42.902.09
9,5 cm



McCULLOUGH
42.904.09
9,5 cm



JAMESON
42.907.10
L, 10 cm

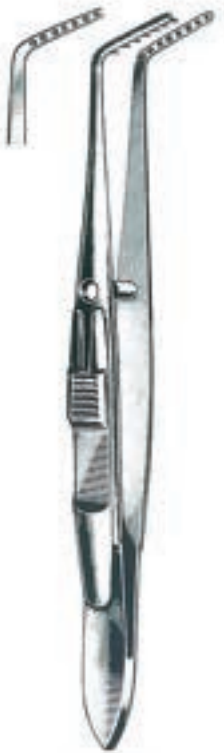

JAMESON
42.908.10
R, 10 cm

Ophthalmologie
Ophthalmology
Ophtalmologie
Oftalmología
Oftalmologia

Strabismus-Pinzetten · Strabismus
Forceps · Pincès à strabisme · Pinzas
para estrabismo · Pinze per strabismo



BONACCOLTO
42.914.10
10 cm



BONACCOLTO
42.916.10
10 cm



BONACCOLTO
42.920.11
11 cm



DASTOOR
42.924.11
11 cm



DASTOOR
42.926.11
11 cm



BISHOP-HARMAN
42.940.05
8,5 cm/0,5 mm



BISHOP-HARMAN
42.940.08
8,5 cm/0,8 mm



BISHOP-HARMAN
42.942.05
8,5 cm/0,5 mm



BISHOP-HARMAN
42.942.08
8,5 cm/0,8 mm



Iris-Pinzetten · Iris Forceps · Pincès à Iris ·
Pinzas para iris · Pinze per iride



Mod. Bonn
42.944.07
7 cm/0,12 mm



Mod. Bonn
42.946.07
7 cm/0,12 mm



Iris-, Muskel-Pinzetten · Iris,
Muscle Forceps · Pincas à iris, mus-
culaires · Pinzas para iris, muscu-
lares · Pinze per iride, muscolari

Ophthalmologie
Ophthalmology
Ophtalmologie
Oftalmologia
Oftalmologia



Mod. Bonn
42.946.10
10 cm/0,12 mm



Mod. Tübingen
42.950.10
42.954.10
10 cm



Mod. Bonn
42.952.10
42.956.10
10 cm/0,12 mm



Mod. Tübingen
42.953.10
42.957.10
10 cm



PRINCE
43.011.10
10 cm
PRINCE
43.013.10
10 cm



BERKE
43.015.20-43.015.27



43.015.20



43.015.27

Rectus



TROUTMAN
43.017.08
8,5 cm/0,8 mm

Vorderkammer-Pinzette
Anterior Chamber Forceps
Pince à chambre antérieure
Pinza para cámara anterior
Pinza per camera anteriore



BARRAQUER
43.021.05
5,5 cm/7 mm

Ophthalmologie
Ophthalmology
Ophtalmologie
Oftalmologia
Oftalmologia

43

Fixier-Pinzetten, Kapsel-Pinzette
Fixation Forceps, Capsular Forceps
Pincés à fixation, pince capsulaire
Pinzas para fijación, pinza capsular
Pinza per fissaggio, pinza capsulare



ELSCHNIG
43.046.11
11 cm



GRAEFE
43.050.11-43.052.11



43.050.11



43.052.11
mit Schloß
with catch
à crémaillère
con cierre
c. cremagliera



LESTER
43.054.09
9 cm



CASTROVIEJO
43.066.09

1:1



CASTROVIEJO
43.067.09

1:1



CASTROVIEJO
43.068.09

2:2



CASTROVIEJO
43.069.09

2:2



BARRAQUER
43.074.10
10 cm



GREEN
43.076.05-43.078.10
10 cm



43.076.05
5 mm
ohne/without/sans
sin/senza



43.076.10
10 mm
ohne/without/sans
sin/senza



43.078.05
5 mm
mit / with / avec / con



43.078.10
10 mm
mit / with / avec / con

Schloß / catch /
crémaillère /
cierre / cremagliera



GILL-ARRUGA
43.101.07
7,5 cm

Kapsel-Pinzetten
Capsular Forceps
Pincers capsulaires
Pinzas capsulares
Pinze capsulare



TERSON
43.103.09
9 cm



KALT
43.106.10
10 cm



ELSCHMIG
43.109.10
10 cm



ARRUGA
43.111.10
10 cm



ARRUGA
43.114.10
10 cm



CASTROVIEJO
43.115.10
10 cm



SCHWEIGGER
43.117.10
10 cm



SCHWEIGGER
43.119.10
10 cm



ELSCHMIG
43.121.10
10 cm



HESS
43.125.06
6 cm



HESS
43.127.06
6,5 cm



FUCHS
43.129.07
7 cm

Ophthalmologie
Ophthalmology
Ophtalmologie
Oftalmologia
Oftalmologia

43

Naht-, Faden-Pinzetten
Suturing, Ligature Forceps
Pincas à sutures et à ligature
Pinzas para suturas y para ligaduras
Pinze per sutura e per legatura



CASTROVIEJO

Zahn
tooth
dent
diente

0,12 mm	43.150.01	
0,3 mm	43.150.03	
0,5 mm	43.150.05	43.151.05
1,0 mm	43.150.10	43.151.10
1,5 mm	43.150.15	43.151.15



MOORFIELD
43.164.10
10 cm



St. MARTIN
43.166.07
7 cm



Mod. Tübingen
43.181.10
43.185.10
10 cm



PAUFIQUE
43.190.08
43.194.08
8,5 cm



PAUFIQUE
43.202.08
43.206.08
8,5 cm



McPHERSON
43.210.10
43.214.10
10 cm



McPHERSON
43.220.10
43.224.10
10 cm

Pinzetten für Chalazion, Entropium, Trachom
Forceps for Chalazio, Entropium, Trachoma
Pinzas à chalazion, à entropion, à granulations du trachome
Pinzas de chalazión, de entropión y para tracoma
Pinze per calazio, per entropio e per trichiasi

Ophthalmologie
Ophthalmology
Ophtalmologie
Oftalmología
Oftalmologia



AYER
43.240.09
9 cm



AYER
43.242.09
9 cm



LAMBERT
43.246.09
9 cm



DESMARRES
43.254.09-43.258.09
9 cm



43.254.09
Fig. 1



43.256.09
Fig. 2



43.258.09
Fig. 3

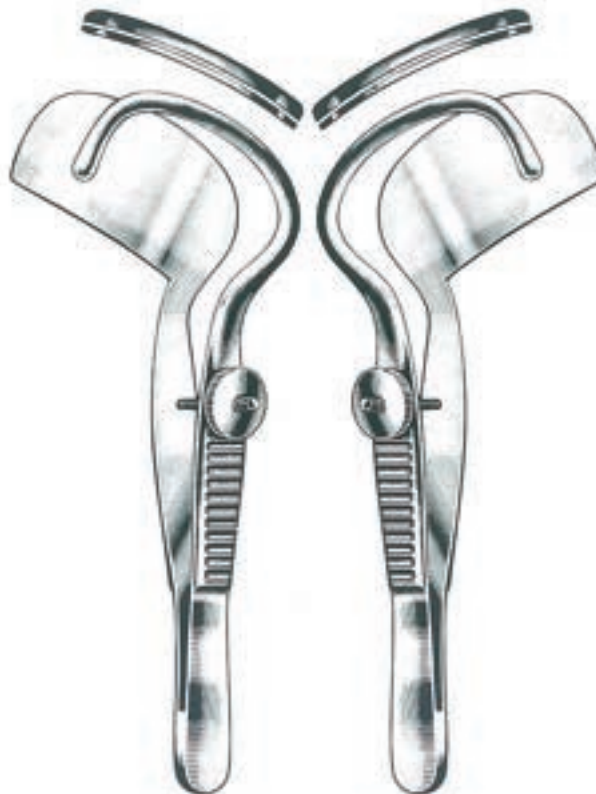

SNELLEN
43.265.10
10 cm

SNELLEN
43.267.10
10 cm



KNAPP-LUER
43.274.11
11 cm

43

Ophthalmologie
Ophthalmology
Ophtalmologie
Oftalmología
Oftalmologia

Augen-Kanülen
Eye Cannula
Canules oculaires
Cánulas oculares
Cannule oculistiche



SCHEIE
43.302.28
1,0 x 28 mm



SCHEIE
43.302.33
1,5 x 33 mm



Mod. Tübingen
43.303.45



Mod. Hamburg
43.305.00



SIMCOE
43.306.00



Mod. Bonn
43.307.00



Mod. Bonn
43.309.00

Hornhaut-Trephinen · Corneal Trephines
Trépan cornéens · Trépanos corneales
Trefine corneali



CASTROVIEJO
43.310.50-43.311.01

Ø mm	CASTROVIEJO
5,0	43.310.50
5,5	43.310.55
6,0	43.310.60
6,5	43.310.65
7,0	43.310.70
8,0	43.310.80
9,0	43.310.90
10,0	43.311.00
11,0	43.311.01



FRANCESCETTI
43.320.50-43.321.00

Ø mm	FRANCESCETTI
5,0	43.320.50
5,1	43.320.51
6,0	43.320.60
6,1	43.320.61
7,0	43.320.70
7,1	43.320.71
8,0	43.320.80
8,1	43.320.81
9,0	43.320.90
9,1	43.320.91
10,0	43.321.00

Ophthalmologie
Ophthalmology
Ophtalmologie
Ofthalmologia
Ofthalmologia



ELLIOT
43.340.00
compl. = 4

Tonometer - Tonómetro
Tonomètre



SCHIOETZ		
	43.404.00	43.406.00
Skala	gerade	schräg
scale	straight	oblique
échelle	droite	oblique
escala	recta	oblicua
scala	retta	obliqua



43.408.00

Augen-Magnet
Eye Magnet
Aimant à corps étrangers
Imán para cuerpos extranjeros
Calamita per corpi estranei

Cilien-Pinzetten · Cilia Forceps
Pincas à épiler les cils · Pinzas
depilatorias · Pinze depilatorie



BEER
43.420.09
9 cm



DOUGLAS
43.422.09
9 cm



LITTAUER
43.424.08
8,5 cm



BARRAQUER
43.425.10
10,5 cm



43.426.09
9 cm



GRADLE
43.428.09
9,5 cm

Otologie
Otology
Otologie
Otologia
Otologia

Ohr-Spekula
Ear Specula
Spéculum auriculaires
Espéculos auriculares
Specoli auricolari



mm Ø
 ① = 3
44.010.30
 ② = 4,5
44.010.45
 ③ = 5,5
44.010.55
 ④ = 6,5
44.010.65
 ⑤ = 7,5
44.010.75

HARTMANN
44.010.00
Set = 4



mm Ø
 ① = 5,5
44.012.55
 ② = 6,5
44.012.65
 ③ = 7,5
44.012.75

TOYNBEE
44.012.00
Set = 3



mm Ø
 ① = 4,5
44.014.45
 ② = 5,5
44.014.55
 ③ = 6,5
44.014.65
 ④ = 7,5
44.014.75

GRUBER
44.014.00
Set = 4



mm Ø
 ① = 4,5
44.015.45
 ② = 5,5
44.015.55
 ③ = 6,5
44.015.65
 ④ = 7,5
44.015.75

GRUBER
44.015.00
Set = 3



① 44.018.50
5 mm
 ② 44.018.60
6 mm
 ③ 44.018.70
7 mm
 ④ 44.018.80
8 mm

BOUCHERON
44.018.00
Set = 4

① 6,5
② 7
③ 8 mm Ø



BRUENINGS
44.030.04
compl.



SIEGLE
44.036.03
compl.

Stimmgabeln
Tuning Forks
Diapasons
Diapasones
Diapason



DIMEDA Alu

- 44.060.01
C 128
- 44.060.02
C¹ 256
- 44.060.03
C² 512
- 44.060.04
C³ 1024
- 44.060.05
C⁴ 2048



DIMEDA Alu
44.061.00
compl.

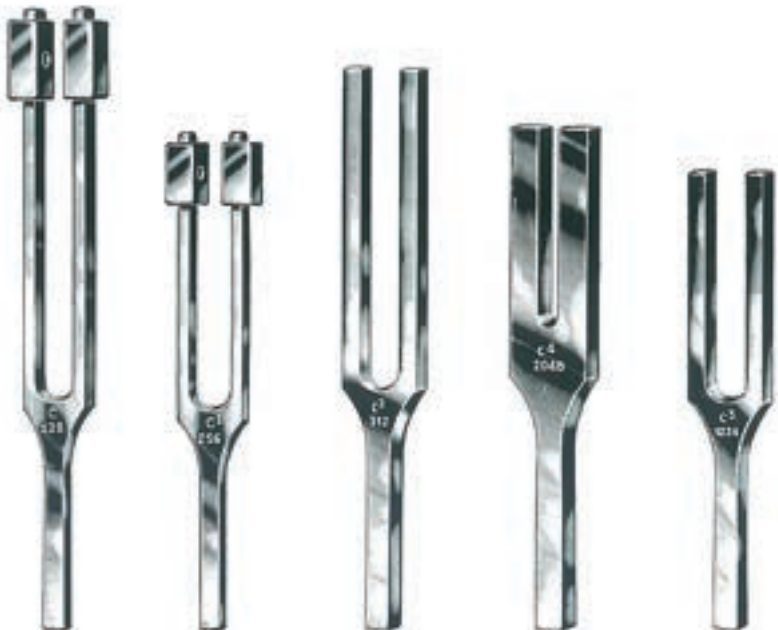

HARTMANN

- 44.070.01
C 128
- 44.070.02
C¹ 256
- 44.070.03
C² 512
- 44.070.04
C³ 1024
- 44.070.05
C⁴ 2048



HARTMANN
44.071.00
compl.

44

Otologie
Otology
Otologie
Otologia
Otologia



LUCAE
44.074.01
C 128



44.075.00
neurol.



RYDEL-SEIFFER
44.076.01
C 64/c 128

Lärmapparat
Noise Apparatus
Assourdisseur
Ensordecedor
Assordatore



BARANY
44.080.00

Pulverbläser
Powder Blowers
Lance-Poudre
Lanzapolvero
Insuffiatori per polvere

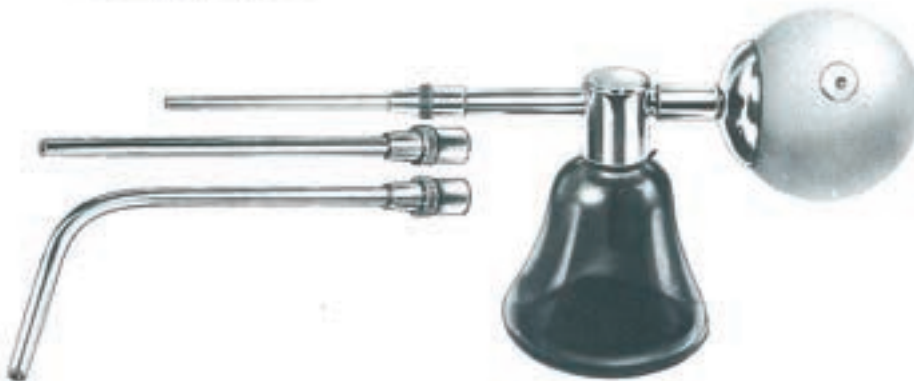

KABERSKE
44.090.00
30 cc



KABERSKE
44.090.01
30 cc

Otologie
Otology
Otologie
Otología
Otologia

Luftdusche, Ohrspritze
Air Bag, Ear Syringe
Insufflateur d'air, Seringue
Insuflador de aire, Jeringa
Insoffiatore d'aria, Siringa



44.091.03



44.091.04
4 mm Ø



44.091.15
15 mm Ø



44.091.17
17 mm Ø



44.091.22
22 mm Ø

POLITZER

44.091.00 = incl. 44.091.15, 44.091.17, 44.091.22, 44.091.03
44.091.01 = incl. 44.091.15, 44.091.17, 44.091.22, 44.091.03, 44.091.04



ml	REINER
50	44.096.50
75	44.096.75
100	44.097.10
150	44.097.15

**Küretten · Curettes ·
Curettes · Curetas ·
Curette**

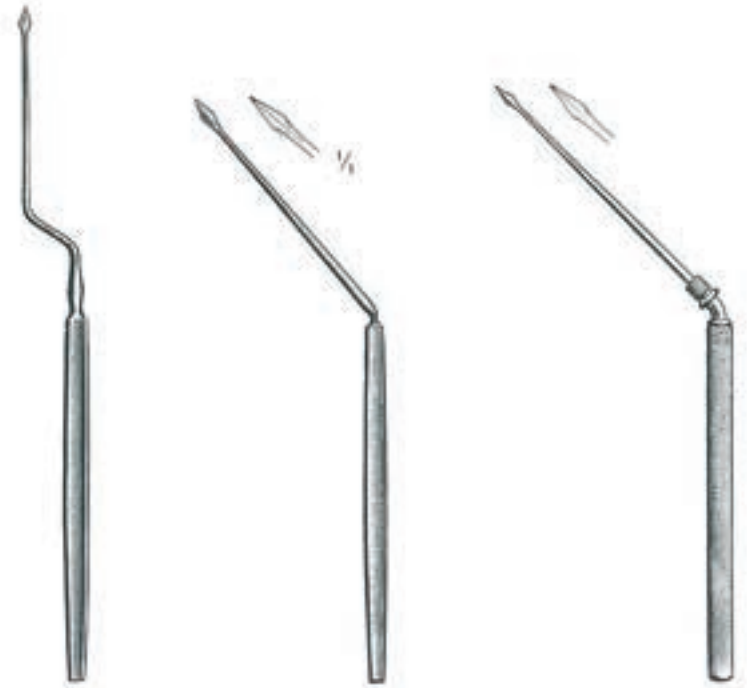
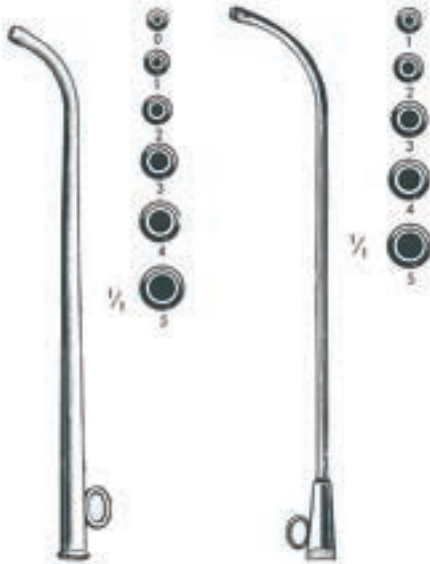

	Fig. 00	0	1	2	3	4	5
stumpf · blunt mousses romas smusse	44.109.00	44.110.00	44.110.01	44.110.02	44.110.03	44.110.04	44.110.05
scharf · sharp tranchantes cortantes taglianti	44.111.00	44.112.00	44.112.01	44.112.02	44.112.03	44.112.04	44.112.05
stumpf · blunt mousses romas smusse	44.114.00	44.115.00	44.115.01	44.115.02	44.115.03	44.115.04	44.115.05
scharf · sharp tranchantes cortantes taglianti	44.116.00	44.117.00	44.117.01	44.117.02	44.117.03	44.117.04	44.117.05

Otologie
Otology
Otologie
Otologia
Otologia

Katheter, Paracentesenadeln, Ohrmesser, Ohröffel
Catheters, Paracentesis Needles, Ear Knives, Ear Spoons
Sondes; Aiguilles à paracentèse, Couteaux auriculaires, Cuillers
Cateteres, Aguja para paracentesis, Cuchillos auriculares, Cucharas
Cateteri, Aghi per paracentesi, Coltelli auricolari, Cucchiari

44



POLITZER
44.150.18
18 cm

POLITZER
44.151.16
16,5 cm

POLITZER
44.153.16

Fig.	HARTMANN	ITARD
0	44.131.00	
1	44.131.01	44.133.01
2	44.131.02	44.133.02
3	44.131.03	44.133.03
4	44.131.04	44.133.04
5	44.131.05	44.133.05



POLITZER
44.160.15
15 cm



SEXTON
44.162.18
18 cm



SEXTON
44.164.17
17 cm



SEXTON
44.165.17
17 cm



GROSS
44.170.12
12 cm



GROSS
44.171.12
12 cm

Schlingen, Hakchen, Pinzetten, Schnurer
Loops, Hooklets, Dressing Forceps, Snares
Anses, Crochets, Pinces, Serrenoud
Asas, Ganchitos, Pinzas, Cierranudos
Anse, Uncinetti, Pinze, Serranodi

Otologie
Otology
Otologie
Otologia
Otologia

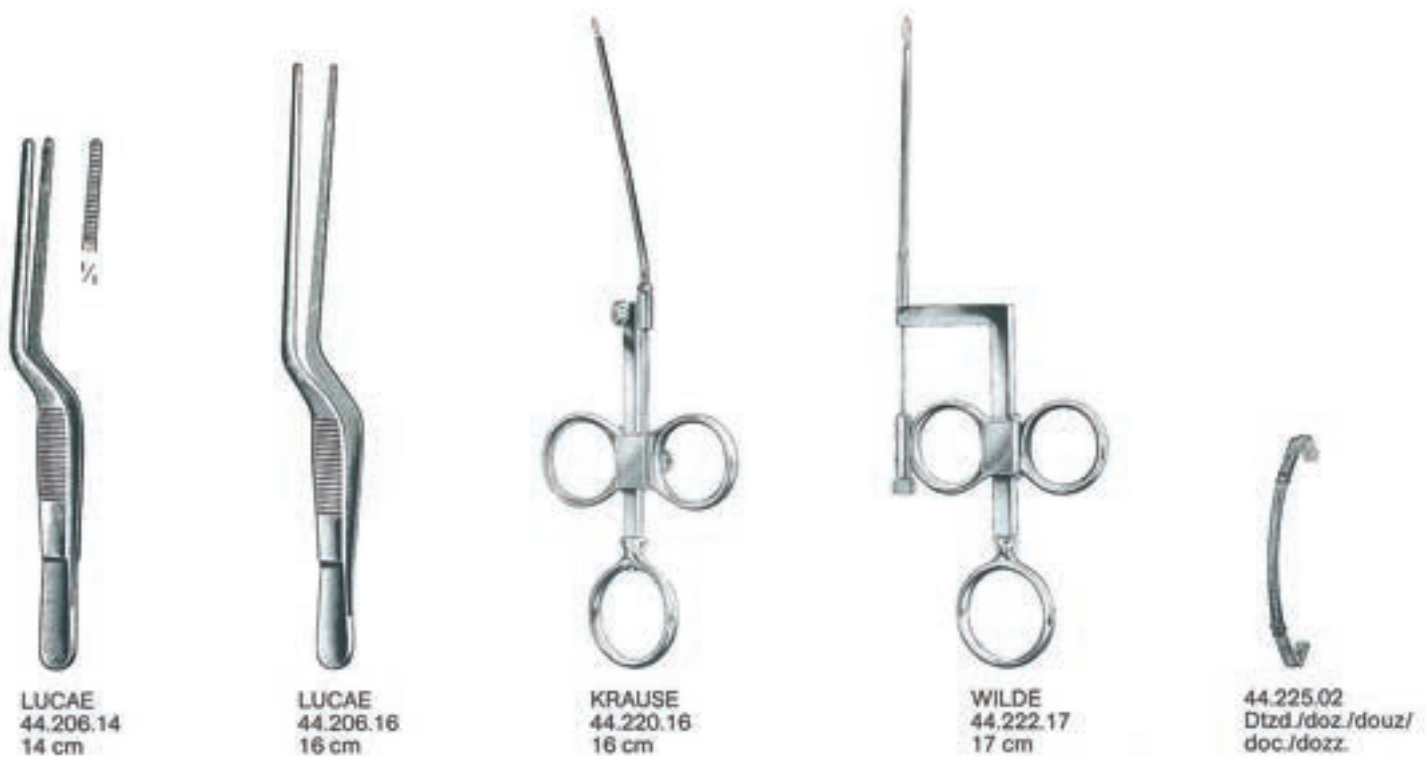
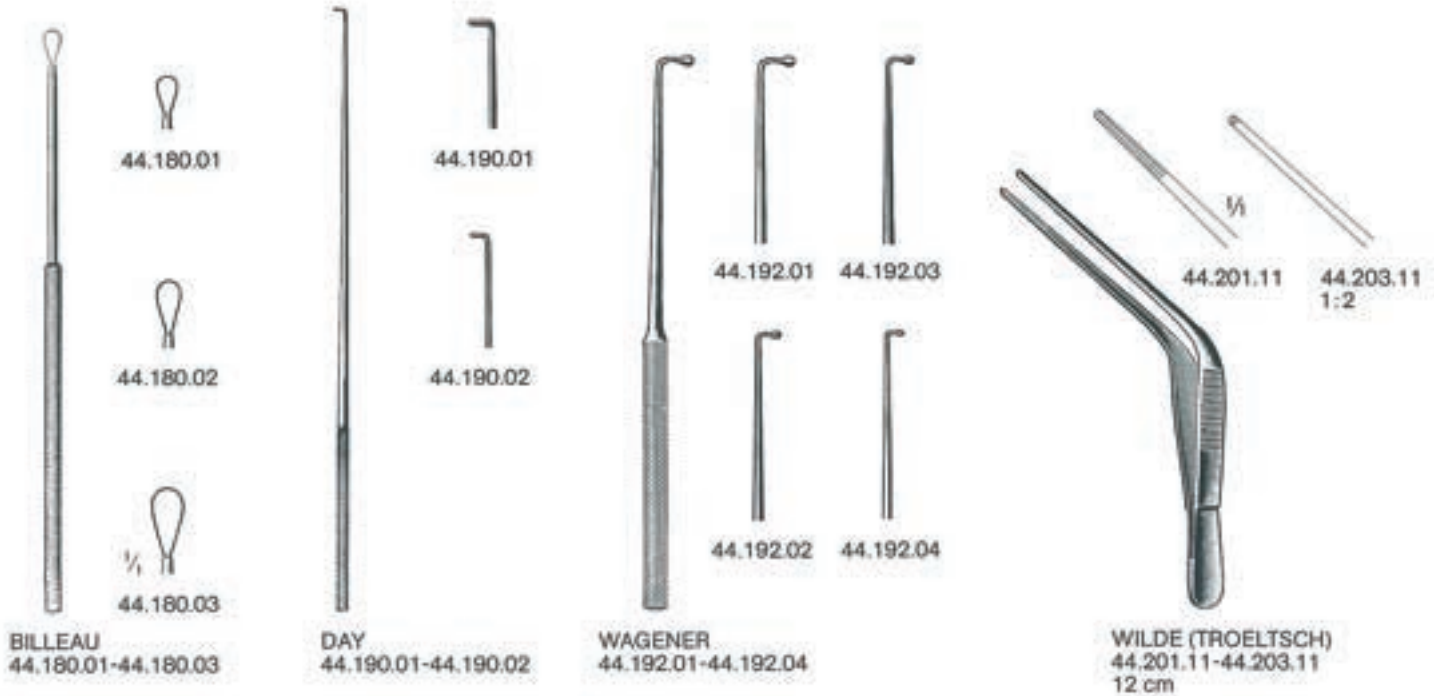

Ohrzängchen
Ear Forceps
Pincès auriculaires
Pinzas auriculares
Pinze auricolari

44



TILLEY
44.243.14
14 cm



LITTAUER
44.245.12
12 cm



HARTMANN
44.241.12
12 cm



HARTMANN
44.241.14
14 cm



QUIRE
44.251.10
10 cm

Fremdkörperheber
Foreign Body Levers
Leviers pour corps étrangers
Elevadores para cuerpos extranjerios
Leve per corpi estranei



BUCK
44.253.11
11 cm



44.255.08-44.275.08



HARTMANN-WULLSTEIN
44.255.08
8,5 cm



HARTMANN-WULLSTEIN
44.257.08
8,5 cm



cm	HARTMANN
8,5	44.261.08
14,0	44.261.14
16,0	44.261.16



cm	HARTMANN
8,5	44.263.08
14,0	44.263.14



HARTMANN
44.265.08
8,5 cm



Ø mm	HARTMANN
2,0	44.267.20
2,5	44.267.25
3,0	44.267.30

8,5 cm

○ 3 mm



HARTMANN
44.269.30
8,5 cm



STRUEMPEL
44.271.08
8,5 cm



HARTMANN
44.273.08
8,5 cm

○ 2 mm



HARTMANN-HOFFMANN
44.275.08
8,5 cm

Otologie
Otology
Otologie
Otologia
Otologia

Mikro-Ohrscherchen
Micro Ear Scissors
Ciseaux auriculaires micro
Tijeras auriculares micro
Forbici auricolari micro



44.310.40-44.322.70



BELLUCCI
44.310.40
micro mini
4 mm



BELLUCCI
44.312.55
micro standard
5,5 mm



BELLUCCI
44.313.55
micro standard
5,5 mm



BELLUCCI
44.315.55
micro standard
5,5 mm



BELLUCCI
44.317.55
micro standard
5,5 mm



SHEA
44.320.70
7,0 mm



SHEA
44.321.70
7,0 mm



SHEA
44.322.70
7,0 mm

Mikro-Ohrzängchen
Micro Ear Forceps
Pinces auriculaires micro
Pinzas auriculares micro
Pinze auricolari micro



44.350.40-44.360.35



44.350.40
4 mm



44.350.70
7 mm



44.352.40
4 mm



44.353.60
6 mm



44.355.60
6 mm



44.357.40
4 mm



44.359.40
4 mm













44.360.35
3,5 mm

Mikro-Ohrzängchen
Micro Ear Forceps
Pinces auriculaires micro
Pinzas auriculares micro
Pinze auricolari micro

44



		
44.362.45 4,5 mm	44.363.45 4,5 mm	44.365.45 4,5 mm
		
44.367.50 5,0 mm	44.369.50 5,0 mm	GREVEN 44.370.50 5,0 mm
		
McGEE 44.371.40 0,8x4,0 mm	COS 44.373.30 1,8x0,8x3,0 mm	JUERS 44.375.60 6 mm
		
JUERS 44.377.60 6 mm	HAUGH 44.381.30 45° 3 mm	HAUGH 44.383.30 45° 3 mm



Hammerkopf-Zwickzängchen
Malleus Nippers
Pinces pour la tête du marteau
Pinzas para la cabeza del martillo
Pinze per la testa del martello

micro	aufwärts upward en haut arriba in alto	mini
 44.385.01		 44.387.01
 44.385.02	abwärts downward en bas abajo in basso	 44.387.02

Mikro-Ohrzängchen
Micro Ear Forceps
Pinces auriculaires micro
Pinzas auriculares micro
Pinze auricolari micro

Modelle mit Ringgriff
Ring Handle Patterns
Modèles manches à anneaux
Modelos mangos con anillos
Modelli manici con anelli

Modelle mit Bleistiftgriff
Pencil Handle Patterns
Modèles manches crayon
Modelos mango en forma de lapiz
Modelli manico forma matita



44.410.00		44.430.00
44.412.00		44.432.00
44.413.00		44.433.00
44.415.00		44.435.00
44.417.00		44.437.00
44.419.00		44.439.00
		44.439.08



44.420.00		44.440.00
44.422.00		44.442.00
44.423.00		44.443.00
44.425.00		44.445.00
44.427.00		44.447.00
44.429.00		44.449.00

Mikro-Ohrzängchen
Micro Ear Forceps
Pinces auriculaires micro
Pinzas auriculares micro
Pinze auricolari micro

44



44.510.00-44.549.00
 micro
 RG

Modelle mit Ringgriff
 Ring handle Patterns
 Modèles manches à anneaux
 Modelos mangos con anillos
 Modelli manici con anelli

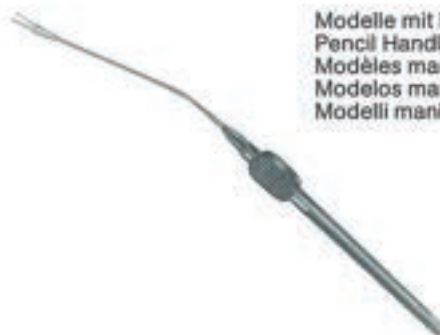

44.610.00-44.649.00
 micro
 BG

Modelle mit Bleistiftgriff
 Pencil Handle Patterns
 Modèles manches crayon
 Modelos mango en forma de lapiz
 Modelli manico forma matita

44.510.00		44.610.00
44.511.00		44.611.00
44.513.00		44.613.00
44.514.00		44.614.00
44.515.00		44.615.00
44.516.00		44.616.00
44.517.00		44.617.00
44.519.00		44.619.00
44.520.00		44.620.00
44.521.00		44.648.00

Ø 1 mm Ø 1,5 mm Ø 2 mm Ø 2,5 mm

44.522.00 44.528.00 44.534.00 44.540.00

44.523.00 44.529.00 44.535.00 44.541.00

44.525.00 44.531.00 44.537.00 44.543.00

44.527.00 44.533.00 44.539.00 44.545.00

44.546.00 44.646.00

44.547.00 44.647.00

44.548.00 44.648.00

44.549.00 44.649.00

Ø 1 mm Ø 1,5 mm Ø 2 mm Ø 2,5 mm

44.622.00 44.628.00 44.634.00 44.640.00

44.623.00 44.629.00 44.635.00 44.641.00

44.625.00 44.631.00 44.637.00 44.643.00

44.627.00 44.633.00 44.639.00 44.645.00

Mikro-Ohrzängchen
Micro Ear Forceps
Pincès auriculaires micro
Pinzas auriculares micro
Pinze auricolari micro

Modelle mit Ringgriff
Ring Handle Patterns
Modèles manches à anneaux
Modelos mangos con anillos
Modelli manici con anelli

Modelle mit Bleistiftgriff
Pencil Handle Patterns
Modèles manches crayon
Modelos mango en forma de lapiz
Modelli manico forma matita



44.550.00-44.589.00
micro-mini
RG

44.650.00-44.689.00
micro-mini
BG

44.550.00		44.650.00
44.551.00		44.651.00
44.553.00		44.653.00
44.554.00		44.654.00
44.555.00		44.655.00
44.556.00		
44.557.00		44.657.00
44.559.00		44.659.00
44.560.00		44.660.00
44.561.00		
44.562.00		44.662.00
44.563.00		44.663.00
44.565.00		44.665.00
44.567.00		44.667.00
44.586.00		44.686.00
44.587.00		44.687.00
44.588.00		44.688.00
44.589.00		44.689.00

Otologie
 Otology
 Otologie
 Otologia
 Otologia



SCHUKNECHT
 44.701.01



SCHUKNECHT
 44.701.02



SCHUKNECHT
 44.703.15
 15,5 cm



WULLSTEIN
 44.704.15
 15,5 cm



TABB
 44.705.15
 15,5 cm



PLESTER
 44.706.35
 15,5 cm/3,5 mm Ø

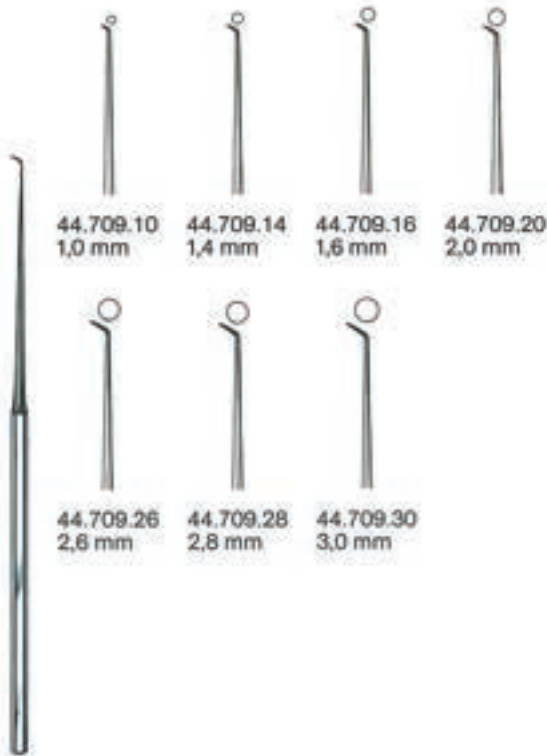

ROSEN
 44.709.10-44.709.30



BARBARA 44.710.15
 BARBARA 44.711.15
 BARBARA 44.713.15
 ROSEN 44.715.15

	25°	45°	90°	
mm	BARBARA	BARBARA	BARBARA	BARBARA
0,3	44.720.03	44.722.03	44.724.03	44.725.05 = 0,5 mm
0,6	44.720.06	44.722.06	44.724.06	44.725.10 = 1,0 mm
1,0	44.720.10	44.722.10	44.724.10	
1,2		44.722.12	44.724.12	
1,5		44.722.15	44.724.15	
2,0		44.722.20	44.724.20	
2,5		44.722.25	44.724.25	

44.710.15-44.725.10

Otologie
Otology
Otologie
Otologia
Otologia



mm	90°	90°	mm	McGEE	McGEE	BARBARA
0,3	44.730.03	44.732.03	0,5	44.733.05	44.735.05	44.736.15
0,6	44.730.06	44.732.06	1,0	44.733.10	44.735.10	15,5 cm
1,0	44.730.10	44.732.10				

ROSEN
44.737.15
15,5 cm

mm	25°	25°	45°	45°
0,3	44.741.03	44.743.03	44.745.03	44.747.03
0,6	44.741.06	44.743.06	44.745.06	44.747.06
1,0	44.741.10	44.743.10	44.745.10	44.747.10



FISCH
44.751.16-44.757.16



LEMPERT
44.802.16-44.805.16



44.802.16
2 mm



44.803.16
2 mm



44.805.16
3 mm



mm		
1,0/1,2	44.760.01	
1,5/1,8	44.760.02	

mm		
1,0/1,2	44.762.01	
1,5/1,8	44.762.02	

HOUSE
44.760.01-44.762.02



HOUSE
44.766.35-44.766.50

3,5 mm	44.766.35
4 mm	44.766.40
4,5 mm	44.766.45
5 mm	44.766.50



LEMPERT
44.807.20
20,5 cm



mm	PASSOW
2x2	44.810.02
3x3	44.810.03



MUCK
44.812.13
13 cm

Rhinologie
Rhinology
Rhinologie
Rinología
Rinologia

46

Nasenspekula
Nasal Specula
Spéculum nasaux
Espéculos nasales
Specoli nasali

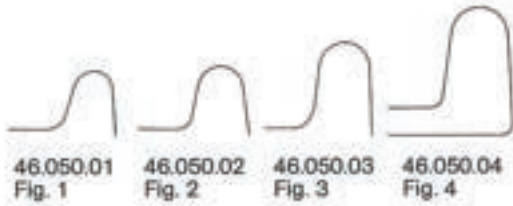

46.050.01 Fig. 1 46.050.02 Fig. 2 46.050.03 Fig. 3 46.050.04 Fig. 4

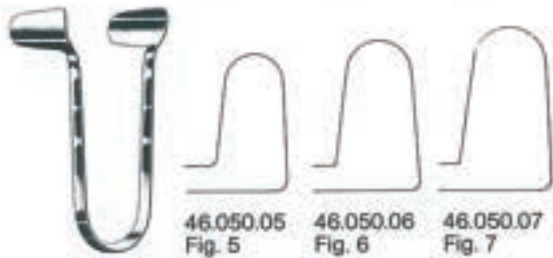

THUDICHUM
46.050.01-46.050.07



46.060.01
Fig. 1



46.060.02
Fig. 2



46.060.03
Fig. 3



VOLTOLINI
46.060.01-46.060.03



HARTMANN-HALLE
46.102.01-46.102.03
15 cm



Mod. Wien · Vienna ·
Vienne · Viena

Baby · Bébé	46.112.01
Kind · child · enf. · niño · bamb.	46.112.02
Erw. · Adult.	46.112.03



Mod. Wien · Vienna
Vienne · Viena
46.113.03
leichtes Modell
lightweight
mod. léger
mod. leggero

Rhinologie
Rhinology
Rhinologie
Rinologia
Rinologia

Nasenspekula
Nasal Specula
Spéculum nasaux
Espéculos nasales
Specoli nasali



TIECK-HALLE
46.116.13
13,5 cm



KILLIAN
46.120.35-46.120.90
13 cm

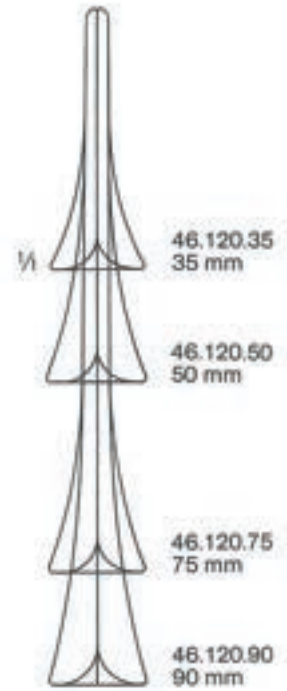

COTTLE
46.124.35-46.124.90
14 cm



COTTLE
46.126.35-46.126.90
schwarz · black · noirs
negros · neri
14 cm

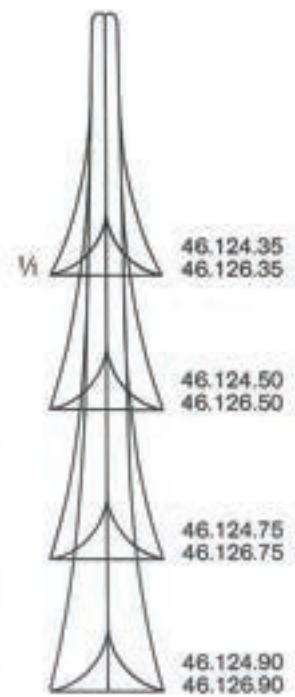

Rhinologie
Rhinology
Rhinologie
Rinologia
Rinologia

46



YANKAUER
46.131.19
19 cm



MICHEL
46.139.12-46.139.18
25 cm



46.139.12
12 mm



46.139.14
14 mm



46.139.16
16 mm



46.139.18
18 mm



TROELTSCH
46.151.15
15 cm

TROELTSCH
46.151.18
18 cm



JANSEN
46.154.20
20 cm



HARTMANN
46.161.16
16 cm



HARTMANN
46.161.20
20 cm

Rhinologie
Rhinology
Rhinologie
Rinología
Rinologia

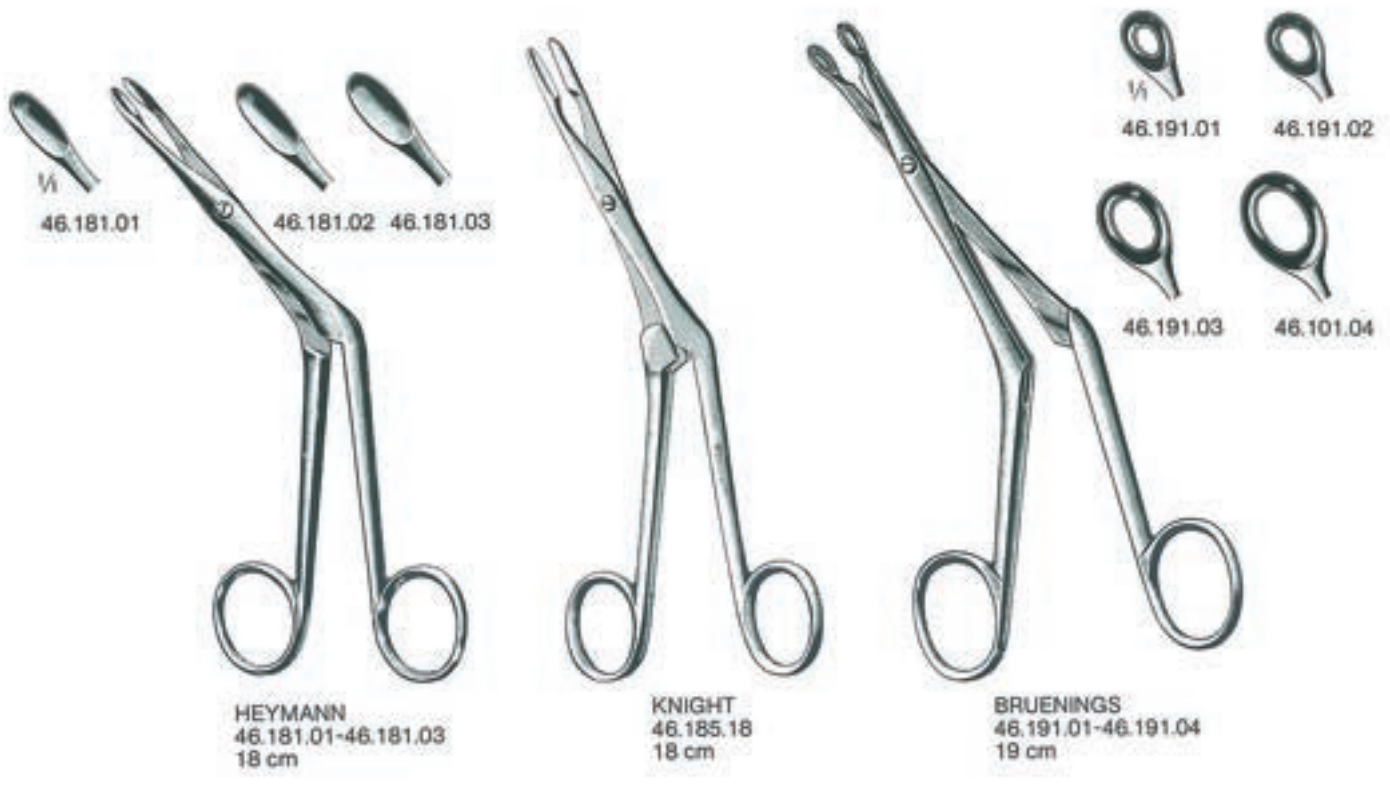
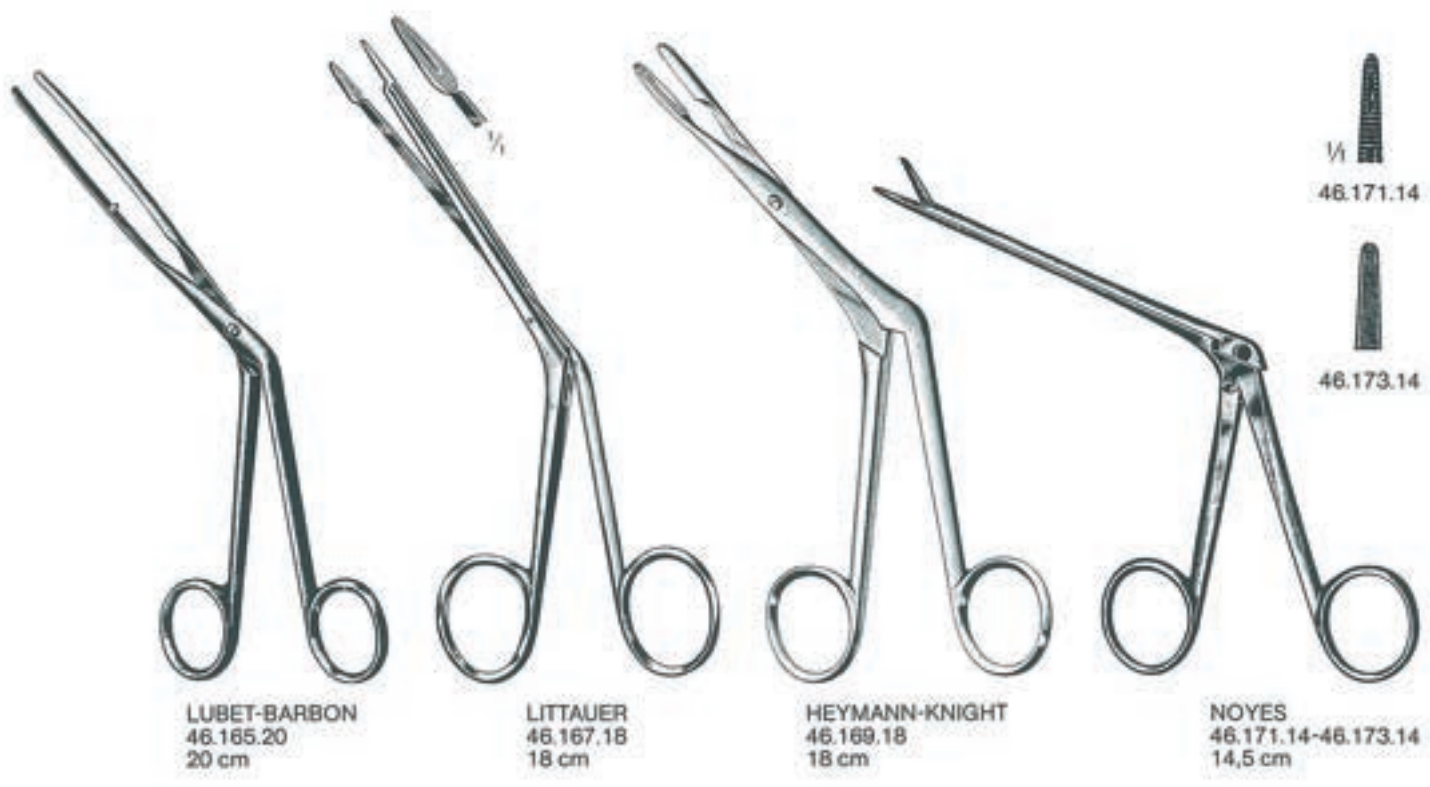

Rhinologie
Rhinology
Rhinologie
Rinologia
Rinologia

Scharfe Nasenzangen
Nasal Cutting Forceps
Pinces coupantes nasales
Pinzas cortantes nasales
Pinze taglienti nasali

46



1/4
46.195.01
Fig. 1

1/4
46.195.02
Fig. 2

LUC
46.195.01-46.195.02
19 cm

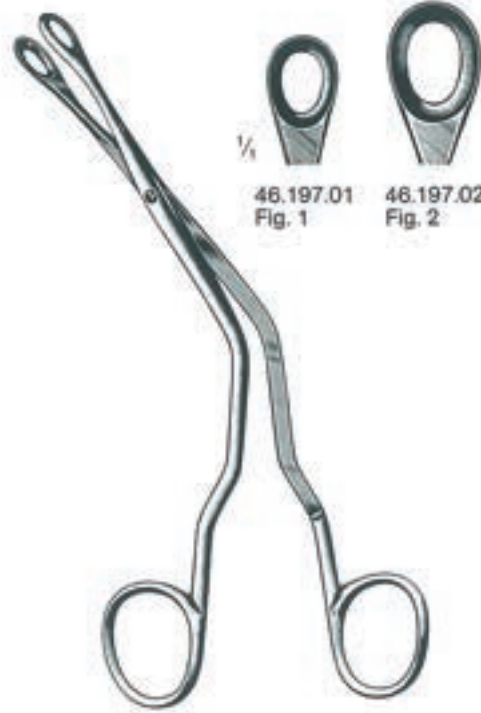

1/4
46.197.01
Fig. 1

1/4
46.197.02
Fig. 2

LUC
46.197.01-46.197.02
19 cm

ohne Hals
without neck
sans cou
sin cuello
senza collo



1/4
46.221.01
Fig. 1

1/4
46.221.02
Fig. 2

1/4
46.221.03
Fig. 3

1/4
46.221.04
Fig. 4

1/4
46.221.05
Fig. 5

mit Hals
with neck
avec cou
con cuello
con collo



1/4
46.223.01
Fig. 1

1/4
46.223.02
Fig. 2

1/4
46.223.03
Fig. 3

1/4
46.223.04
Fig. 4

1/4
46.223.05
Fig. 5

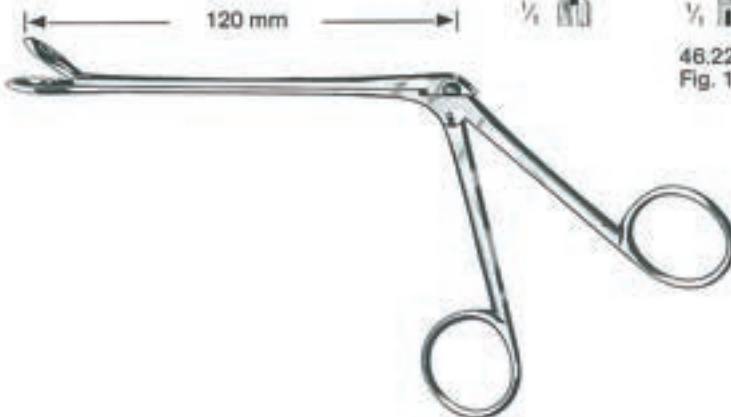

WEIL-BLAKESLEY
46.221.01-46.223.05

Rhinologie
Rhinology
Rhinologie
Rinologia
Rinologia

Scharfe Nasenzangen
Nasal Cutting Forceps
Pincès coupantes nasales
Pinzas cortantes nasales
Pinze taglianti nasali



46.231.01-46.237.03
19 cm



STRUYCKEN
46.231.01
Fig. 1



STRUYCKEN
46.231.02
Fig. 2

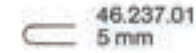

46.237.01
5 mm

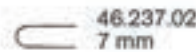

46.237.02
7 mm



46.237.03
9 mm



MYLES



46.235.05



46.235.07



46.235.09



46.235.11



HARTMANN



RUBIN
46.251.21
21 cm

Septum-Quetschzange
Septum Crushing Forceps
Pince à écraser la cloison
Pinza para magullar tabique
Pinza per ammaccare il setto

Rhinologie
Rhinology
Rhinologie
Rinología
Rinologia

46



mm x mm	KERRISON
3x3	46.303.03
4x4	46.303.04
5x5	46.303.05
6x6	46.303.06

17 cm



HAJEK-KOFLER
46.305.01-46.305.02



mm	CITELLI
1,0	46.311.10
2,5	46.311.25
4,0	46.311.40



BEYER
46.315.20
2,0 mm



HAJEK-CLAUS
46.320.20
20 cm

Rhinologie
 Rhinology
 Rhinologie
 Rinología
 Rinologia



MIDDLETON-JANSEN
 46.323.19
 19 cm



MIDDLETON-JANSEN
 46.325.19
 19 cm



Ø mm	LICHTWITZ
1,5	46.340.15
1,8	46.340.18
2,0	46.340.20

Luer-Lock
 10 cm



KILLIAN
 46.341.03
 14 cm/3 mm Ø



KRAUSE
 46.351.26
 26 cm



WILDE
 46.352.24
 24 cm



46.355.03
 0,3 mm

Rhinologie
Rhinology
Rhinologie
Rinologia
Rinologia

46

Nasenmesser
Nasal Knives
Bistouris nasaux
Bisturios nasales
Cottelli nasali



JOSEPH
46.370.16-46.373.16



46.370.16
stumpf · blunt · mousses
romos · smussi



46.371.16



46.372.16
spitz · pointed · pointus
puntiagudos · acuti



46.373.16



FREER
46.374.15
15 cm



FREER
46.375.19
19 cm

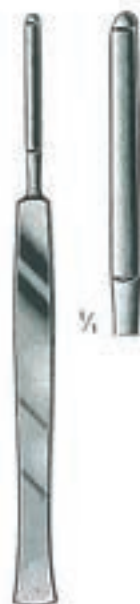

JOSEPH
46.376.16
16 cm



CONVERSE
46.379.16
16 cm



COTTLE
46.380.15
15 cm



46.382.15



COTTLE
46.384.15



46.385.15

Septum-Messer
Septum Knives
Couteaux pour la cloison
Cuchillos para tabique
Coltelli per setto

Rhinologie
Rhinology
Rhinologie
Rinologia
Rinologia

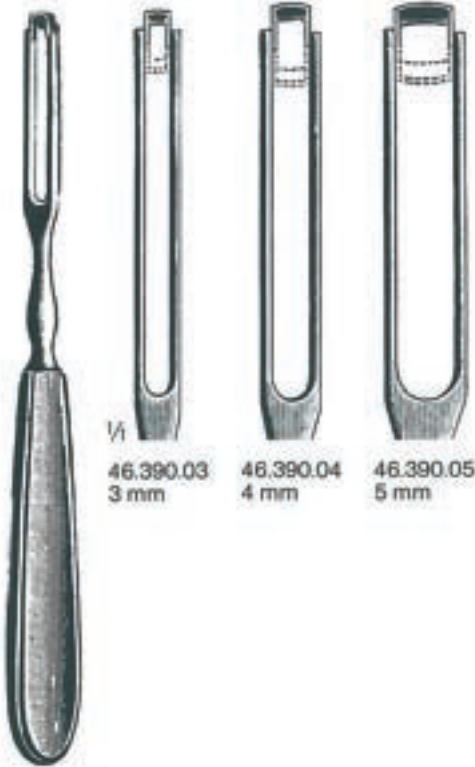

1/4
46.390.03 3 mm
46.390.04 4 mm
46.390.05 5 mm

BALLENGER
46.390.03-46.392.05
20 cm



1/4
46.392.03 3 mm
46.392.04 4 mm
46.392.05 5 mm

Septum-Elevatorien
Septum Elevators
Élévateurs pour la cloison nasale
Elevadores para tabique
Elevatori per setto



BRUENINGS
46.398.16
16,5 cm

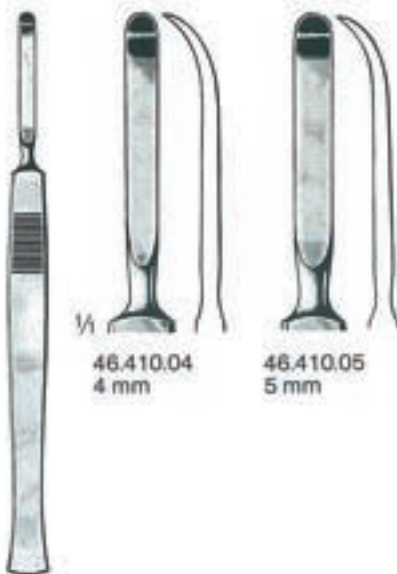

1/4
46.410.04 4 mm
46.410.05 5 mm

McKENTY
46.410.04-46.410.05
15 cm



ROGER
46.413.19
19 cm



FREER
46.415.18
18 cm



FREER
46.417.19
19 cm



FREER
46.419.19
19 cm

Rhinologie
Rhinology
Rhinologie
Rinologia
Rinologia

46



COTTLE
46.421.23
23 cm



COTTLE
46.423.22
22 cm



JOSEPH
46.425.16
16 cm



COTTLE
46.425.19
19 cm



KILLIAN
46.426.22
22 cm



HAJEK-BALLEGER
46.428.21
22 cm



BALLEGER
46.430.22
22 cm



FREER
46.450.04
4 mm



FREER
46.451.04
4 mm

Nasenplastik-Meißel
Rhinoplastic Chisels
Ciseaux-burins pour la plastique nasale
Cinceles para la plástica nasal
Scalpellini per plastica nasale

Rhinologie
Rhinology
Rhinologie
Rinologia
Rinologia

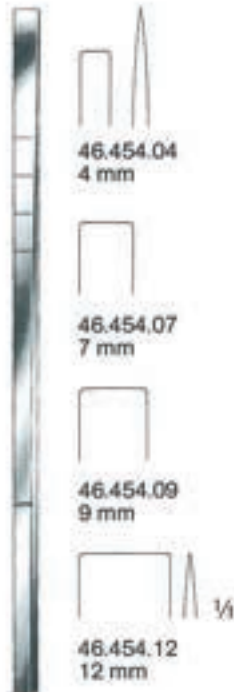

COTTLE
46.454.04-46.454.12
18 cm



COTTLE
46.455.06
18 cm/6 mm

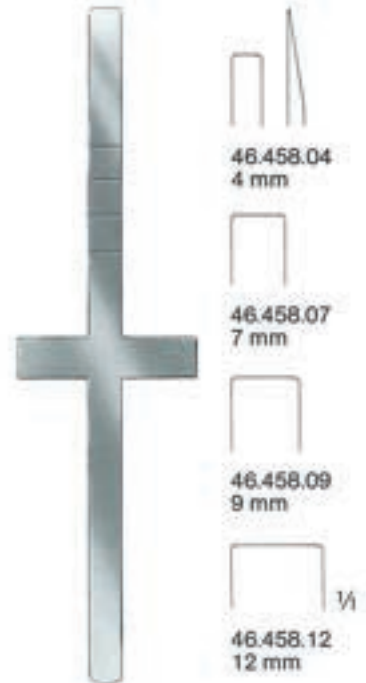

COTTLE
46.458.04-46.458.12

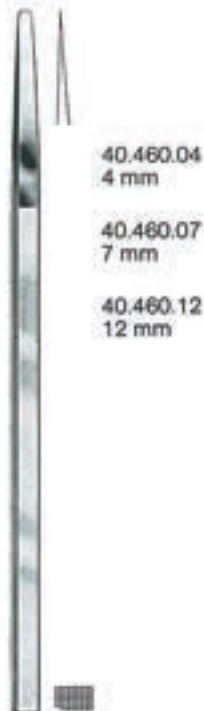

COTTLE
46.460.04-46.460.12
18 cm

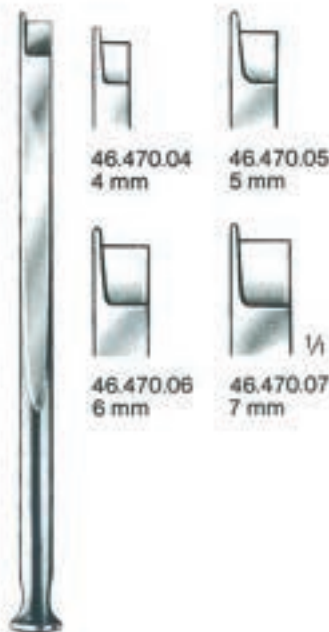

FOMON
46.470.04-46.470.07
17 cm

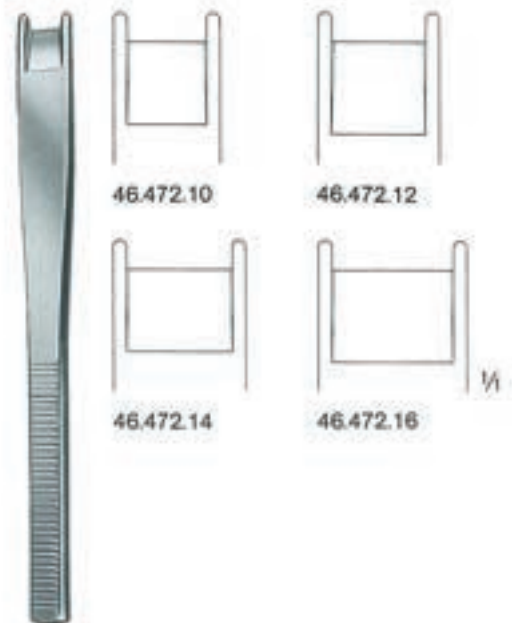

CINELLI
46.472.10-46.472.16

Rhinologie
Rhinology
Rhinologie
Rinologia
Rinologia



SILVER
46.473.01
18 cm

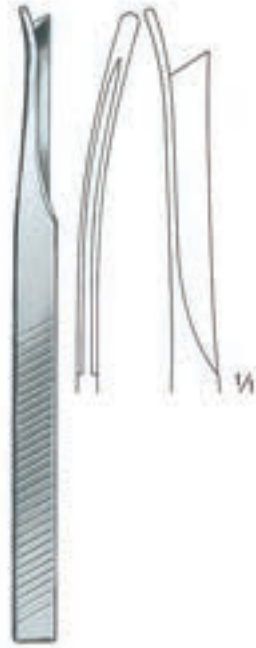

SILVER
46.473.02
18 cm



SILVER
46.473.03
18 cm



KILLIAN-CLAUS
46.482.05
17 cm/5 mm



mm	HAJEK
4	46.484.04
6	46.484.06
8	46.484.08



WEST
46.486.16
16 cm



WEST
46.487.16
16 cm



FREER
46.489.16
6 mm



JOSEPH
46.502.16
16 cm

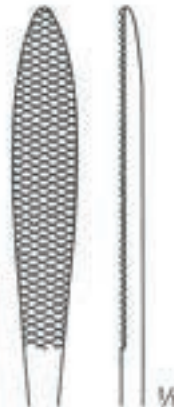

AUFRICHT
46.504.18
18 cm

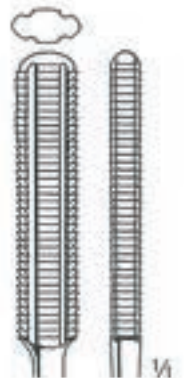

Rhinologie
Rhinology
Rhinologie
Rinología
Rinologia



LEWIS
46.507.18-46.507.19
18 cm



WIENER
46.511.21-46.513.21
21 cm



JOSEPH (LEWIS)
46.514.16-46.516.16
18 cm

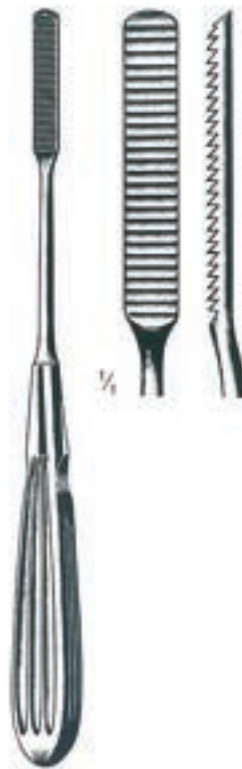

MALTZ (COTTLE)
46.518.21
21 cm



FOMON
46.520.21
21 cm

Rhinologie
Rhinology
Rhinologie
Rinologia
Rinologia



FOMON
20 cm TC

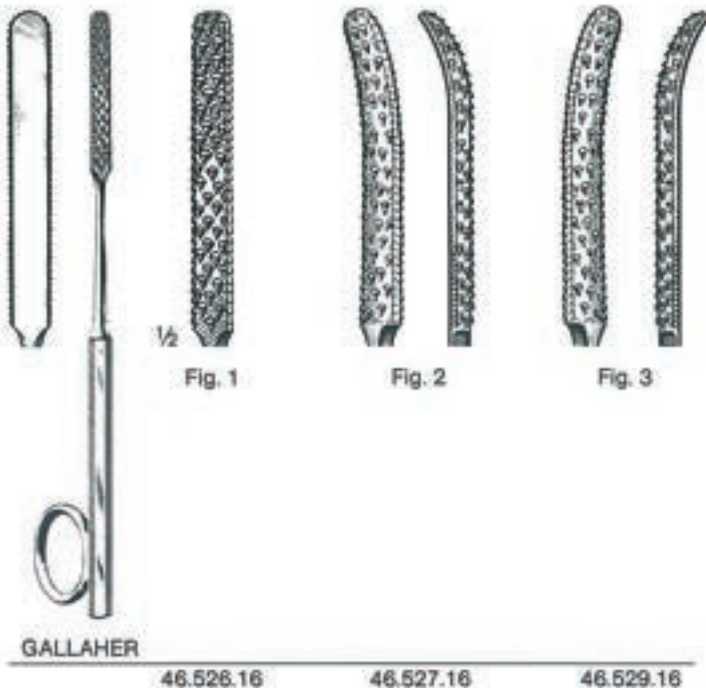
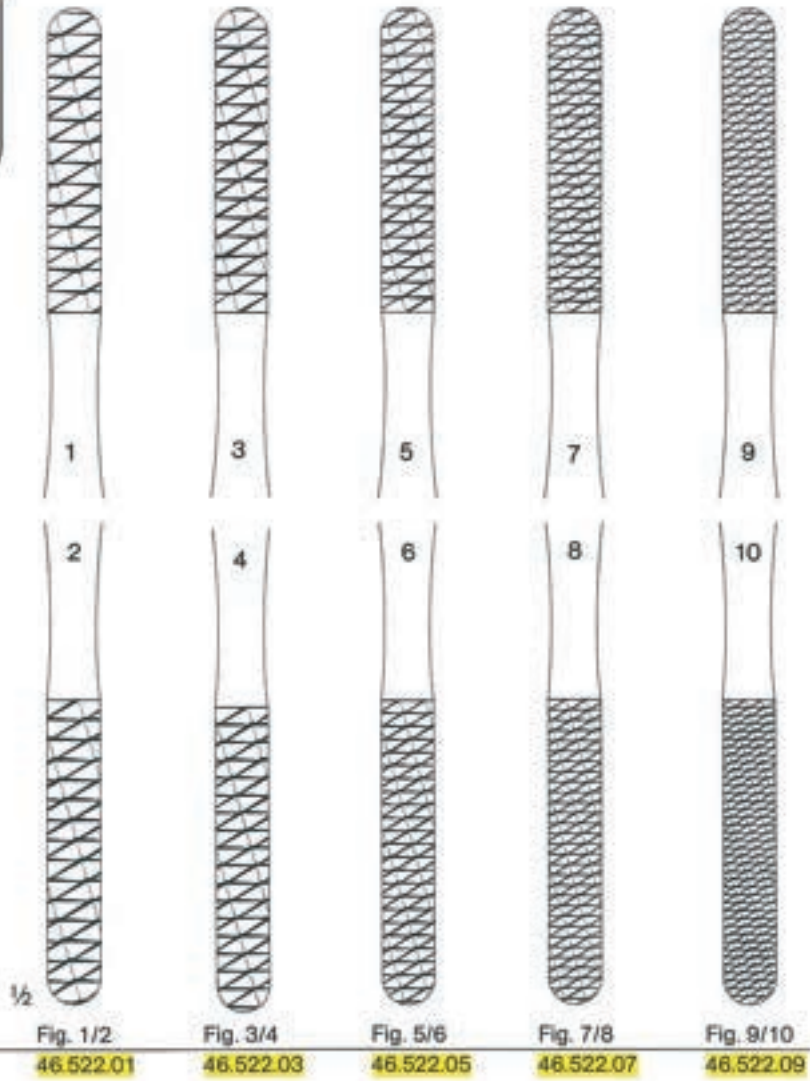

GALLAHER

46.526.16

46.527.16

46.529.16

Rhinologie
Rhynology
Rhinologie
Rinologia
Rinologia

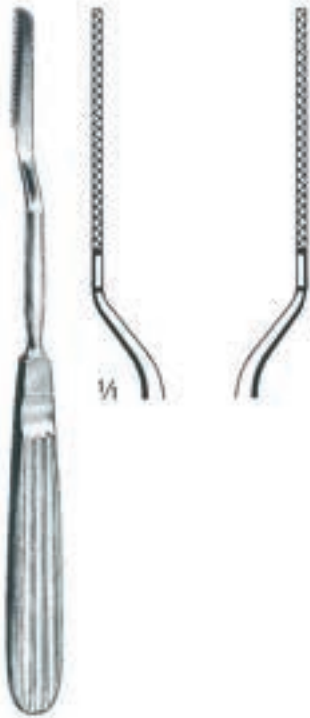

JOSEPH
19 cm 46.532.19 links · left · à gauche izquierda a sinistra
46.534.19 rechts · right · à droite derecha a destra



JOSEPH
46.535.01 17 cm 46.535.02



AUFRICHT
46.551.16
19 cm



COTTLE
46.556.14



FOMON
46.556.18



FOMON
46.557.17



COTTLE-NEIVERT
46.559.20



GILLIES
Fig. 1 46.560.18
Fig. 2 46.562.18
18 cm

Rhinologie
Rhynology
Rhinologie
Rinología
Rinologia

46



ASCH
46.571.23
23 cm



WALSHAM
46.572.23-46.575.23
23 cm



46.572.23
gerade
straight
droite
recta
retta



46.573.23
links
left
à gauche
izquierda
a sinistra



46.575.23
rechts
right
à droite
derecha
a destra



JATHO
46.595.15



FAULKNER
46.601.21
21 cm



46.607.01
Fig. 1



46.607.02
Fig. 2



46.607.03
Fig. 3

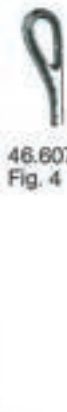

46.607.04
Fig. 4

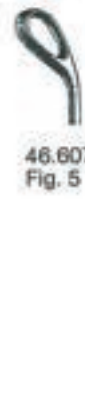

46.607.05
Fig. 5



46.607.06
Fig. 6

COAKLEY
46.607.01-46.607.06
17 cm

Rhinologie
Rhinology
Rhinologie
Rinologia
Rinologia



46.620.01
Fig. 1

46.620.02
Fig. 2



46.620.03
Fig. 3



46.620.04
Fig. 4



46.620.05
Fig. 5



46.620.06
Fig. 6

BECKMANN
46.620.01-46.620.06
22 cm



46.630.01
Fig. 1

46.630.02
Fig. 2



46.630.03
Fig. 3



46.630.04
Fig. 4

BARNHILL
46.630.01-46.630.04
21 cm

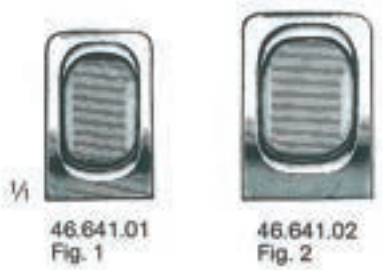

46.641.01
Fig. 1

46.641.02
Fig. 2



46.641.03
Fig. 3

Ersatzklingen, gelocht
Spare blades, perforated
Lames de rechange, perforées
Hojas de repuesto, perforadas
Lame di ricambio, forate

Fig.	
1	46.642.01
2	46.642.02
3	46.642.03

LAFORCE
46.641.01-46.641.03
25 cm



46.636.01
Fig. 1



46.636.03
Fig. 3



46.636.02
Fig. 2



46.636.04
Fig. 4

St. CLAIR-THOMSON
46.636.01-46.636.04
21 cm

Mund und Zunge
Mouth and Tongue
Bouche et langue
Boca y lengua
Bocca e lingua

Zungenspatel, Lippenhalter
Tongue Depressors, Lip Retractors
Abaisse-langue, écarteurs des lèvres
Abajalengua, Separadores de labios
Abbassalingua, Divaricatori di labbra



48.102.16
16 cm
Holz · wood ·
bois · madera · legno



FRENZEL
48.105.16
16,5 cm



BRUENINGS
48.107.19
19 cm



BUCHWALD
48.109.19
19 cm



HARTMANN
48.111.15
15 cm



48.115.01
Fig.1, 14 cm

48.115.02
Fig. 2, 15 cm

WIEDER
48.115.01-48.115.02



ANDREW
48.117.11
11 cm



TOBOLD
48.119.14
14,5 cm



cm	STERNBERG
14	48.227.14
16	48.227.16
18	48.227.18



cm	STERNBERG
12	48.229.12
14	48.229.14
16	48.229.16

Mund und Zunge
Mouth and Tongue
Bouche et langue
Boca y lengua
Bocca e lingua

Zungenzangen · Tongue Holding Forceps
Pinces tire-langue · Pinzas tiralengua
Pinze tiralingua



48.230.11
11 cm



48.235.19
19 cm



cm	COLLIN
16	48.250.16
18	48.250.18



48.255.99
Ersatz (Paar)
Spare (Pair)
Rechange (paire)
Repuesto (pareja)
Ricambio (coppia)

YOUNG
48.255.16
16 cm

Mundsperrer · Mouth Gags
Ouvre-bouche · Abrebocas
Apribocca



DOYEN-JANSEN (MOLT)
48.265.12
12 cm



DOYEN-JANSEN (MOLT)
48.265.14
14 cm



DENHART
48.267.12
12 cm



cm	ROSER-KOENIG
16	48.270.16
19	48.270.19



HEISTER
48.272.13
13 cm

Mund und Zunge
Mouth and Tongue
Bouche et langue
Boca y lengua
Bocca e lingua

Mundsperrer - Mouth Gags
Ouvre-bouche - Abrebocas
Apribocca



cm	JENNINGS
9	48.274.09
11	48.274.11
13	48.274.13
15	48.274.15



cm	WHITEHEAD
11	48.280.11
13	48.280.13
15	48.280.15



cm	WHITEHEAD
11	48.281.11
13	48.281.13
15	48.281.15



cm	SEEMANN-SEIFFERT
9	48.285.09
11	48.285.11
13	48.285.13
15	48.285.15



48.310.10

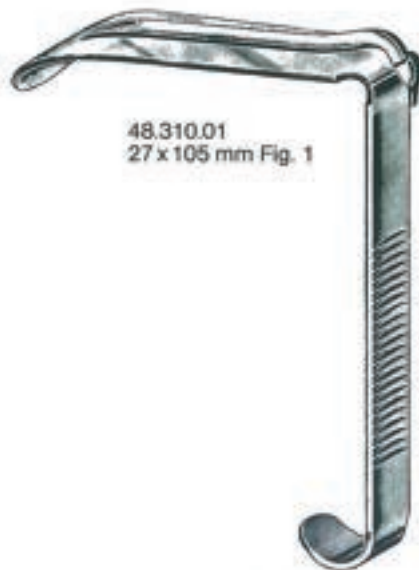

48.310.01
27 x 105 mm Fig. 1

DAVIS-BOYLE
48.310.00
compl.



48.310.02
25 x 90 mm Fig. 2



48.310.03
25 x 75 mm Fig. 3



48.310.04
22 x 60 mm Fig. 4



48.310.05
20 x 25 mm Fig. 5

Mundsperrer
Mouth Gags
Ouvre-bouche
Abrebocas
Apribocca

Mund und Zunge
Mouth and Tongue
Bouche et langue
Boca y lengua
Bocca e lingua



48.315.10



1/2
48.315.01
28 x 65 mm
Fig. 1



48.315.02
32 x 75 mm
Fig. 2



48.315.03
37 x 80 mm
Fig. 3



KILNER-DOUGHTY
48.315.00
compl.



48.320.10



48.320.01
27 x 95 mm
Fig. 1



1/2
48.320.02
22 x 85 mm
Fig. 2



48.320.03
22 x 70 mm
Fig. 3

McIVOR
48.320.00
compl.

48

Mund
Mouth
Bouche
Boca
Bocca



MAUNDER
48.360.10



PITHA
48.385.10

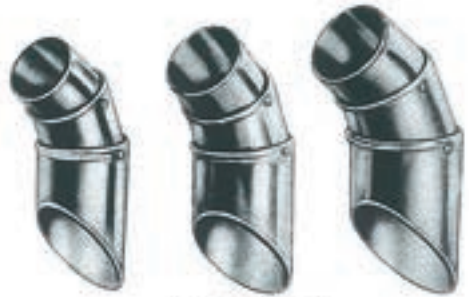

LANGENBECK
48.371.01 Fig. 1 48.371.02 Fig. 2 48.371.03 Fig. 3



links
left side
côté gauche
izquierda
lato sinistro

rechts
right side
côté droit
derecha
lato destro

cm	ROWE	ROWE	
22,5	48.501.22	48.503.22	Säugling · baby · bébé · bebé · lattante
23,5	48.501.23	48.503.23	Kinder · child · enfant · niño · bambino
24,0	48.501.24	48.503.24	Erwachsene · adult

Tonsillen
Tonsils
Amygdales
Amigdalas
Tonsille

50



mm	LOVE
18	50.103.18
20	50.103.20
22	50.103.22



HOFER
50.109.24
24 cm



NAGER
50.111.23
23 cm



HURD
50.131.22
glatt · smooth · lisse
liso · liscio
22 cm
50.133.22
gezahnt · serrated
dentelé · dentado
dentellato
22 cm



HENKE
50.135.23
23 cm



CARPENTER
50.139.25
25 cm



CARPENTER
50.143.24
24 cm



LUNIATSCHEK
50.151.19
19 cm



1/4

50

Tonsillen
Tonsils
Amygdales
Amigdalas
Tonsille

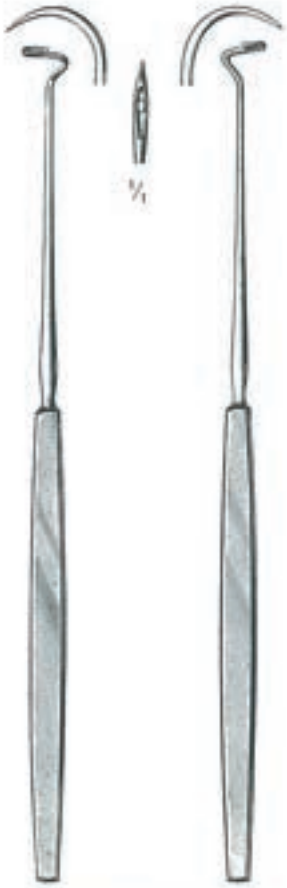

DUPUY-WEISS
50.185.22 50.167.22
22 cm

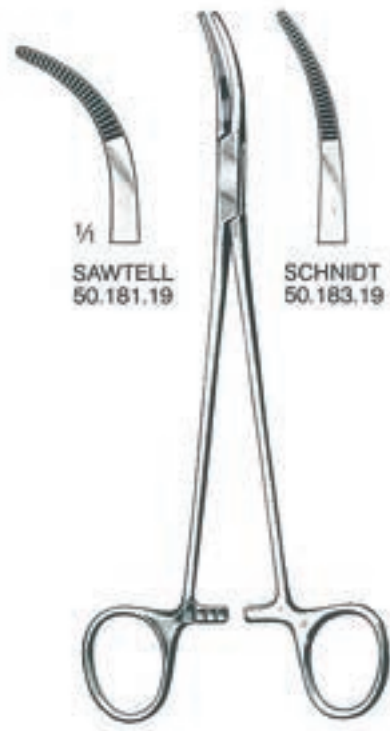

SAWTELL 50.181.19
SCHNIDT 50.183.19

50.181.19-50.183.19
19 cm

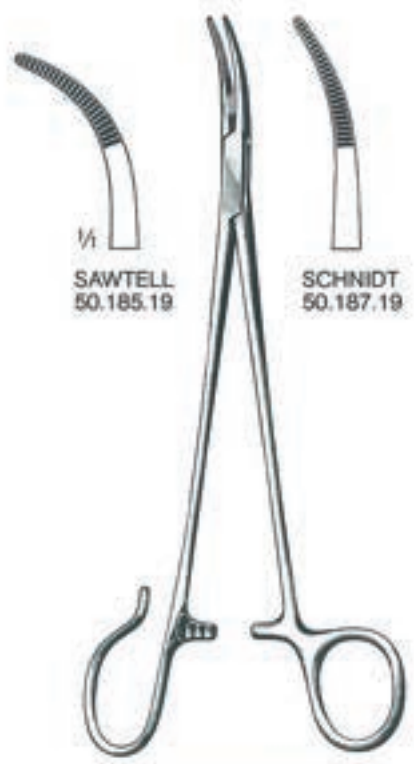

SAWTELL 50.185.19
SCHNIDT 50.187.19

50.185.19-50.187.19
19 cm



50.191.19 50.193.19

NEGUS
50.191.19-50.193.19
19 cm

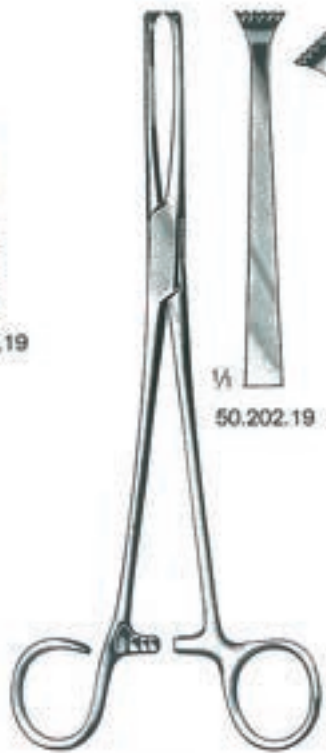

50.202.19 50.203.19

COLVER
50.202.19-50.203.19
19 cm

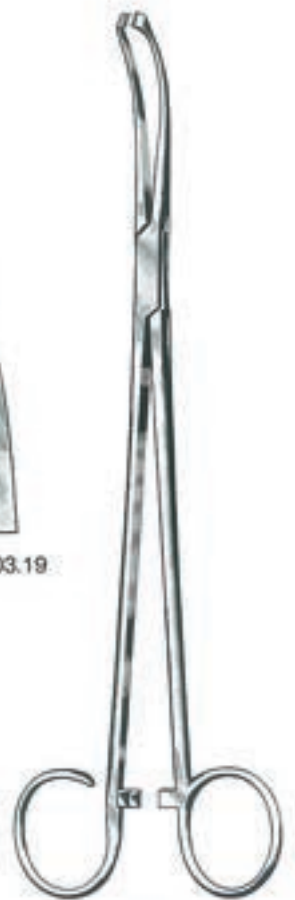

cm	WHITE
18	50.205.18
23	50.205.23

Tonsillen
Tonsils
Amygdales
Amigdalas
Tonsille

50



BALLENGER
50.207.21
21,5 cm



BLOHMKE
50.209.20
20 cm

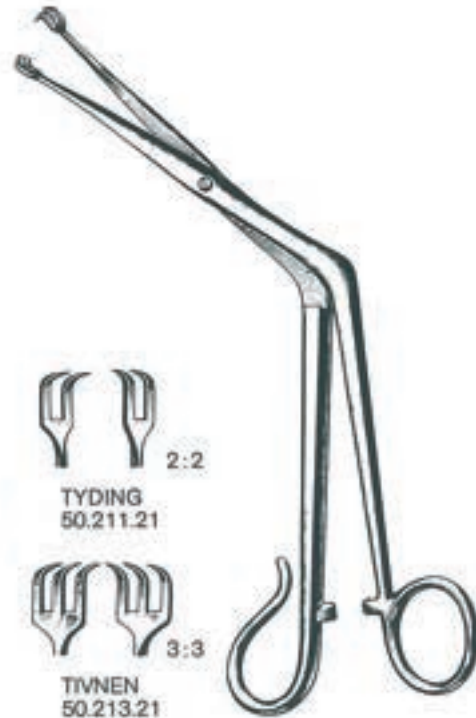

TYDING
50.211.21
2:2

TIVNEN
50.213.21
3:3

50.211.21-50.213.21
21 cm



MARSCHIK
50.219.22
22 cm



CORWIN
50.231.14
14 cm



EVES
50.250.28
28 cm



EVES
50.252.28
28 cm



BRUENINGS
50.256.28
28 cm



mm		50.259.03
40	50.257.40	0,3 mm
50	50.257.50	12 x
	100 x	

50

Tonsillen
Tonsils
Amygdales
Amigdalas
Tonsille



TYDING
50.260.00
mit 1 geraden Aufsatz
with 1 straight tip
à 1 embout droit
con 1 punta recta

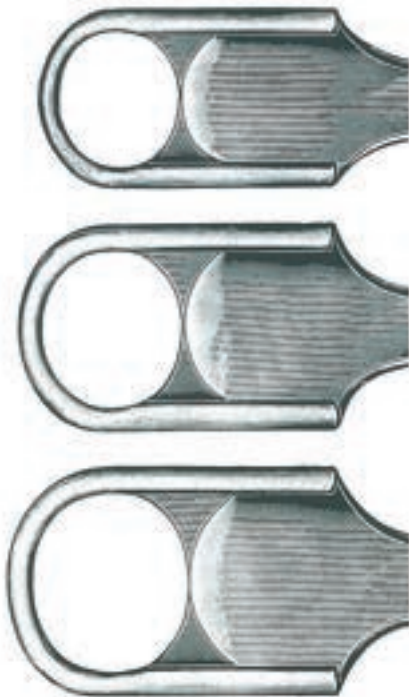

1/4



SLUDER-BALLENGER
50.270.00
mit 3 Aufsätzen
with 3 blades
avec 3 lames
con 3 hojas
con 3 lame



50.292.00



50.293.45
45°



50.293.90
90°

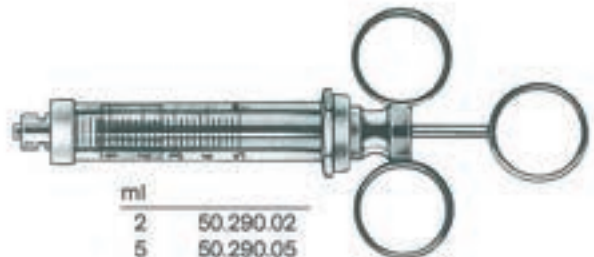

ml	
2	50.290.02
5	50.290.05
10	50.290.10

Kehlkopf
Larynx
Larynx
Laringe
Laringe



JACKSON
52.101.22-52.103.22
22 cm



FRAENKEL
52.111.18
18 cm

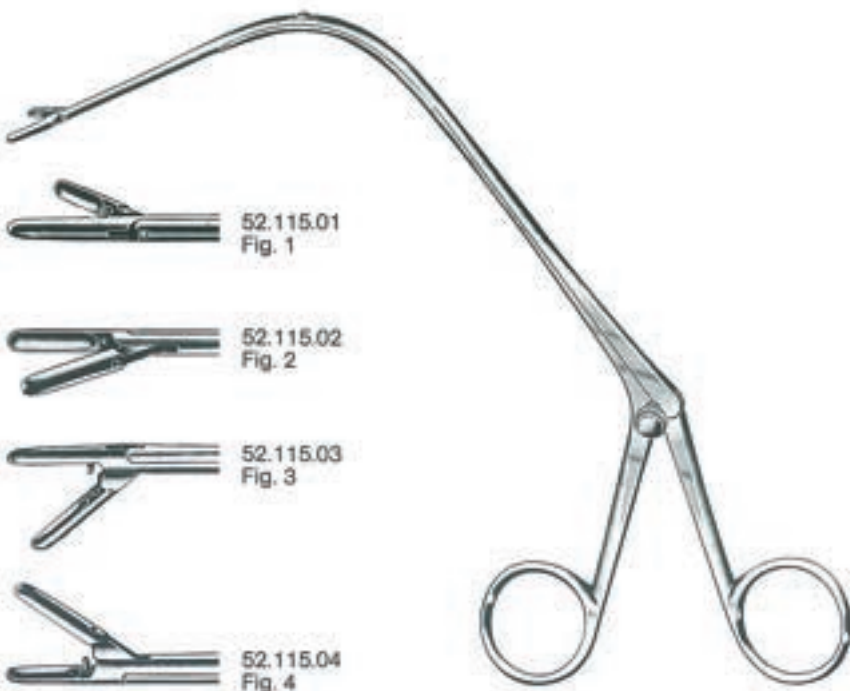

JURASZ
52.115.01-52.115.04
23 cm



REICHERT
52.121.24
24 cm

52

Kehlkopf
Larynx
Larynx
Larynx
Larynx



HUBER
52.130.00



cm BRUENINGS

20	52.132.20
30	52.132.30
40	52.132.40
50	52.132.50
60	52.132.60

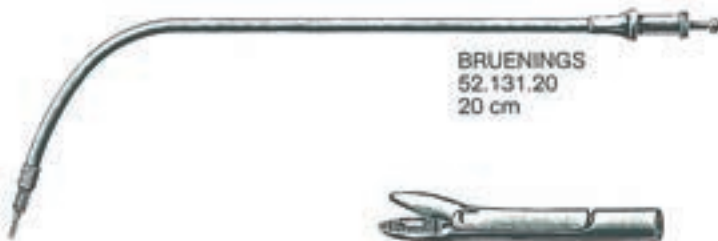

BRUENINGS
52.131.20
20 cm



FRAENKEL
52.150.00



SEIFFERT
52.152.00



FRAENKEL
52.154.00



SCHEINMANN
52.155.00



SCHEINMANN
52.157.00



52.158.02
52.158.03
BRUENINGS
52.158.02-52.158.03



52.160.02
52.160.03
BRUENINGS
52.160.02-52.160.03



LANGE
52.162.00

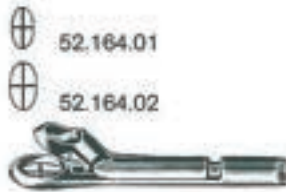

52.164.01
52.164.02
KRAUSE
52.164.01-52.164.02



KRAUSE
52.166.00

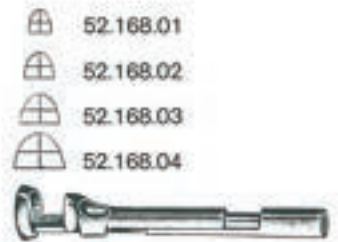

52.168.01
52.168.02
52.168.03
52.168.04
CORDES
52.168.01-52.168.04



SCHUMACHER
52.170.00



52.172.01
52.172.02
CORDES
52.172.01-52.172.02



CORDES
52.174.00



ROSENBERG
52.176.00

Kehlkopf
Larynx
Larynx
Laringe
Laringe



CHEVALIER-JACKSON
52.230.01-52.260.07

cm	Fig. 1	Fig. 2	Fig. 3	Fig. 4	Fig. 5	Fig. 6	Fig. 7
30	52.230.01	52.230.02	52.230.03	52.230.04	52.230.05	52.230.06	52.230.07
40	52.240.01	52.240.02	52.240.03	52.240.04	52.240.05	52.240.06	52.240.07
50	52.250.01	52.250.02	52.250.03	52.250.04	52.250.05	52.250.06	52.250.07
60	52.260.01	52.260.02	52.260.03	52.260.04	52.260.05	52.260.06	52.260.07



52.270.08-52.270.30



	Fig.	mm Ø	
52.270.08	00	8	52.272.08
52.270.10	0	10	52.272.10
52.270.12	1	12	52.272.12
52.270.14	2	14	52.272.14
52.270.16	3	16	52.272.16
52.270.18	4	18	52.272.18
52.270.20	5	20	52.272.20
52.270.22	6	22	52.272.22
52.270.24	7	24	52.272.24
52.270.26	8	26	52.272.26
52.270.28	9	28	52.272.28
52.270.30	10	30	52.272.30



52.272.08-52.272.30



52.274.12



52.276.10

Gastroskopie
Gastroskopy
Gastroscope
Gastroscofia
Gastroscofia

Flexible Zangen
Flexible Forceps
Pinces flexibles
Pinzas flexibles
Pinze flessibili

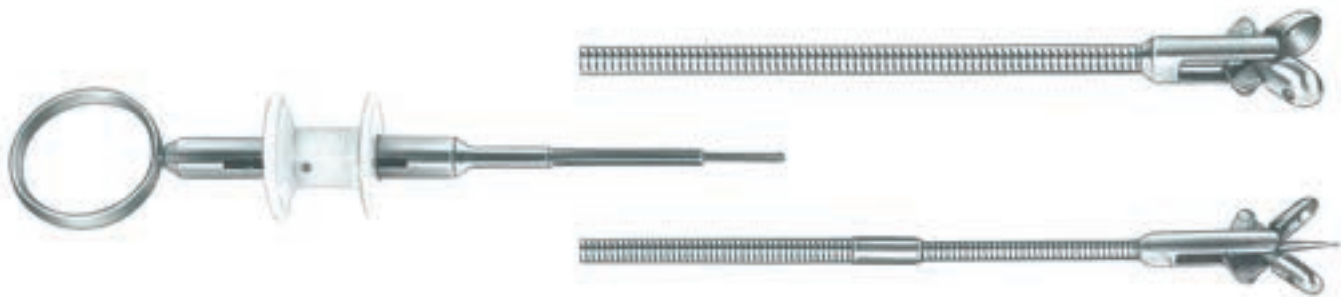

	Ø 1,8 mm	Ø 2,2 mm	Ø 2,6 mm	Ø 3,4 mm
L cm				
160	53.110.16	53.120.16	53.130.16	53.140.16
160	53.110.26	53.120.26		
230	53.110.23	53.120.23	53.130.23	53.140.23
230	53.110.33	53.120.33		

L cm				
160	53.111.16	53.121.16	53.131.16	53.141.16
160	53.111.26	53.121.26		
230	53.111.23	53.121.23	53.131.23	53.141.23
230	53.111.33	53.121.33		

L cm			
160	53.112.16	53.122.16	53.142.16
160	53.112.26	53.122.26	
230	53.112.23	53.122.23	53.142.23
230	53.112.33	53.122.33	

L cm			
160	53.113.16	53.123.16	53.143.16
160	53.113.26	53.123.26	
230	53.113.23	53.123.23	53.143.23
230	53.113.33	53.123.33	

Flexible Zangen, isoliert
Flexible Forceps, insulated
Pinces flexibles isolées
Pinzas flexibles aisladas
Pinze flessibili isolate

Gastroskopie
Gastroscopy
GastroscoPie
GastroscoPia
Gastroscopia

53



Ø 1,8 mm

Ø 2,2 mm

Ø 2,6 mm

Ø 3,4 mm



L cm

160 53.212.16
230 53.212.23

53.222.16
53.222.23

53.232.16
53.232.23

53.242.16
53.242.23

Gastroskopie
Gastroskopy
Gastroscofie
Gastroscofia
Gastroscofia

Ø 2,2 mm

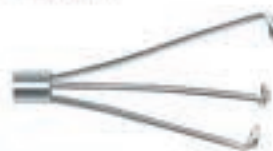

Flexible Zangen
Flexible Forceps
Pinces flexibles
Pinzas flexibles
Pinze flessibili

L cm	
160	53.291.16
230	53.291.23

Ø 1,8 mm



L cm	
160	53.292.16
230	53.292.23

verlängert - tapered



		L cm	
53.301.26	53.301.16	160	53.341.16
53.301.33	53.301.23	230	53.341.23



		L cm	
53.302.26	53.302.16	160	53.342.16
53.302.33	53.302.23	230	53.342.23



L cm	
160	53.343.16
230	53.343.23



		L cm	
53.304.16		160	53.344.16
53.304.23		230	53.344.23



		L cm	
53.311.16		160	53.351.16
53.311.23		230	53.351.23



		L cm	
53.312.16		160	53.352.16
53.312.23		230	53.352.23



		L cm	
53.313.16		160	53.353.16
53.313.23		230	53.353.23



		L cm	
53.314.16		160	53.354.16
53.314.23		230	53.354.23



Tracheotomie
Tracheostomy
Trachéotomie
Traqueotomía
Tracheotomia

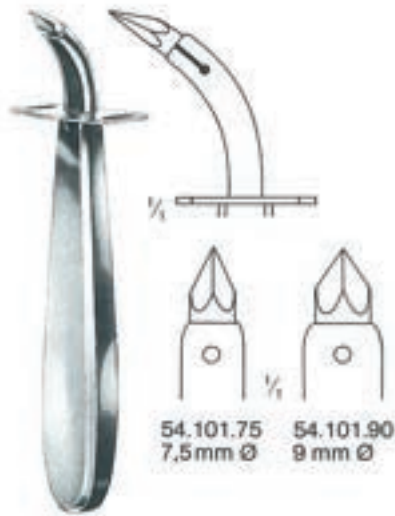

UCKERMANN
54.101.75-54.101.90
13 cm

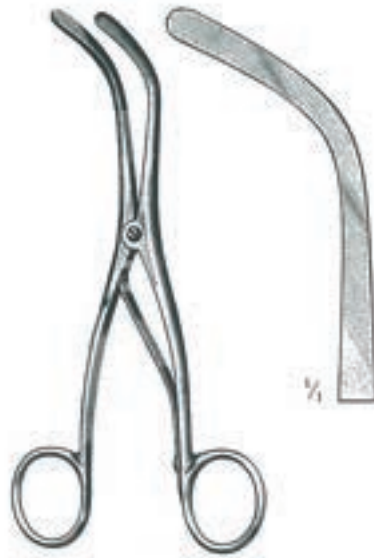

TROUSSEAU
54.111.14
14 cm



LABORDE
54.113.14
14 cm



BOSE
54.115.07
7 cm



JACKSON
54.116.15
15 cm



JACKSON
54.117.17
17 cm



ITERSON
54.118.16-54.119.16
16 cm



BOSE
54.122.16
16 cm



BOSE
54.124.16
16 cm

Tracheotomie
Tracheostomy
Trachéotomie
Traqueotomía
Tracheotomia



ROSE
54.130.13
13 cm



mm	WAGENER-MOSHER
5	54.151.05
7	54.151.07
9	54.151.09



54.270.00



Fig.	mm	LUER
0	4	54.220.04
1	5	54.220.05
2	6	54.220.06
3	7	54.220.07
4	8	54.220.08
5	9	54.220.09
6	10	54.220.10
7	11	54.220.11
8	12	54.220.12
9	13	54.220.13



Fig.	mm	JACKSON
0	4	54.240.04
1	5	54.240.05
2	6	54.240.06
3	7	54.240.07
4	8	54.240.08
5	9	54.240.09
6	10	54.240.10
7	11	54.240.11
8	12	54.240.12
9	13	54.240.13

Kropf
Goitre
Goitre
Bocio
Gozzo



KOCHER
54.501.15-54.503.15
15 cm



SCHOENBORN
54.511.21
21 cm



cm	LAHEY
15	54.520.15
20	54.520.20



MASTIN
54.523.17
17 cm

56

Thorax
Thorax
Thorax
Tórax
Torace

Rippenscheren
Rib Shears
Costotomes
Costótomos
Costotomi



56.102.23
23 cm



56.105.22
22 cm



GLUCK
56.107.22
22 cm



STILLE
56.111.21
21 cm

Rippenscheren
Rib Shears
Costotomes
Costótomos
Costotomi

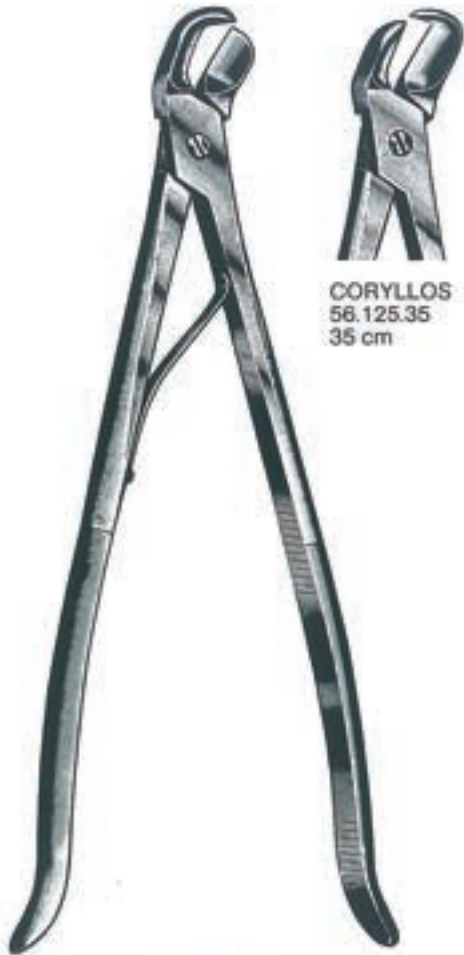

CORYLLOS
56.125.35
35 cm



BETHUNE
56.126.34
34 cm



SAUERBRUCH
56.131.26



GIERTZ-STILLE
56.137.27
27 cm



SAUERBRUCH-FREY
56.141.36
36 cm

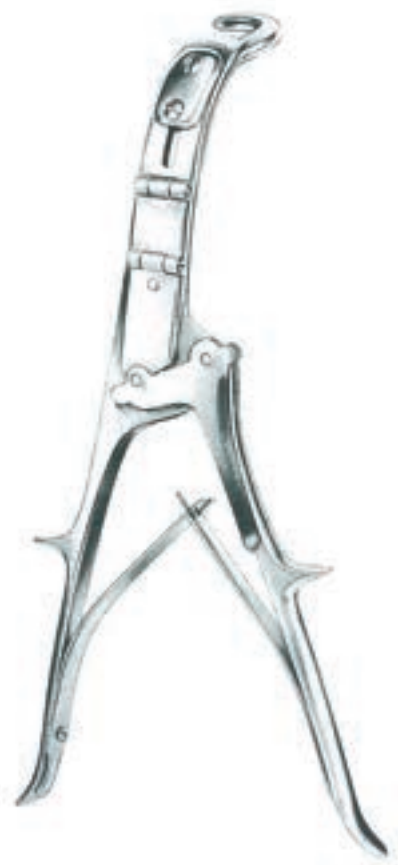

BRUNNER
56.147.28
28 cm

Thorax
Thorax
Thorax
Tórax
Torace

56

Rippensperrer
Rib Spreaders
Ecarteurs des côtes
Separadores costales
Divaricatori costali

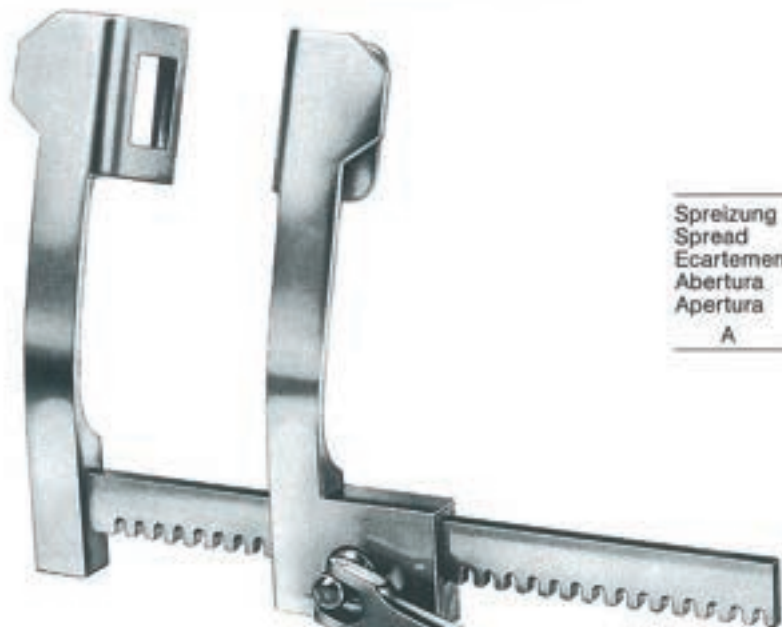

Blatt - Blade - valve
hoja - valva

Spreizung Spread Ecartement Abertura Apertura	Tiefe Depth profondité profundidad profondità	Breite Width largeur ancho larghezza
A	B	C



FINOCHIETTO	A = mm	B = mm	C = mm
56.210.16	165	40	40
56.210.20	200	45	55
56.210.25	250	70	65



FINOCHIETTO-Baby	A = mm	B = mm	C = mm
56.214.75	75	18	20

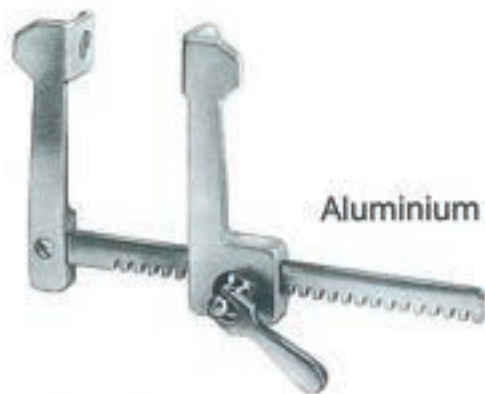

FINOCHIETTO-Infant	A = mm	B = mm	C = mm
56.234.75	75	15	15

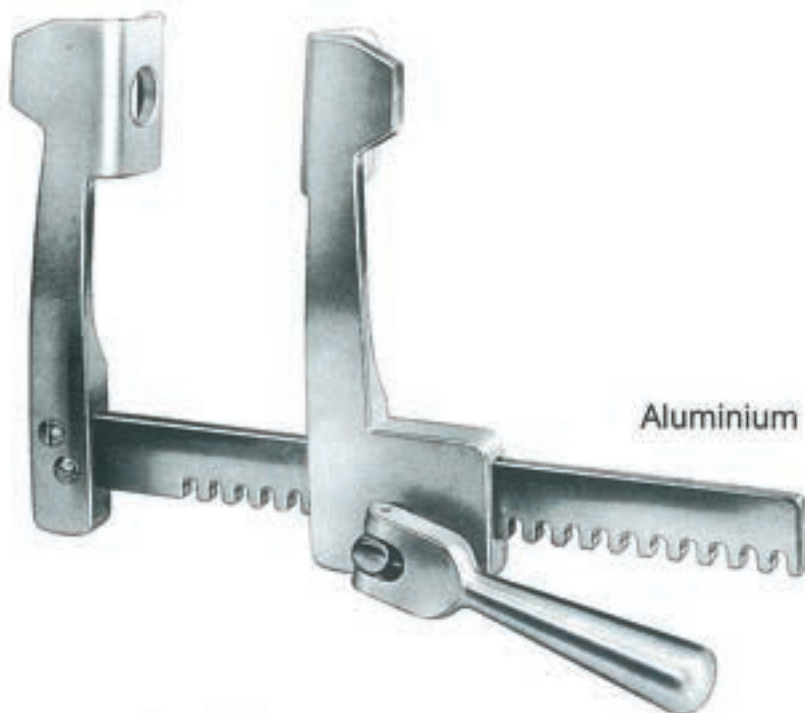

FINOCHIETTO	A = mm	B = mm	C = mm
56.230.13	135	38	44
56.230.17	175	52	62
56.230.18	175	85	65

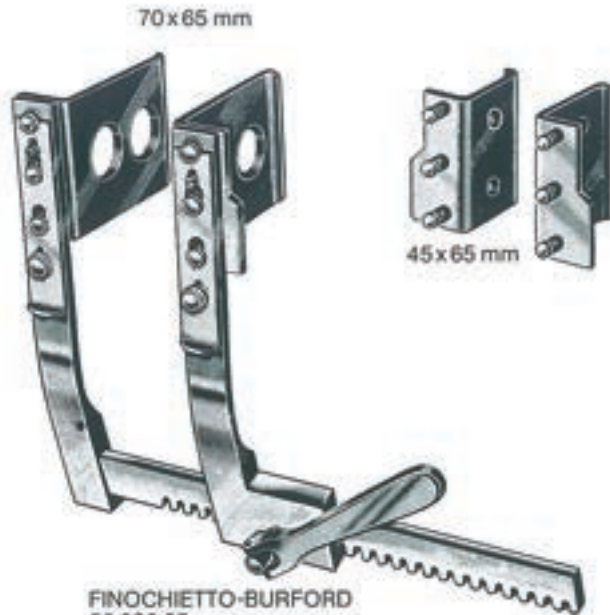

FINOCHIETTO-BURFORD
56.236.25
25 cm

Rippensperrer
Rib Spreaders
Ecarteurs des côtes
Separadores costales
Divaricatori costali



FINOCHIETTO-BURFORD
56.242.18 180 mm
56.242.26 260 mm
56.242.30 300 mm

Aluminium

Für Erwachsene
Adult Size
pour adultes
para adultos
per adulti



FINOCHIETTO-BURFORD
56.244.13
135 mm

Aluminium

Für Kinder
Child Size
pour enfants
para niños
per bambini

Rippensperrer
Rib Spreaders
Ecarteurs des côtes
Separadores costales
Divaricatori costali

Blatt · Blade · Valve
 Hoja · Valva

Spreizung
 Spread
 Ecartement
 Abertura
 Apertura

Tiefe
 Depth
 profondeur
 profundidad
 profondità

Breite
 Width
 largeur
 ancho
 larghezza

A

B

C

Aluminium



56.250.06



56.250.07



56.250.12

CASTAÑEDA	A = mm	B = mm	C = mm
56.250.06	65	10,5	32
56.250.07	70	12	45
56.250.12	120	15	60



HAIGHT	A = mm	B = mm	C = mm
56.260.09	90	30	30



TUFFIER	A = mm	B = mm	C = mm
58.264.16	165	50	45

Thorax
Thorax
Thorax
Tórax
Torace

56

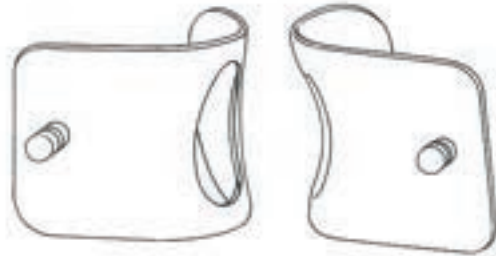

75x75 mm



42x85 mm

»Mercedes« compl.
56.270.00



SELLORS
56.280.19



BAILEY-Baby
56.282.14



BAILEY
56.284.16



BAILEY-GIBBON
56.286.16



ALLISON
56.289.32
32 cm

Lunge
Lung
Poumon
Pulmón
Polmone

Bronchus-Klemmen · Bronchus Forceps · Pincers
clamps pour les bronches · Pinzas clamps
bronquiales · Pinze per bronchi

Lungenfaßzangen
Lung Grasping Forceps
Pincers à saisir le poumon
Pinzas para coger el pulmón
Pinze per afferrare il polmone



LOVELACE
56.290.20
20 cm

LOVELACE
56.291.20
20 cm



HARRINGTON
56.301.30
30,5 cm

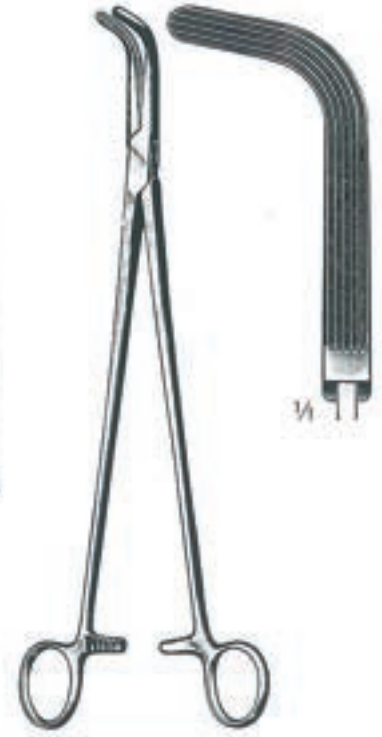

HARRINGTON
56.303.29
29,5 cm



FINOCCHIETTO
56.307.24
24 cm



PRICE-THOMAS
56.309.22
22 cm



links
left
à gauche
izquierda
sinistra

56.311.22

rechts
right
à droite
destra

PRICE-THOMAS
22 cm

56.313.22

Bronchus-Klemmen · Bronchus Forceps · Pincas
clamps pour les bronches · Pinzas clamps
bronquiales · Pinze per bronchi

Lunge
Lung
Poumon
Pulmón
Polmone



Zahn links
tooth left
dent à gauche
diente a la izquierda
dente sinistro

SAROT

56.317.23

23 cm

Zahn rechts
tooth right
dent à droite
diente a la derecha
dente destro

56.319.23

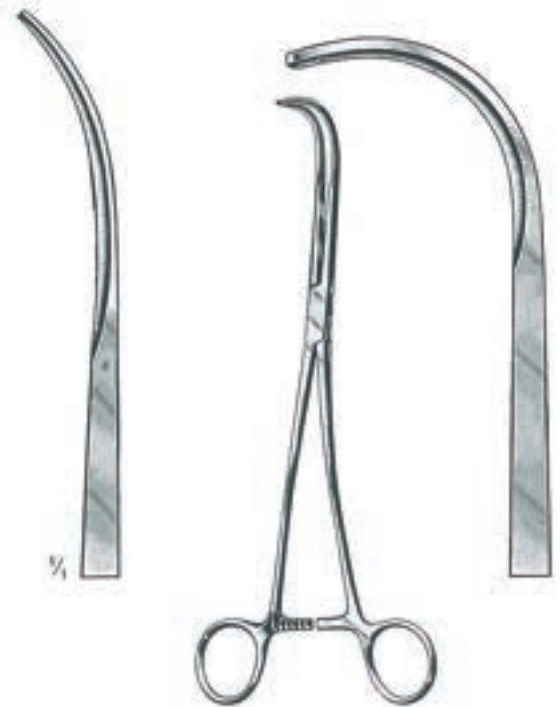

1/4

SEMB

56.321.23

23 cm

56.323.23

Anastomosen-Klemmen
Anastomosis Clamps
Pincas à anastomose
Pinzas para anastomosis
Pinze per anastomosi



SATINSKY
56.325.15
15 cm



SATINSKY
56.327.26-56.329.26
26 cm



1/4

56.327.26
Fig. 1

56.329.26
Fig. 2

62

Galle
Gall Bladder
Voies biliaires
Vesicula biliar
Vescicola biliare



DESJARDINS
62.101.23-62.103.23
23 cm

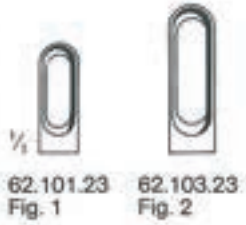

62.101.23 Fig. 1
62.103.23 Fig. 2



BLAKE
62.106.20 20 cm 62.107.20



MAYO BLAKE
62.110.20
20 cm



MAYO-BLAKE
62.111.20
20 cm



MIXER
62.117.22
22 cm



MOORE
62.125.28



OCHSNER
62.128.35

Galle
Gall Bladder
Voies biliaires
Vesícula biliar
Vescicola biliare

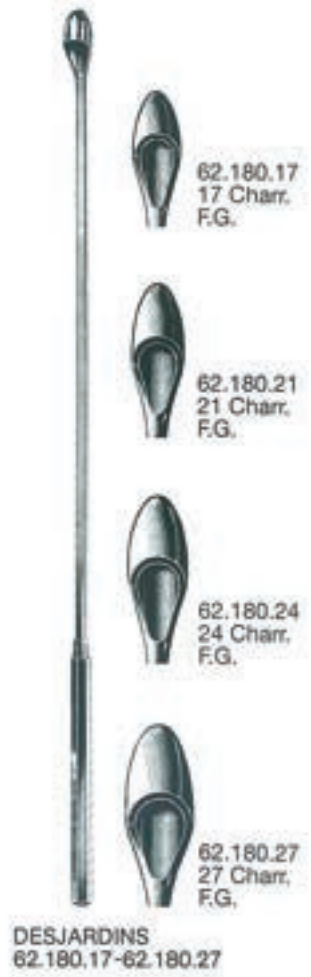
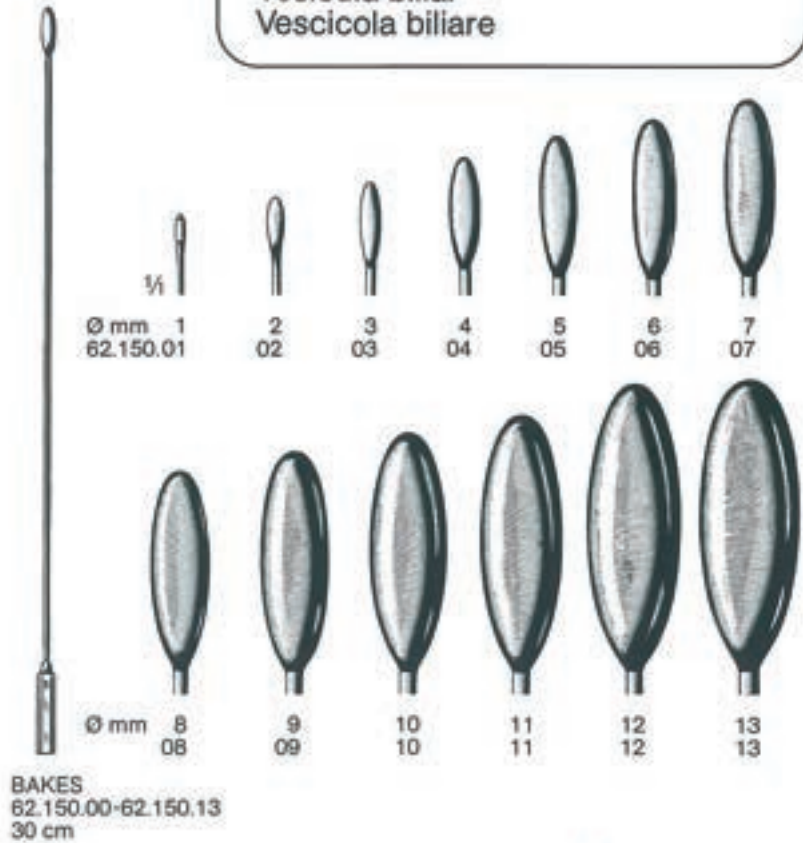

64

Niere
Kidney
Rein
Riñon
Rene



MAYO
62.210.32
32 cm



LURZ
62.221.21
21 cm

Ureterklemmen
Ureter Clamps
Pincas-clamps à uretère
Pinzas clamps para ureter
Pinze per uretere

LURZ
62.223.21
21 cm



Nierensteinzangen
Kidney Stone Forceps
Pincas à calculs renaux
Pinzas para cálculos renales
Pinze per calcoli renali

RANDALL	Fig.	cm
62.231.01	1	23
62.231.02	2	22
62.231.03	3	22
62.231.04	4	22
62.231.05	5	19
62.231.06	6	19

RANDALL
62.231.01-62.231.06

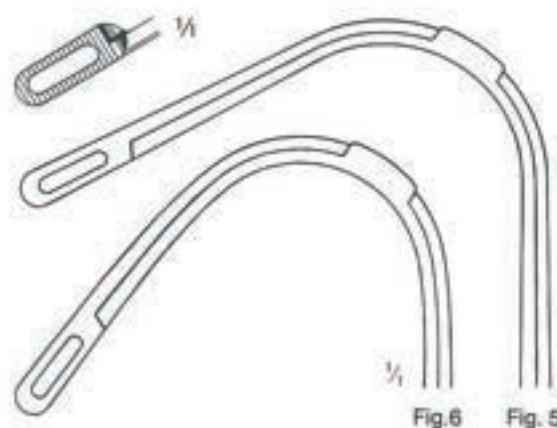

Fig. 6 Fig. 5

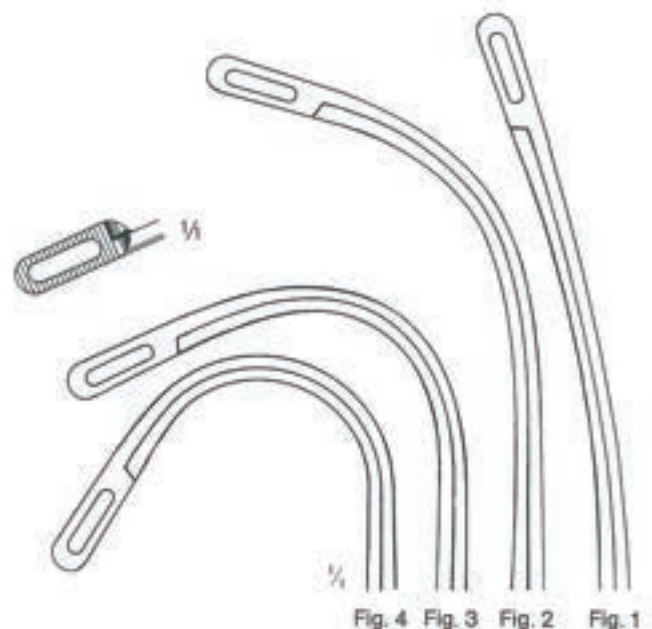
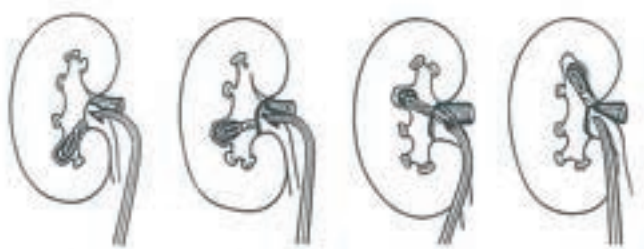

Fig. 4 Fig. 3 Fig. 2 Fig. 1

in situ:



5-6



4 3 2 1

Darm- und Gewebefaßzangen
Bowel and Tissue Grasping Forceps
Pincés à saisir les intestins et les tissus
Pinzas para coger intestinos y tejidos
Pinze per afferrare intestini e tessuti

Darm, Magen
Intestines and Stomach
Intestin, Estomac
Intestines, Estómago
Intestini, Stomaco

64



ALLIS-Baby
64.102.14
14 cm



4:5	ALLIS	5:6
64.110.15	15 cm	64.120.15
	19 cm	64.120.19
	22 cm	64.120.22
	24 cm	64.120.24



atraumatisch
atraumatic
atraumatique
atraumática
atraumatica

cm	ALLIS
16	64.124.16
20	64.124.20
25	64.124.25



ALLIS-ADAIR
64.130.15
15,5 cm



cm	JUDD-ALLIS
15	64.140.15
19	64.140.19



THOMS-ALLIS
64.150.20
20 cm

Mit TC-Einsätzen
TC Lined
A mors TC
Con bocas TC
Con morso TC



atraumatisch
atraumatic
atraumatique
atraumática
atraumatica

cm	BABCOCK	TC	
16	64.160.16	64.164.16	64.168.16
18	64.160.18		
20	64.160.20	64.164.20	64.168.20
24	64.160.24		

Darm, Magen
Intestines and Stomach
Intestin, Estomac
Intestines, Estómago
Intestini, Stomaco

Mit TC-Einsätzen
TC Lined
A mors TC
Con bocas TC
Con morso TC



DUVAL
13 mm



DUVAL
25 mm

cm	DUVAL 13 mm	DUVAL 25 mm
18	64.170.18	
20	64.170.20	64.172.20
20	64.174.20	
23		64.172.23



DUVAL
64.170.18-64.174.20



WILLIAMS
64.180.16
16,5 cm



SCHOENBURG
64.182.22
22 cm

Darmklemmen
Intestinal Forceps
Pinces intestinales
Pinzas intestinales
Pinze intestinali



DOYEN
DOYEN-Baby
64.210.18-64.217.23



cm	DOYEN-Baby
16	
18	64.210.18 64.211.18
21	
23	



cm	DOYEN
16	
18	
21	64.210.21 64.211.21
23	64.210.23 64.211.23



atraumatisch
atraumatic
atraumatiques
atraumáticas
atraumatiche

cm	DOYEN
16	64.216.16 64.217.16
18	64.216.18 64.217.18
21	64.216.21 64.217.21
23	64.216.23 64.217.23

Darmklemmen
Intestinal Forceps
Pinces intestinales
Pinzas intestinales
Pinze intestinali

Darm, Magen
Intestines and Stomach
Intestin, Estomac
Intestines, Estómago
Intestini, Stomaco



KOCHER
64.220.22-64.227.28

cm	KOCHER			
22	64.220.22	64.221.22	64.226.22	64.227.22
25	64.220.25	64.221.25	64.226.25	64.227.25
28	64.220.28	64.221.28	64.226.28	64.227.28

atraumatisch
atraumatic
atraumatiques
atraumáticas
atraumatiche

64

Darm, Magen
Intestines and Stomach
Intestin, Estomac
Intestines, Estómago
Intestini, Stomaco

Darmklemmen
Intestinal Forceps
Pinces intestinales
Pinzas intestinales
Pinze intestinali

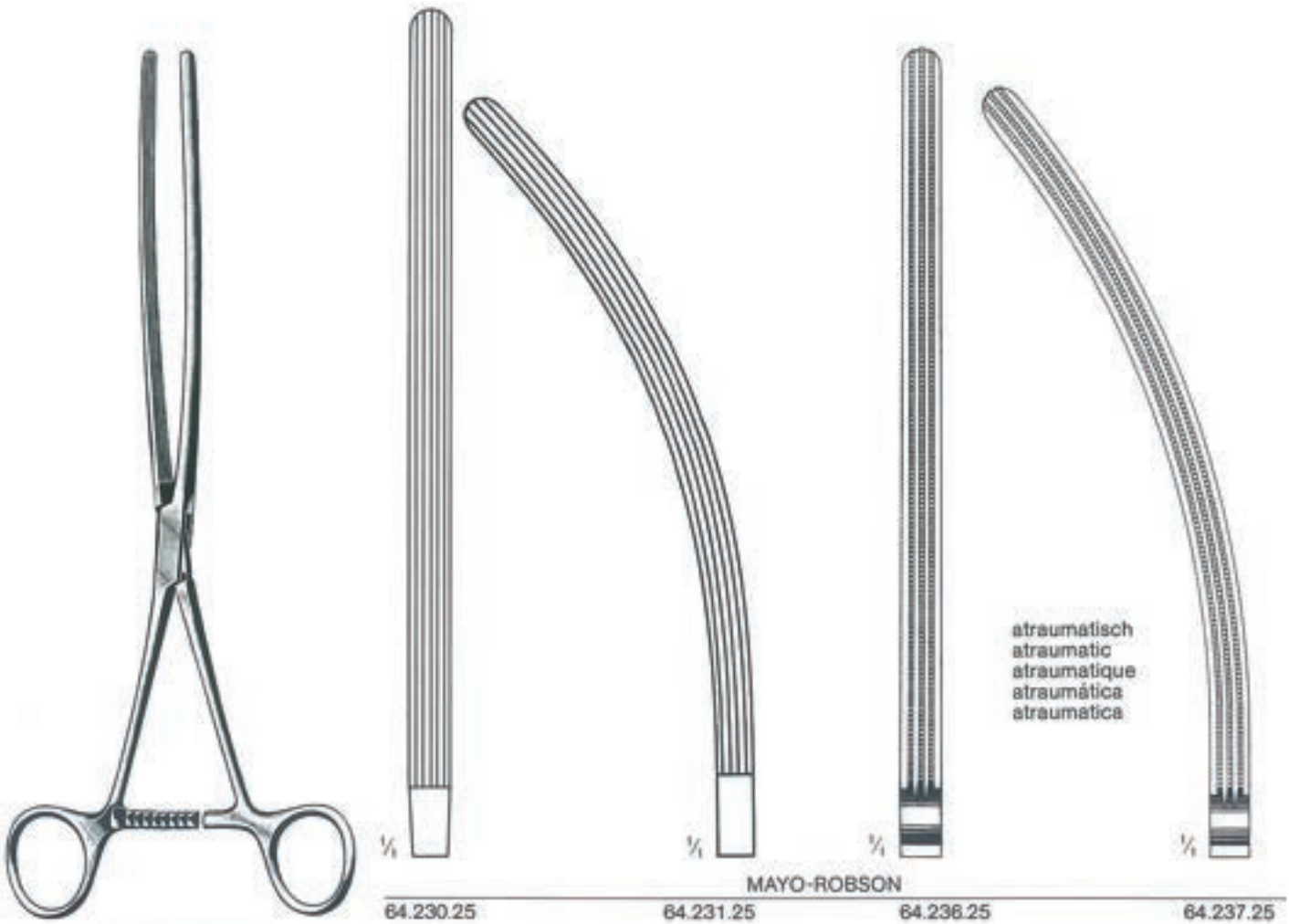

MAYO-ROBSON
64.230.25-64.237.25
25 cm

64.230.25 64.231.25 64.236.25 64.237.25



normal	FEHLAND	atraum.
64.241.23	23,5 cm	64.247.23

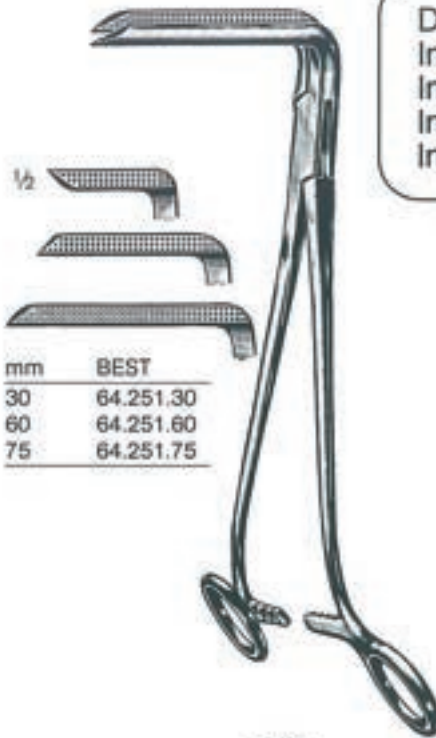

mm	BEST
30	64.251.30
60	64.251.60
75	64.251.75

BEST
64.251.30-64.251.75
26,5 cm

Darm, Magen
Intestines and Stomach
Intestin, Estomac
Intestines, Estómago
Intestini, Stomaco

Darm- und Magenklappen
Intestinal and Stomach Clamps
Pinzas-clamps intestinales
Pinzas-clamps intestinales y estomacales
Pinze intestinali e stomacali



BRUNNER
64.260.24-64.266.24
24 cm



BRUNNER
64.260.24 64.266.24

atraumatisch
atraumatic
atraumatique
atraumática
atraumatica



STONE
64.270.15
15,5 cm



STONE-WATT
64.274.00



cm	STONE-WATT
7,5	64.272.07
10	64.272.10

Darm, Magen
Intestines and Stomach
Intestin, Estomac
Intestines, Estómago
Intestini, Stomaco

Anastomosenklemmen und Zubehör
Anastomosis Clamps and Accessories
Clamps à anastomose et accessoires
Clamps para anastomosis y accesorios
Pinze per anastomosi e accessori

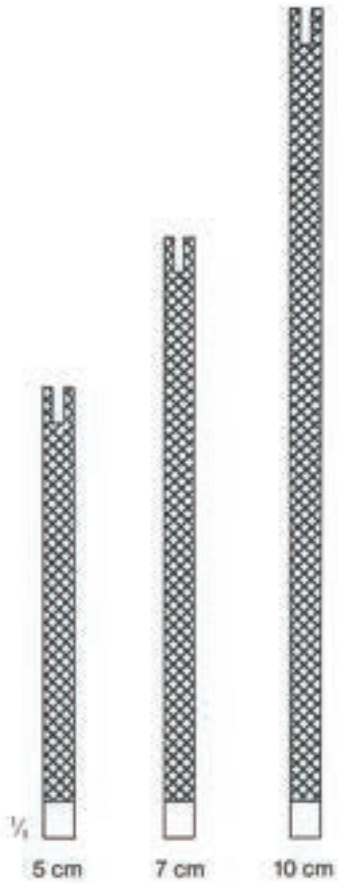

cm	DE MARTEL-WOLFSON
5	64.280.05
7	64.280.07
10	64.280.10
Set/3	



DE MARTEL-WOLFSON
64.282.26
26 cm

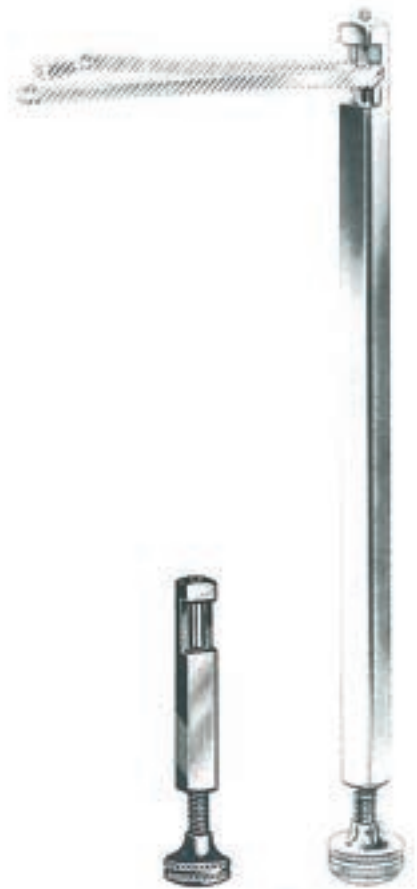

DE MARTEL-WOLFSON
64.284.08 64.284.23
8,5 cm 23 cm

Magenklemmen
Stomach Clamps
Pincas-clamps stomacales
Pinzas-clamps estomacales
Pinze stomacali

Darm, Magen
Intestines and Stomach
Intestin, Estomac
Intestines, Estómago
Intestini, Stomaco

64



LANE
64.290.30
30 cm



LANE
64.291.30
30 cm

Darm, Magen
Intestines and Stomach
Intestin, Estomac
Intestines, Estómago
Intestini, Stomaco

Magenklemmen
Stomach Clamps
Pinces-clamps stomacales
Pinzas-clamps estomacales
Pinze stomacali

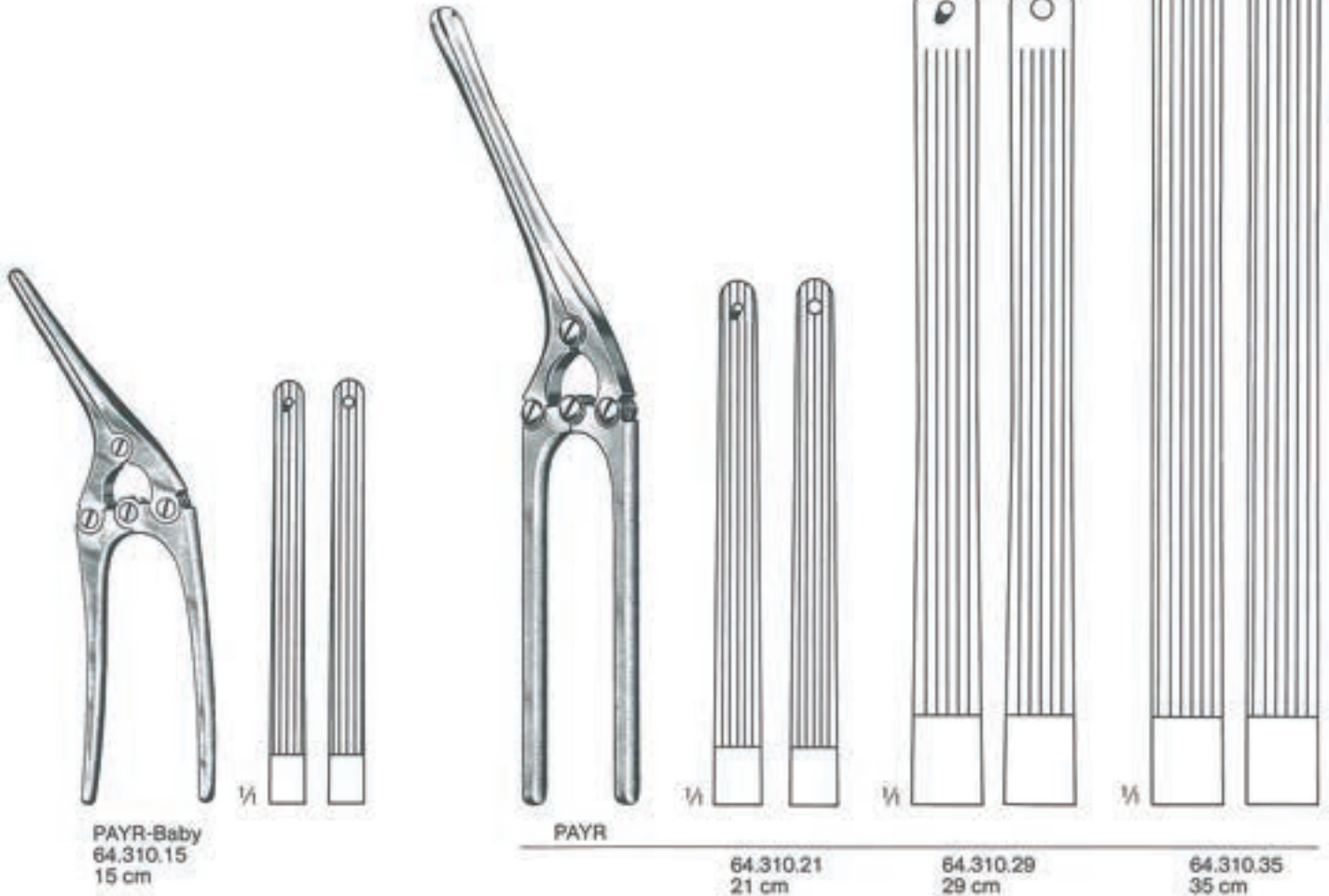

Magen- und Darmnähhapparat · Stomach and Intestinal Suturing Apparatus · Appareil à suture stomacales et intestinales · Aparato para suturas estomacales e intestinales · Apparecchio per suture stomacali e intestinali

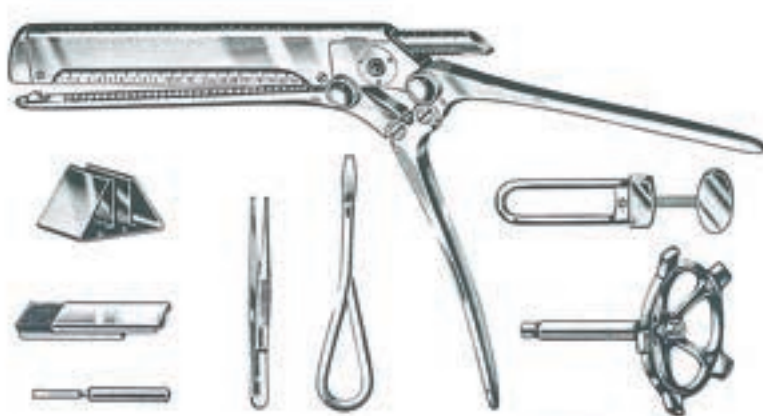

v. PETZ
64.320.00
compl.



300 Stück
300 ea.
300 pièces
300 c/u
300 pezzi

64.321.00

Prostata-Haken, -Faßzange
Prostatic Retractors, Grasping Forceps
Ecarteurs à prostate, Pince à saisir la prostate
Separadores, Pinza para coger prostata
Divaricatori, Pinza per afferrare la prostata

Urologie
Urology
Urologie
Urologia
Urologia



YOUNG
66.101.21
21 cm



YOUNG
66.103.22
22 cm



YOUNG
66.105.21
21 cm



YOUNG
66.106.20
20 cm



MILLIN
66.111.23-66.125.24



66.111.23
23 cm



66.117.23
23 cm

atraumatisch
atraumatic
atraumatique
atraumática
atraumatica

Für die Kapsel
For the capsule
Pour la capsula
Para la capsula
Per la capsula



MILLIN
66.123.23
23 cm

Für die vord. Lappen
Anterior Lobe
Pour lobe antérieur
Para lobo anterior
Per lobo anteriore

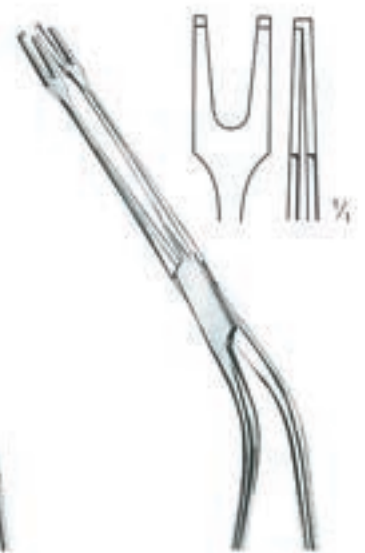

MILLIN
66.125.24
24 cm

Fadenführer
Ligature Carrier
Porte-ligature
Porta-ligaduras
Portafilo

66

Urologie
Urology
Urologie
Urologia
Urologia

Blasenspatel, -Wundsperrer
Bladder Retractors, Spreaders
Spatules, Ecarteurs vésicaux
Espátulas, Separadores vesicales
Spatole, Divaricatori vescicali



JUDD-MASSON
66.150.00



LEGUEU
66.147.27

KOCHER
66.149.27



THOMSON-WALKER
66.16C.00

Urologie
Urology
Urologie
Urologia
Urologia



LEGUEU
66.163.00



MILLIN
66.165.00

Fremdkörperzangen
Foreign Body Forceps
Pincas à corps étrangers
Pinzas para cuerpos extranjeros
Pinze per corpi estranei



cm	MATHIEU
20	66.168.20
28	66.168.28

Urethrotom, Messer auswärts
Urethrotome, cutting outward
Urétrótome, tranchant extérieur
Uretrótomo, cuchillos exteriores
Uretrótomo, coltelli esteriori

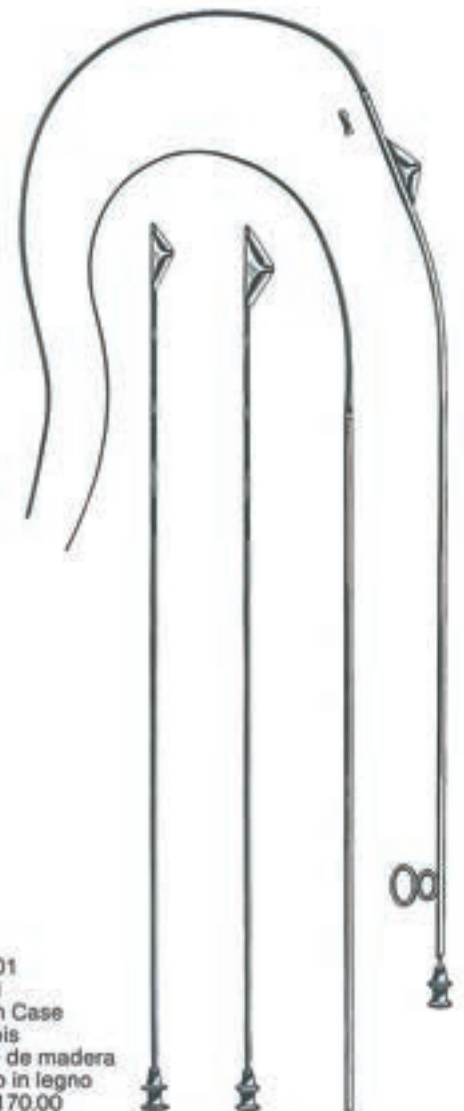

66.170.01
Holzetui
Wooden Case
Boîte bois
Estuche de madera
Astuccio in legno
f./p. 66.170.00

MAISONNEUVE
66.170.00
compl.

Urologie
Urology
Urologie
Urologia
Urologia

Sekretlöffel, Katheterspanner
Secretions Scoops, Catheter Introducer
Cuiller à sécrétions, Introducteur de sondes
Cucharillas p. secreciones, Introducitor de catéteres
Cucchiai per secrezioni, mandrini per sonde uretrali

Penisklemmen
Meatus Clamps
Compresseurs de l'urètre
Compresores uretrales
Serrapene



STOCKMANN
66.175.08
8 cm



STRAUSS
66.177.11
11 cm



GUTMANN
66.180.26



GUYON
66.184.39 66.185.35
39 cm 35 cm

Harnröhren-Dilatationsbesteck
Urethral Dilatation Set
Jeu d'instruments pour la dilatation de l'urètre
Juego de instrumentos para la dilatación de la uretra
Set di strumenti per la dilatazione uretrale



GUYON
66.200.00
compl.

Dilatations-Bougies, Metall-Katheter
Dilating Bougies, Metal Catheters
Bougies dilatatrices, Sondes métalliques
Bujías dilatadoras, Sondas metálicas
Candelette dilatatrici, Sonde metalliche

Urologie
Urology
Urologie
Urologia
Urologia

66



Charr./F.G.	van BUREN	GUYON*			COXETER
8	66.201.08	66.205.08	66.211.08	66.213.08	66.219.08
10	66.201.10	66.205.10	66.211.10	66.213.10	66.219.10
12	66.201.12	66.205.12	66.211.12	66.213.12	66.219.12
14	66.201.14	66.205.14	66.211.14	66.213.14	66.219.14
16	66.201.16	66.205.16	66.211.16	66.213.16	66.219.16
18	66.201.18	66.205.18	66.211.18	66.213.18	66.219.18
20	66.201.20	66.205.20	66.211.20	66.213.20	66.219.20
22	66.201.22	66.205.22	66.211.22	66.213.22	66.219.22
24	66.201.24	66.205.24	66.211.24	66.213.24	66.219.24
26	66.201.26	66.205.26			
28	66.201.28	66.205.28			
30	66.201.30	66.205.30			
32	66.201.32	66.205.32			
34	66.201.34	66.205.34			
36	66.201.36	66.205.36			
38		66.205.38			
40		66.205.40			

66.201.00
Set compl.
8-36

* Zwischengrößen:
Intermediate Sizes:
Dimensions intermédiaires:
Dimensiones intermediarias:
Dimensioni intermediari:

Ch./F.G.	No.
9	66.205.09
11	66.205.11
-	-
39	66.205.39

68

Mastdarm
Rectum
Rectum
Recto
Retto

Mastdarm-Spekula
Rectal Specula
Spéculum rectaux
Espéculos rectales
Specoli rettali



CZERNY
68.105.22
22 cm



SIMS
68.110.15
15 cm



BODENHAMMER
68.115.15
68.117.15 = Kaltlicht · Cold Light
15 cm
Lumière froide
Luz fría · Luce fredda



PRATT
68.121.00



BARR
68.125.17
70 x 22 mm
17 cm



MATHIEU
68.130.19
19,5 cm

Mastdarm-Spreizer
Anal Retractors
Dilatateurs p. anus et rectum
Separadores rectales
Dilatatori per l'ano e il retto

Mastdarm
Rectum
Rectum
Recto
Retto

68



ALAN-PARKS
68.147.00
compl.
13,5 cm



SMITH-BUIE
68.150.15
75 x 23 mm
15 cm

68.148.00
Kaltlicht-Adapter für 68.147.00
Cold Light Attachment for 68.147.00
Adaptateur lumière froide pour 68.147.00
Adaptador luz fría para 68.147.00
Adattatore luce fredda per 68.147.00

Rektoskop
Rectoscope
Rectoscope
Rectoscopio
Rettoscopio

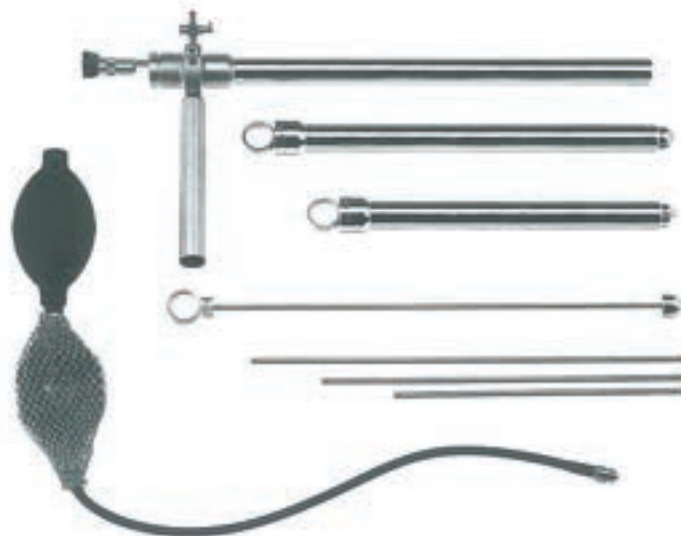

68.160.00
compl.

Kaltlicht · Cold Light · Lumière froide
Luz fría · Luce fredda
68.161.00
compl.

68

Mastdarm
Rectum
Rectum
Recto
Retto

Anoskope, Proktoskope
Anoscopes, Proctoscopes
Anuscopes, Proctoscopes
Anoscopios, Proctoscopios
Anoscopi, Proctoscopi



IVES-FANSLER
68.210.22
22 mm Ø
L = 80 mm



Ø mm	HIRSCHMANN
16	68.212.16
19	68.212.19
22	68.212.22
L = 65 mm	



mm Ø x L	KELLY
22 x 50	68.220.05
22 x 100	68.220.10
22 x 140	68.220.14
22 x 200	68.220.20



Ø mm	KELLY
21	68.224.21
27	68.224.27
L = 50 mm	

Cystikus-Haken
Cystic Hooks
Ecarteurs rectaux
Ganchos rectales
Uncini rettali



68.251.01
Fig. 1

68.251.02
Fig. 2

68.251.03
Fig. 3

PRATT
68.251.01-68.251.03

Mastdarm
Rectum
Rectum
Recto
Retto

68



BUIE
68.261.41
41 cm

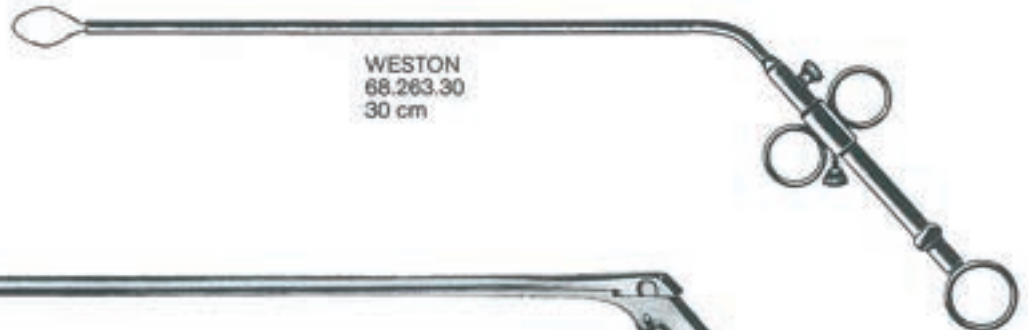

WESTON
68.263.30
30 cm

Biopsie-Zangen
Biopsy Specimen Forceps
Pinças emporte-pièce à biopsie
Pinzas sacabocado para biopsia
Pinze per biopsia

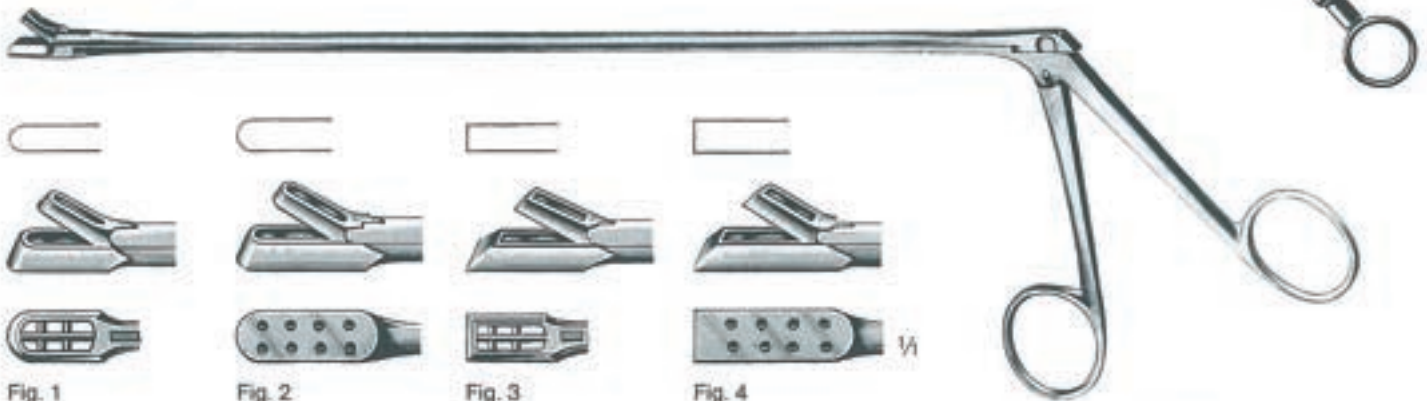

Fig. 1

Fig. 2

Fig. 3

Fig. 4

				cm	YEOMAN
68.301.28	68.302.28	68.303.28	68.304.28	28	
68.301.35	68.302.35	68.303.35	68.304.35	35	
68.301.42	68.302.42	68.303.42	68.304.42	42	



drehbar
rotatable
rotative
giratoria
girevole

cm	YEOMAN
23	68.311.23
33	68.311.33
40	68.311.40



drehbar
rotatable
rotative
giratoria
girevole

cm	TURREL
23	68.321.23
33	68.321.33
40	68.321.40

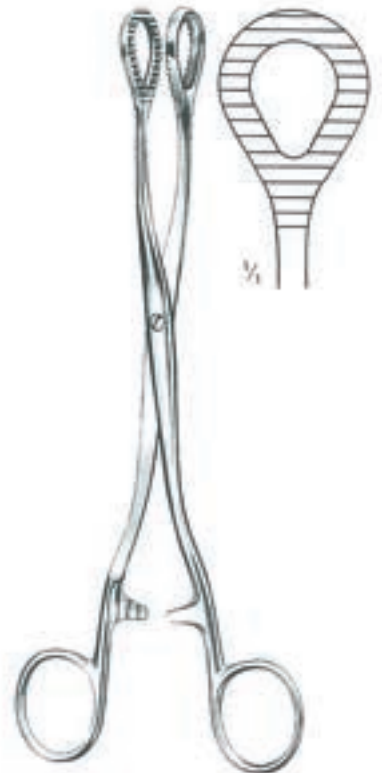

HEYWOOD-SMITH
68.402.21
21 cm

70

Gynäkologie
Gynecology
Gynécologie
Ginecología
Ginecologia



GRAVE			
Fig.	mm	Standard	Laser Mod.
1	75x20	70.110.01	
2	95x35	70.110.02	70.114.02
3	115x35	70.110.03	70.114.03

Scheiden-Spekula
Vaginal Specula
Spéculum vaginaux
Espéculos vaginales
Specoli vaginali



PEDERSON			
Fig.	mm		
70.120.01	1	75x13	
70.120.02	2	100x22	
70.120.03	3	120x25	



COLLIN			
Fig.	mm		
70.130.01	1	85x30	
70.130.02	2	100x35	
70.130.03	3	110x40	



COLLIN
70.131.00
65x20 mm



COLLIN
70.132.00
65x10 mm



Seitl. Schraube
Lateral Screw
Vis latérale
Tornillo lateral
Vite laterale

CUSCO			
Fig.	mm	Standard	Laser Mod.
1	75x32	70.140.01	
2	85x35	70.140.02	70.144.02
3	100x35	70.140.03	70.144.03

Gynäkologie
Gynecology
Gynécologie
Ginecologia
Ginecologia



Scheiden-Spekula
Vaginal Specula
Spéculum vaginaux
Espéculos vaginales
Specoli vaginali

CUSCO
70.142.00
75x17 mm

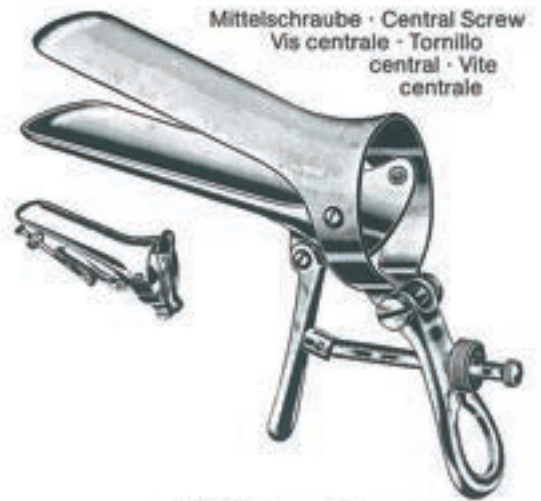

Mittelschraube · Central Screw
Vis centrale · Tornillo
central · Vite
centrale

CUSCO	Fig.	mm
70.150.01	1	75x32
70.150.02	2	85x36
70.150.03	3	95x37



Schweizer Modell · Swiss Pattern
Modèle suisse · Modelo suizo
Modello svizzero

CUSCO	Fig.	mm
70.160.01	1	90x23-25
70.160.02	2	100x25-27
70.160.03	3	110x27-30



SEMM	mm
70.190.01	100x17-20
70.190.02	100x25-30

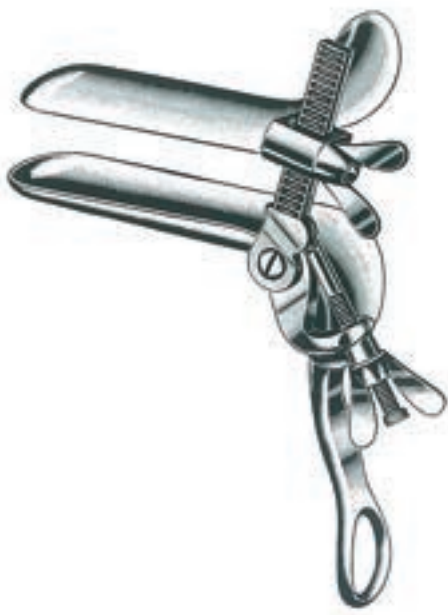

TRELAT	mm
70.180.01	85x33
70.180.02	95x35
70.180.03	115x43

Gynäkologie
Gynecology
Gynécologie
Ginecologia
Ginecologia

70

Scheiden-Spekula
Vaginal Specula
Spéculums vaginaux
Espéculos vaginales
Specoli vaginali

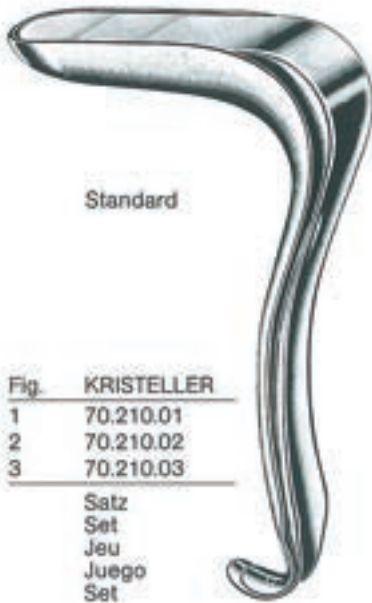
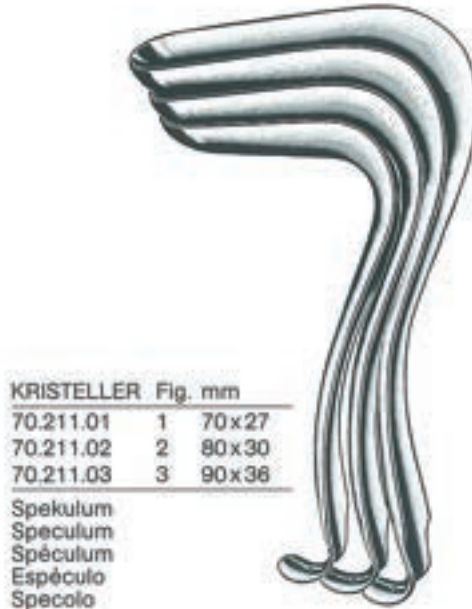
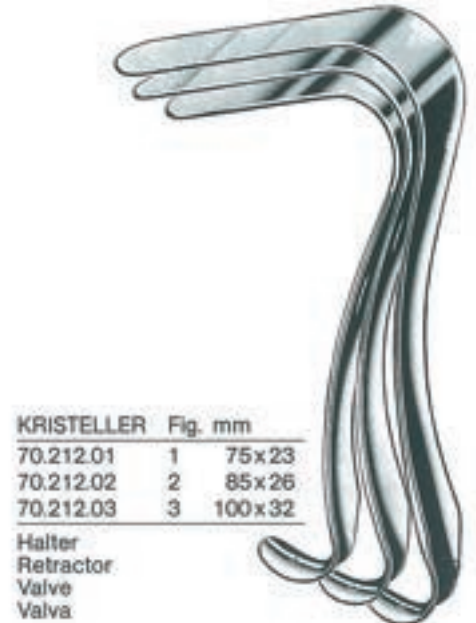

Fig.	KRISTELLER
1	70.210.01
2	70.210.02
3	70.210.03
Satz	
Set	
Jeu	
Juego	
Set	



KRISTELLER	Fig.	mm
70.211.01	1	70x27
70.211.02	2	80x30
70.211.03	3	90x38
Spekulum		
Speculum		
Spéculum		
Espéculo		
Specolo		



KRISTELLER	Fig.	mm
70.212.01	1	75x23
70.212.02	2	85x26
70.212.03	3	100x32
Halter		
Retractor		
Valve		
Valva		

Mit konischen Blättern, für Jungfrauen
With taper blades, for virgins
A valves coniques, pour vierges
Con hojas cónicas, para vírgenes
Con valve coniche, per vergini

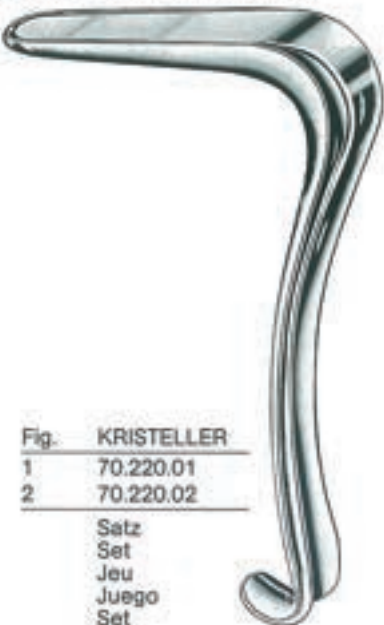

Fig.	KRISTELLER
1	70.220.01
2	70.220.02
Satz	
Set	
Jeu	
Juego	
Set	



KRISTELLER	mm
70.221.01	105x18
70.221.02	105x21
Spekulum	
Speculum	
Spéculum	
Espéculo	
Specolo	



KRISTELLER	mm
70.222.01	110x14
70.222.02	115x17
Halter	
Retractor	
Valve	
Valva	

Gynäkologie
Gynecology
Gynécologie
Ginecología
Ginecologia

70



Flache Specula
Specula Flat Hollow
Spéculums plats
Espéculos con huecos planos
Specoli piatti

Fig.	KRISTELLER
1	70.230.01
2	70.230.02
3	70.230.03

Satz
Set
Jeu
Juego
Set

KRISTELLER	Fig.	mm
70.231.01	1	105x26
70.231.02	2	105x28
70.231.03	3	105x33

Spekulum
Speculum
Spéculum
Espéculo
Specolo



KRISTELLER	Fig.	mm
70.232.01	1	115x22
70.232.02	2	115x24
70.232.03	3	115x29

Halter
Retractor
Valve
Valva

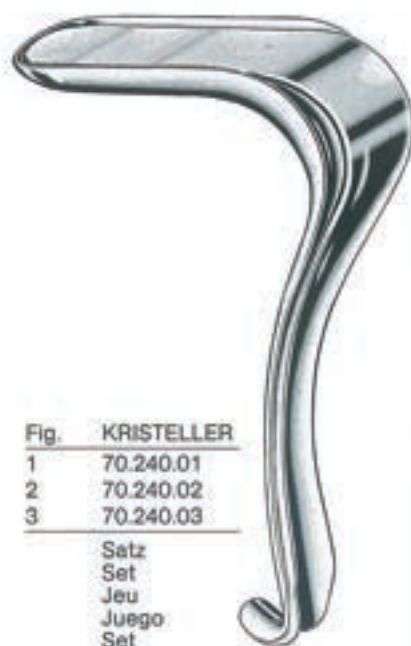

Tiefe Spekula
Specula Deep Hollow
Spéculums profonds
Espéculos con huecos profundos
Specoli profondi

Fig.	KRISTELLER
1	70.240.01
2	70.240.02
3	70.240.03

Satz
Set
Jeu
Juego
Set

KRISTELLER	Fig.	mm
70.241.01	1	110x27
70.241.02	2	110x30
70.241.03	3	110x36

Spekulum
Speculum
Spéculum
Espéculo
Specolo



KRISTELLER	Fig.	mm
70.242.01	1	115x23
70.242.02	2	115x26
70.242.03	3	115x32

Halter
Retractor
Valve
Valva

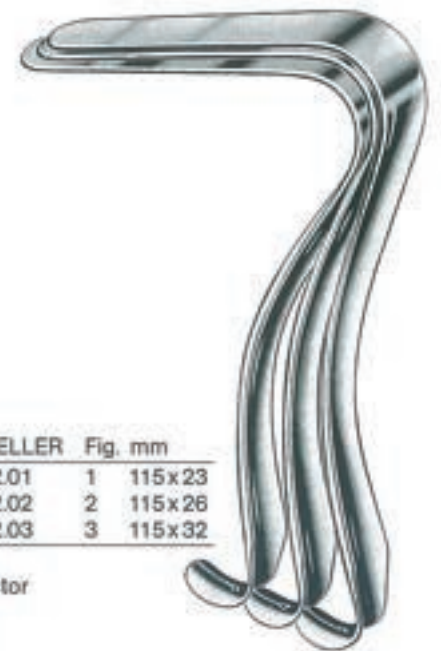

Gynäkologie
Gynecology
Gynécologie
Ginecologia
Ginecologia

70

Scheiden-Spekula
Vaginal Specula
Spéculums vaginaux
Espéculos vaginales
Specoli vaginali



Extra großes Modell
Extra large pattern
Modèle extra grand
Modelo muy grande
Modello molto grande

KRISTELLER
70.250.00
Set

KRISTELLER
70.251.00
135x38 mm

KRISTELLER
70.252.00
140x30 cm



KALLMORGEN
70.260.01-70.262.02

KALLMORGEN	Fig.	Set	Spekulum Speculum Spéculum Espéculo Specolo	mm	Halter Retractor Valve Valva	mm
	1	70.260.01	70.261.01	70x40	70.262.01	70x33
	2	70.260.02	70.261.02	90x40	70.262.02	90x33

Scheiden-Spekula
Vaginal Specula
Spéculum vaginaux
Espéculos vaginales
Specoli vaginali

Gynäkologie
Gynecology
Gynécologie
Ginecologia
Ginecologia

70



JACKSON	Fig.	mm
70.271.01	1	75x38
70.271.02	2	90x38
70.271.03	3	100x38



Fig. 1 = klein/small/petit
pequeño/piccolo
Fig. 2 = mittel/medium/moyen
mediano/medio
Fig. 3 = groß/large/grand
grande

SIMS	Fig.
70.281.01	1
70.281.02	2
70.281.03	3



SIMS	Fig.
70.291.01	1
70.291.02	2
70.291.03	3
70.291.00 = Set	



DOYEN	Fig.	mm
70.301.01	1	55x35
70.301.02	2	85x35
70.301.03	3	115x35
70.303.01	1	55x45
70.303.02	2	85x45
70.303.03	3	115x45
70.303.04	4	160x45
70.305.01	1	55x60
70.305.02	2	85x60
70.305.03	3	115x60
70.305.04	4	160x60



DOYEN
70.301.01-70.305.04

Gynäkologie
Gynecology
Gynécologie
Ginecologia
Ginecologia

70

Scheiden-Spekula
Vaginal Specula
Spéculum vaginaux
Espéculos vaginales
Specoli vaginali



Losses Gewicht
Detachable Weight
Poids démontable
Peso desmontable
Peso smontabile

AUVARD

Festes Gewicht
Fixed Weight
Poids fixe
Peso fija
Peso fiso

70.309.00



mm	BREISKY
100x20	70.310.20
100x25	70.310.25
100x30	70.310.30
100x35	70.310.35
100x40	70.310.40
130x20	70.313.20
130x25	70.313.25
130x30	70.313.30
130x35	70.313.35
130x40	70.313.40
155x40	70.315.40



mm	LANDAU
100x28	70.319.28
100x38	70.319.38



FRIEDMANN
70.351.10
10 cm



Standard	KOGAN	Laser
70.360.24	24 cm	70.364.24

Uterus-Dilatatoren
Uterine Dilators
Dilatateurs utérins
Dilatadores uterinos
Dilatatori uterini



mm	HEGAR		mm
1	70.410.01	70.415.01	1,5
2	70.410.02	70.415.02	2,5
3	70.410.03	70.415.03	3,5
4	70.410.04	70.415.04	4,5
5	70.410.05	70.415.05	5,5
6	70.410.06	70.415.06	6,5
7	70.410.07	70.415.07	7,5
8	70.410.08	70.415.08	8,5
9	70.410.09	70.415.09	9,5
10	70.410.10	70.415.10	10,5
11	70.410.11	70.415.11	11,5
12	70.410.12	70.415.12	12,5
13	70.410.13	70.415.13	13,5
14	70.410.14	70.415.14	14,5
15	70.410.15	70.415.15	15,5
16	70.410.16	70.415.16	16,5
17	70.410.17		
18	70.410.18		
19	70.410.19		
20	70.410.20		
21	70.410.21		
22	70.410.22		
23	70.410.23		
24	70.410.24		
25	70.410.25		
26	70.410.26		
27	70.410.27		
28	70.410.28		
29	70.410.29		
30	70.410.30		

70.404.14 Satz/Set/Jeu/Juego
70.410.04-70.410.17 = 14
70.404.26 Satz/Set/Jeu/Juego
70.410.01-70.410.26 = 26



HEGAR
70.405.14
4-17 mm
14 Stück/ea./pces./c./u./pezzi



mm	HEGAR	
4-17	70.406.14	14 Stück/ea./pces./c./u./pezzi
1-26	70.406.26	26 Stück/ea./pces./c./u./pezzi

70

Uterus-Dilatatoren
Uterine Dilators
Dilatateurs utérins
Dilatadores uterinos
Dilatatori uterini



mm	HEGAR
1/ 2	70.420.01
3/ 4	70.420.03
5/ 6	70.420.05
7/ 8	70.420.07
9/10	70.420.09
11/12	70.420.11
13/14	70.420.13
15/16	70.420.15
17/18	70.420.17
19/20	70.420.19
21/22	70.420.21
23/24	70.420.23
25/26	70.420.25

70.424.08 Satz/Set/Jeu/Juego
70.420.03-70.420.17 = 8

70.424.13 Satz/Set/Jeu/Juego
70.420.01-70.420.25 = 13

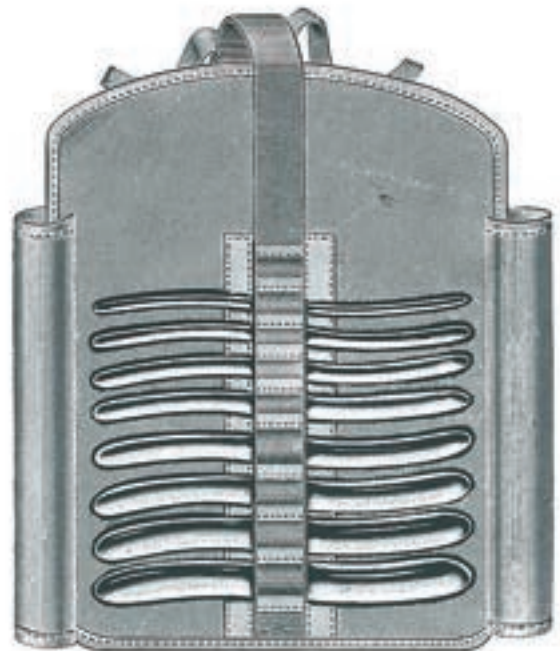

HEGAR
70.425.08
3/4-17/18 mm
8 Stück/ea./pces./c./u./pezzi



mm	HEGAR	
3/4-17/18	70.426.08	8 Stück/ea./pces./c./u./pezzi
1/2-25/26	70.426.13	13 Stück/ea./pces./c./u./pezzi

Uterus-Dilatatoren
Uterine Dilators
Dilatateurs utérins
Dilatadores uterinos
Dilatatori uterini

70

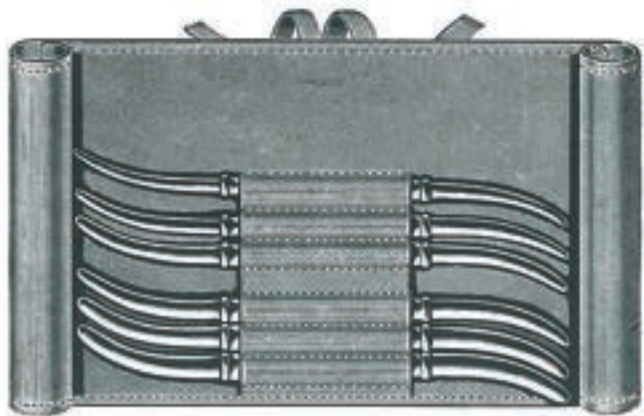

HANK
70.436.08
Set/6

mm	HANK	Fig. U.S.
4,5/ 5	70.430.10	9/10
5,5/ 6	70.430.12	11/12
6,5/ 7	70.430.14	13/14
7,5/ 8	70.430.16	15/16
8,5/ 9	70.430.18	17/18
9,5/10	70.430.20	19/20

70.435.06
Set/6



GOODELL
70.441.34
34 cm



WYLIE
70.443.29
29 cm



SIMS
70.445.29
29 cm

Gynäkologie
Gynecology
Gynécologie
Ginecologia
Ginecologia

Hakenzangen
Tenaculum Forceps
Pinces pour abaissement du col de l'utérus
Pinzas para coger el cuello del útero
Pinze per abbassare il collo dell'utero



SCHROEDER
70.502.25
25 cm



BRAUN
70.504.25
25 cm



SKENE
70.505.24
24 cm



DUPLAY
70.507.28
28 cm

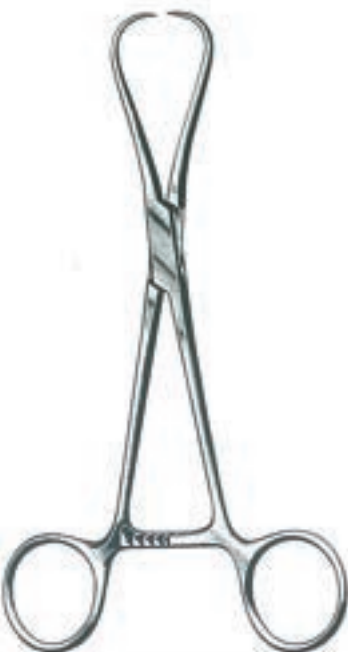

STAUDE-MOORE
70.508.17
17 cm



BARRETT
70.510.18
18 cm



JARCHO
70.512.20
20 cm

Hakenzangen
Vulsellum Forceps
Pinces pour abaissement du col de l'utérus
Pinzas para coger el cuello del útero
Pinze per abbassare il collo dell'utero

Gynäkologie
Gynecology
Gynécologie
Ginecologia
Ginecologia

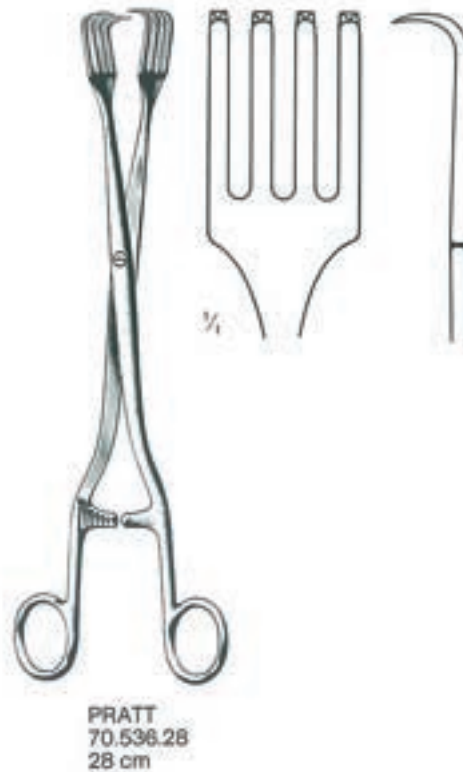
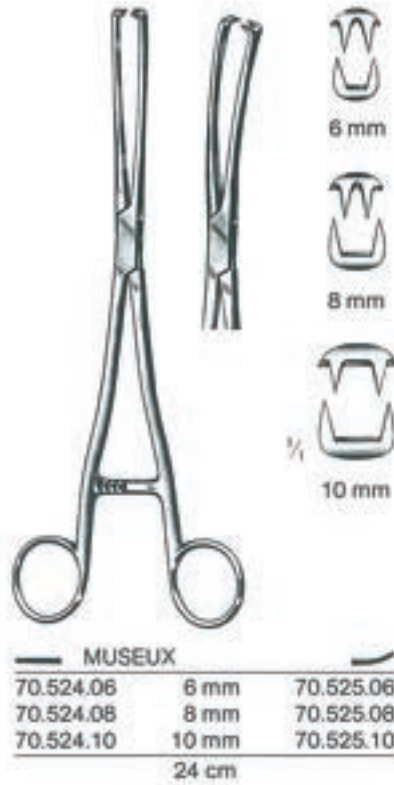
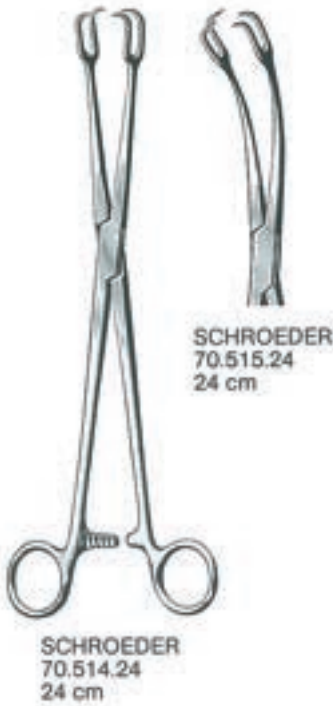

Gynäkologie
Gynecology
Gynécologie
Ginecologia
Ginecologia

70

Uterus-Polypenzangen
Uterine Polypus Forceps
Pincès à polypes utérins
Pinzas para pólipos uterinos
Pinze per polipi uterini



NOTO
70.540.27
27 cm



DOYEN
70.542.20
20 cm

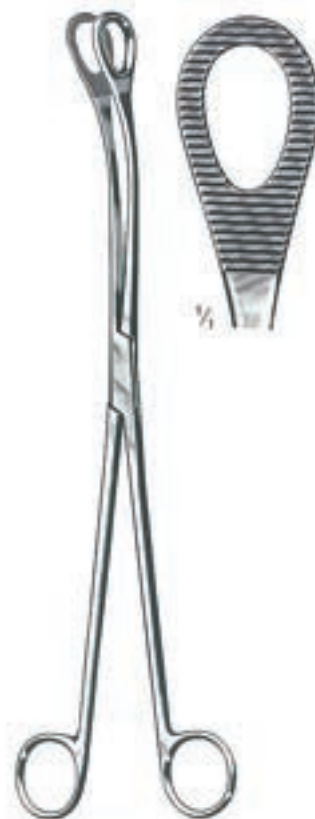

KELLY
70.543.32
32 cm

Uterus-Faßzangen
Uterine Elevating Forceps
Pincès hystérolabes
Pinzas para el útero
Pinze per afferrare l'utero



DARTIGUES
70.545.27
27 cm



SOMER
70.547.23
23 cm



COLLIN
70.549.25
25 cm

Gynäkologie
Gynecology
Gynécologie
Ginecología
Ginecologia



Amniotom
Amniotome
Amniotome
Amniótomo
Amniotomo

BEACHAM
70.559.26
26 cm



Uterus-Depressoren
Uterine Depressors
Dépresseurs utérins
Depresores uterinos
Depressori uterini

BRAUN
70.565.28
28 cm



SIMS
70.567.26
26 cm



Uterus-Sonden
Uterine Sounds
Hystéromètres
Histerómetros
Isterometri

starr
rigid
rigide
rigida
rigida

SIMS

70.580.32 32 cm

biegsam
malleable
malleable
malleable
malleabile

70.581.32



starr
rigid
rigide
rigida
rigida

MARTIN

70.582.32 32 cm

biegsam
malleable
malleable
malleable
malleabile

70.583.32



COLLIN
70.584.28
28 cm

70

Gynäkologie
Gynecology
Gynécologie
Ginecologia
Ginecologia

Uterus-Biopsie-Saugküretten
Uterine Biopsy Aspirating Curettes
Curettes aspirantes à biopsie de l'utérus
Curetas aspiradoras p. la biopsia uterina
Curette di aspirazione per biopsia



RANDALL
70.590.04
24 cm/4 mm



mm	NOVAK
1	70.592.01
2	70.592.02
3	70.592.03
4	70.592.04



KEVORKIAN		mit Korb with basket avec grille con cesto con cestino
70.594.12	1,2 mm	
70.594.40	4,0 mm	70.596.40
	30 cm	

Gynäkologie
Gynecology
Gynécologie
Ginecologia
Ginecologia

Probeexcisionszangen
Biopsy Specimen Forceps
Pinces emporte-pièce pour le col de l'utérus
Pinzas sacabocado para el cuello del útero
Pinze taglienti per biopsia



FAURE
70.601.21
21 cm



cm	SCHUBERT
21	70.604.21
28	70.604.28



SCHUBERT
70.605.26
26 cm

Gynäkologie
Gynecology
Gynécologie
Ginecología
Ginecologia

Biopsiezangen
Biopsy Specimen Forceps
Pinces à biopsie
Pinzas sacabocado p. biopsia
Pinze per biopsia

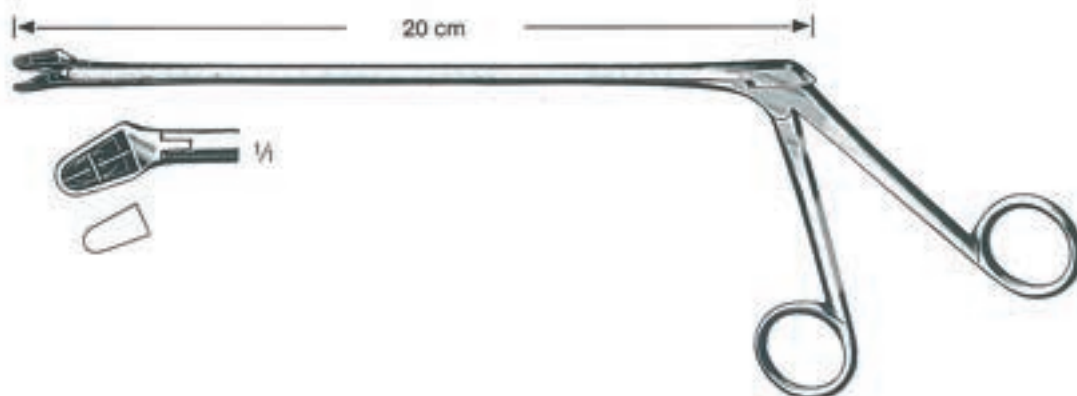

Biopsiezangen
Biopsy Specimen Forceps
Pincès à biopsie
Pinzas sacabocado p. biopsia
Pinze per biopsia

70

70.615.01

70.615.02

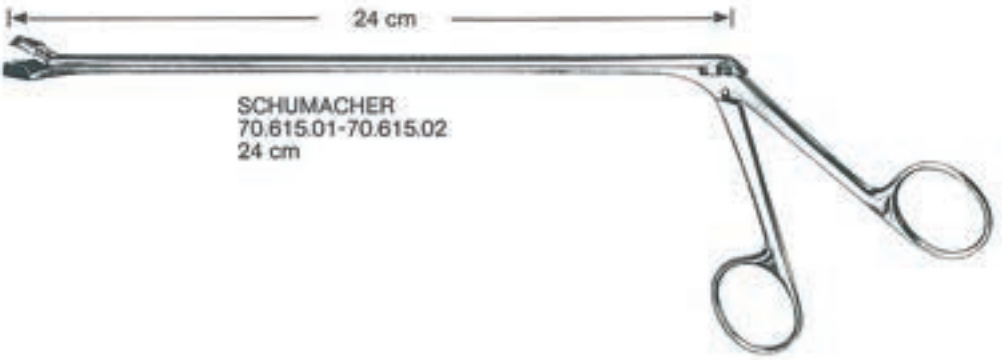

3x9,7 mm



4x8 mm



3x7 mm



Gynäkologie
Gynecology
Gynécologie
Ginecología
Ginecologia

70

Biopsiezangen
Biopsy Specimen Forceps
Pinces à biopsie
Pinzas sacabocado p. biopsia
Pinze per biopsia



oval
7x5 mm

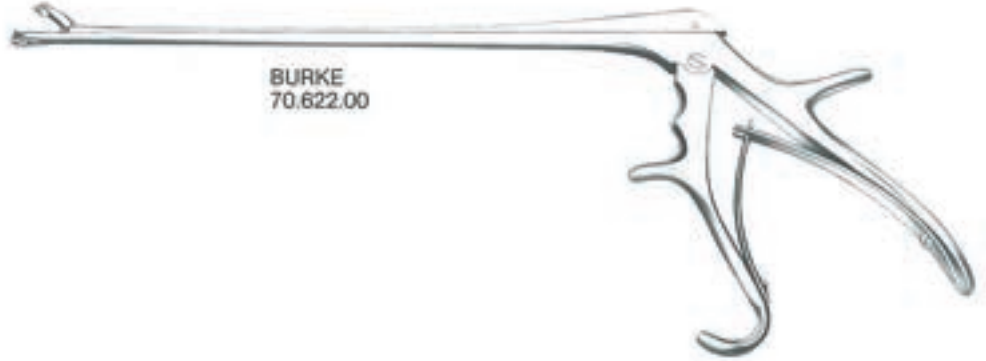

BURKE
70.622.00



Fig. 1

- TISCHLER-Morgan

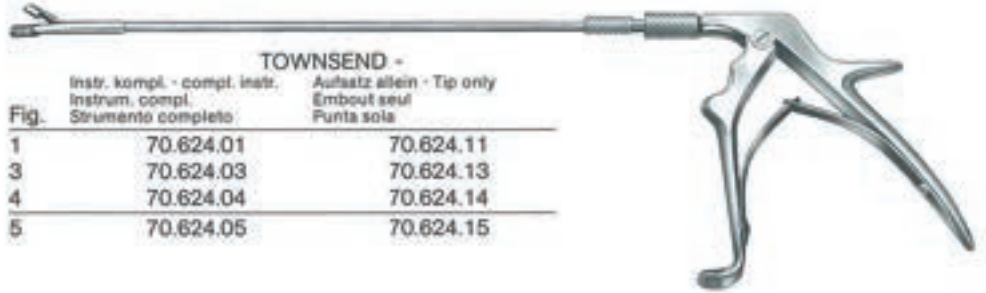

TOWNSEND -

Fig.	Instr. kompl. - compl. instr. Instrum. compl. Strumento completo	Aufsatz allein - Tip only Embout seul Punta sola
1	70.624.01	70.624.11
3	70.624.03	70.624.13
4	70.624.04	70.624.14
5	70.624.05	70.624.15



Fig. 3

oval ● 3,7x5 mm



Fig. 5

mini



Fig. 4

- KEVORKIAN



■ 3x8 mm



KEVORKIAN-Pacific
70.625.04

Biopsiezangen
Biopsy Specimen Forceps
Pinces à biopsie
Pinzas sacabocado p. biopsia
Pinze per biopsia

70



2,3x4,2 mm



TOWNSEND-Mini (BABY TISCHLER)
70.626.00



3x9,5 mm



TISCHLER-KEVORKIAN
70.627.00



4x6,5 mm



BAGGISH
70.628.00



4,5x8 mm

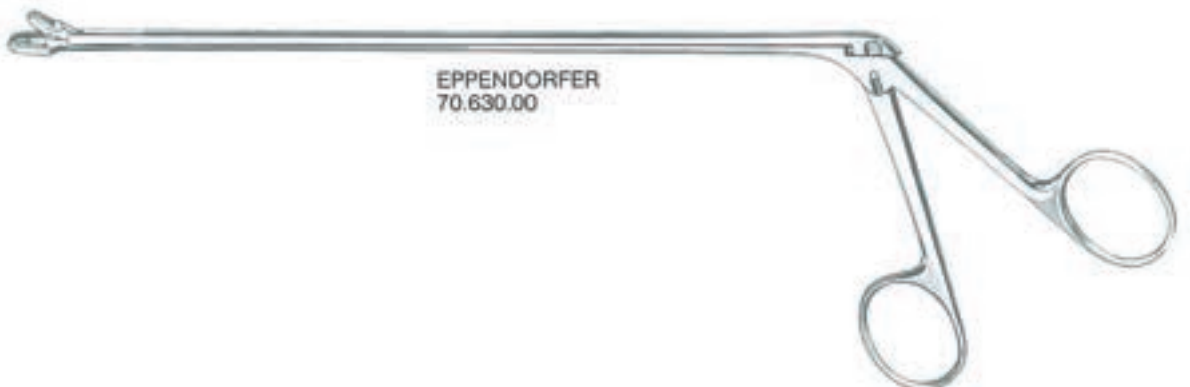

EPPENDORFER
70.630.00

Gynäkologie
Gynecology
Gynécologie
Ginecologia
Ginecologia

70

Biopsiezangen
Biopsy Specimen Forceps
Pincès à biopsie
Pinzas sacabocado p. biopsia
Pinze per biopsia

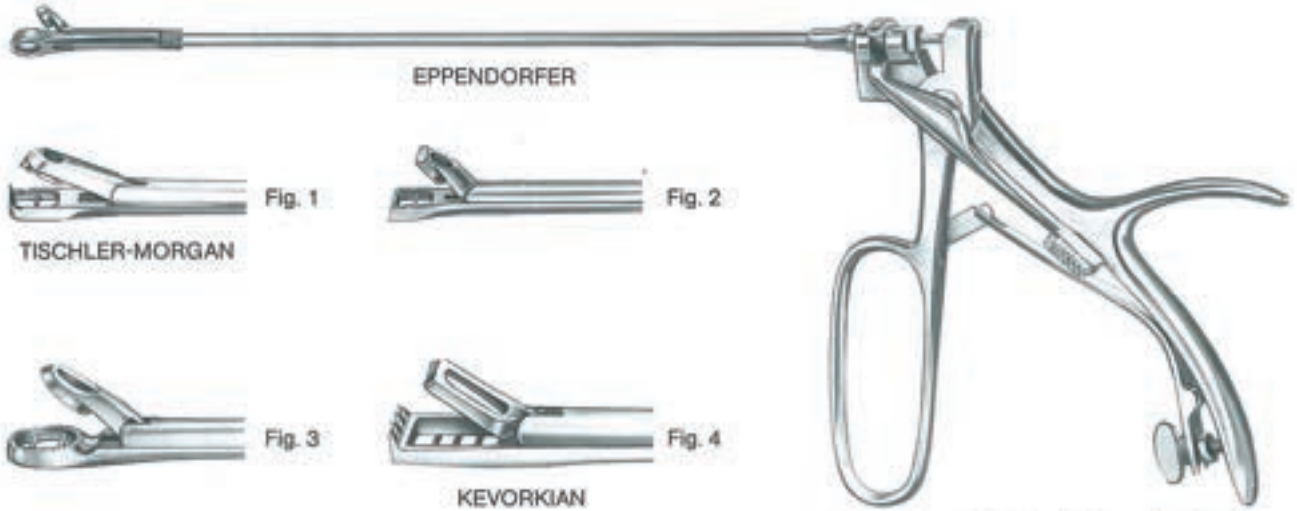

Fig.	Instr. kompl. - compl instr. Instrum. compl. Strumento completo	Aufsatz allein - Tip only Embout seul Punta sola
1	70.632.01	70.632.11
2	70.632.02	70.632.12
3	70.632.03	70.632.13
4	70.632.04	70.632.14

Myom-Heber
Myoma Screw
Tracteur pour fibromes
Tirabuzón para fibromas
Tiramiomi



DOYEN
70.641.17
17 cm

Myommesser
Myoma Knife
Bistouri à fibromes
Bisturi para fibromas
Busturi per fibromi



SEGOND
70.643.27
27 cm

Fistelhaken
Fistula Hooks
Crochets à fistules
Ganchos para fistulas
Uncini per fistole

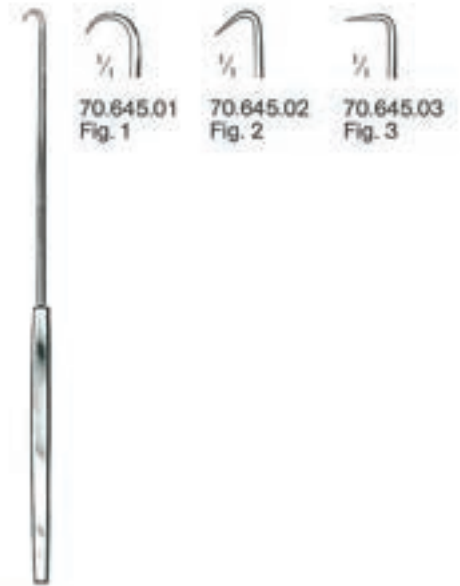

EMMET
70.645.01-70.645.03
22 cm

Gynäkologie
Gynecology
Gynécologie
Ginecologia
Ginecologia

Salpingograph
Salpingograph
Salpingographie
Salpingógrafo
Salpingografo



SCHULTZE
70.650.00
compl.

scharf
sharp
tranchant
cortante
tagliente



Fig.	SIMON
1	70.702.01
2	70.702.02
3	70.702.03
4	70.702.04
5	70.702.05
6	70.702.06
25 cm	



Uteruslöffel, -kürette
Uterine Curettes
Curettes utérines
Curetas uterinas
Curette uterine

scharf/stumpf
sharp/blunt
tranchant/mousse
cortante/roma
tagliente/smussa



BLAKE
70.704.27
27 cm

Gynäkologie
Gynecology
Gynécologie
Ginecologia
Ginecologia

Uterus-Küretten
Uterine Curettes
Curettes utérines
Curetas uterinas
Curette uterine

70

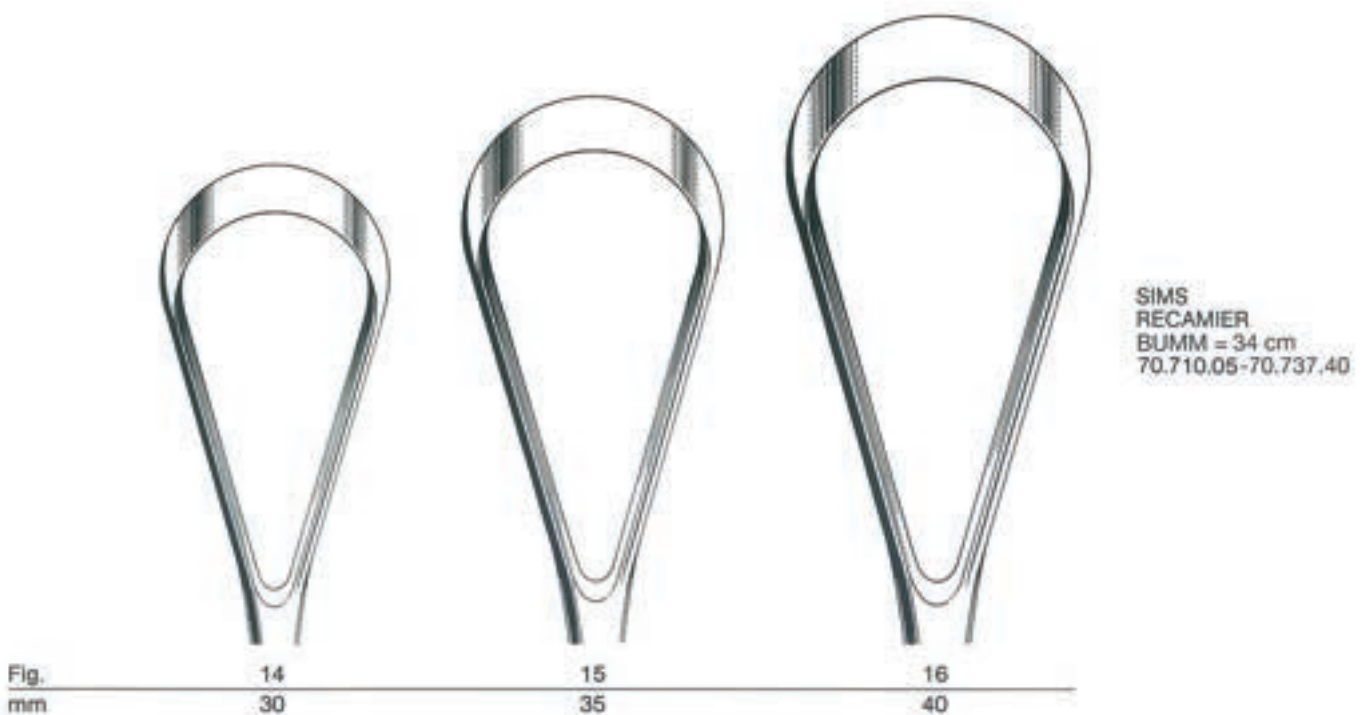
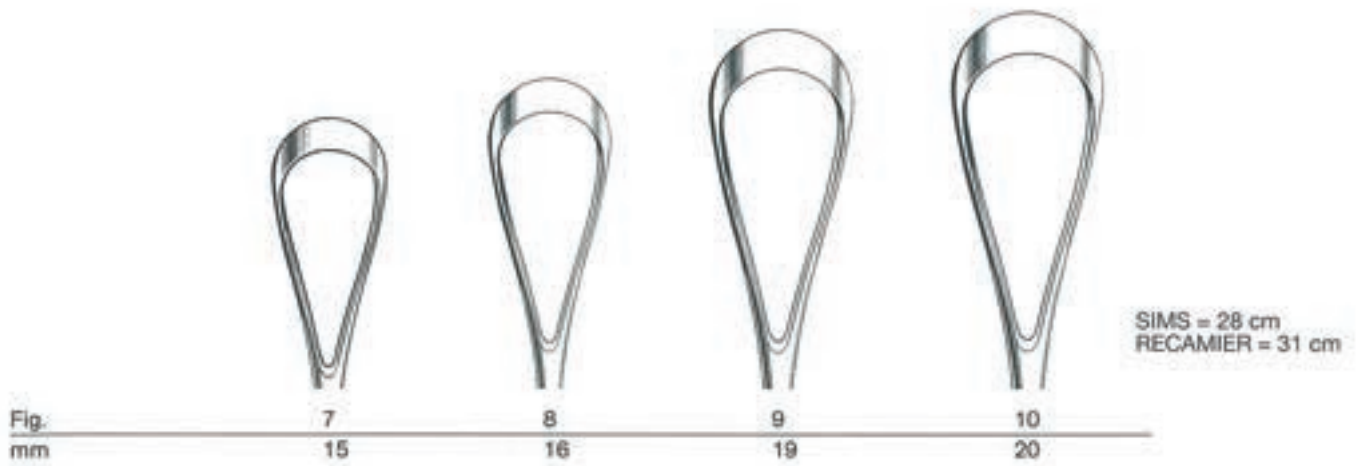
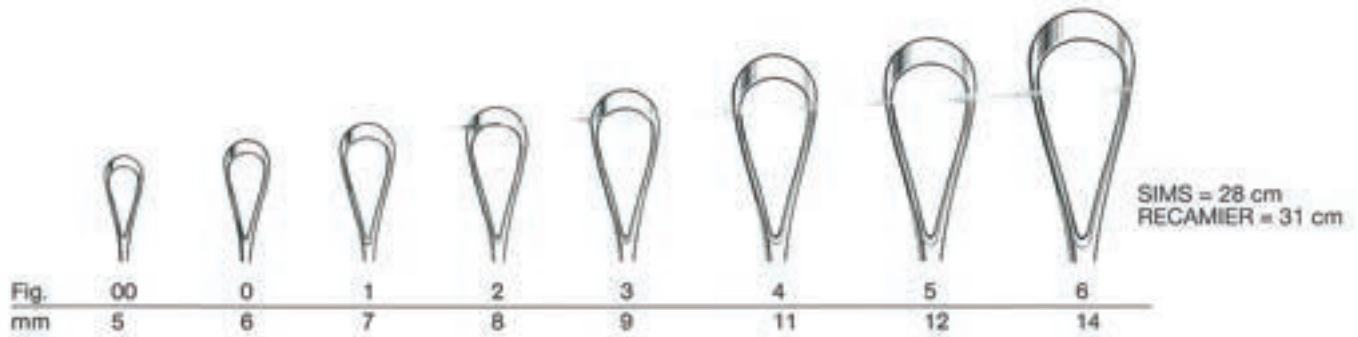

Gynäkologie
Gynecology
Gynécologie
Ginecologia
Ginecologia

Uterus-Küretten
Uterine Curettes
Curettes utérines
Curetas uterinas
Curette uterine



SIMS
70.710.05-70.717.14
28 cm



RECAMIER
70.720.07-70.727.20
31 cm



BUMM
70.730.30-70.737.40
34 cm

Ausführung Features Exécution Ejecución Esecuzione	scharf sharp tranch. cort. tagli.	stumpf blunt mousse roma smussa
fest/rig.	A	B
flex./fless.	C	D

Fig.	A	B	C	D	A	B	C	D	A	B	C	D
00	70.710.05	70.712.05	70.715.05	70.717.05								
0	70.710.06	70.712.06	70.715.06	70.717.06								
1	70.710.07	70.712.07	70.715.07	70.717.07	70.720.07	70.722.07	70.725.07	70.727.07				
2	70.710.08	70.712.08	70.715.08	70.717.08	70.720.08	70.722.08	70.725.08	70.727.08				
3	70.710.09	70.712.09	70.715.09	70.717.09	70.720.09	70.722.09	70.725.09	70.727.09				
4	70.710.11	70.712.11	70.715.11	70.717.11	70.720.11	70.722.11	70.725.11	70.727.11				
5	70.710.12	70.712.12	70.715.12	70.717.12	70.720.12	70.722.12	70.725.12	70.727.12				
6	70.710.14	70.712.14	70.715.14	70.717.14	70.720.14	70.722.14	70.725.14	70.727.14				
7					70.720.15	70.722.15	70.725.15	70.727.15				
8					70.720.16	70.722.16	70.725.16	70.727.16				
9					70.720.19	70.722.19	70.725.19	70.727.19				
10					70.720.20	70.722.20	70.725.20	70.727.20				
14									70.730.30	70.732.30	70.735.30	70.737.30
15									70.730.35	70.732.35	70.735.35	70.737.35
16									70.730.40	70.732.40	70.735.40	70.737.40

Geburtshilfe
Obstetrics
Accouchements
Obstetricia
Ostetricia

72

Geburtszangen
Obstetrical (Midwifery) Forceps
Forceps
Fórceps obstétricos
Forcipli



WRIGLEY
72.101.23
23 cm



SIMPSON
72.102.30
30 cm



cm	SIMPSON-BRAUN
33	72.105.33
36	72.105.36



De LEE
72.107.30
30 cm



cm	De LEE
36	72.108.36
39	72.108.39



KIELLAND
72.110.41
41 cm



cm	ELLIOT
32	72.115.32
38	72.115.38



cm	NAEGELE
36	72.119.36
40	72.119.40

Geburtszangen
Obstetrical (Midwifery) Forceps
Forceps
Fórceps obstétricos
Forcipi

Geburtshilfe
Obstetrics
Accouchements
Obstetricia
Ostetricia



LUIKART
72.125.40
40 cm



KIELLAND-LUIKART
72.127.40
40 cm



SIMPSON-LUIKART
72.135.36
36 cm



McLEAN-TUCKER-LUIKART
72.139.40
40 cm



McLEAN-TUCKER
72.141.39
39 cm



McLEAN-LUIKART
72.143.39
39 cm



McLEAN
72.145.36
36 cm



BARTON
72.147.36
36 cm



BARTON
72.148.17
17 cm

72
Geburtszangen
Obstetrical (Midwifery) Forceps
Forceps
Fórceps obstétricos
Forcipi



BOERMA
72.151.29
29 cm



PIPER
72.155.44
44 cm



PIPER
72.157.40
40 cm



DEWEY
72.160.37
37 cm

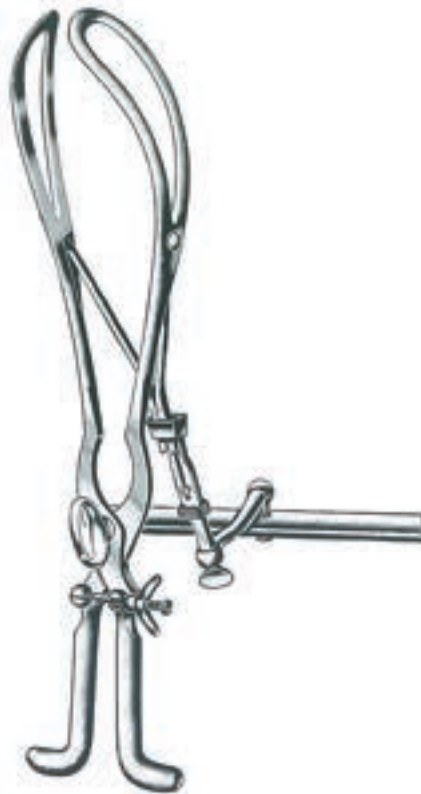

TARNIER
72.162.40
40 cm



BILL
72.170.00



LUIKART-BILL
72.171.21
21 cm

Geburtshilfe
Obstetrics
Accouchements
Obstetricia
Ostetricia



SMELLIE
72.181.33
33 cm



GAUSS
72.183.27
27 cm



GREEN-ARMYTAGE
72.184.21
21 cm



COLLIN
72.187.09
9 cm

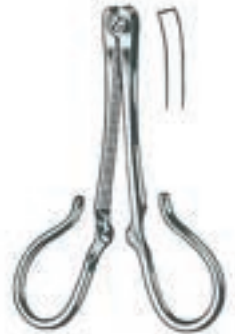

KANE
72.189.09
8,5 cm

Nabelschnurklemmen
Umbilical Cord Clamps
Clamps p. cordon ombilical
Clamps umbilicales
Pinze ombelicali

Beckenzirkel
Pelvimeters
Compas pelvimètres
Pelvimetros
Pelvimetri



MARTIN
72.191.34
34 cm



COLLIER
72.193.30
30 cm



COLLIN
72.195.35
35 cm

72

Geburtshilfe
Obstetrics
Accouchements
Obstetricia
Ostetricia

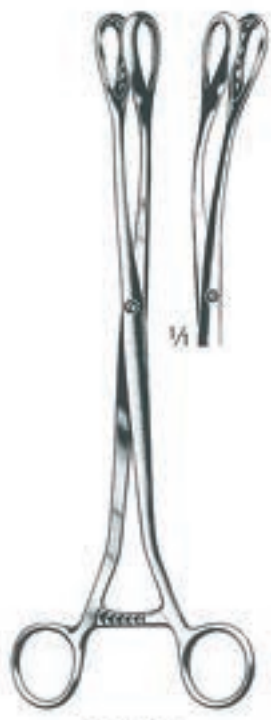

SAENGER
72.242.27 27 cm 72.243.27



WINTER
72.244.01-72.245.03
28 cm

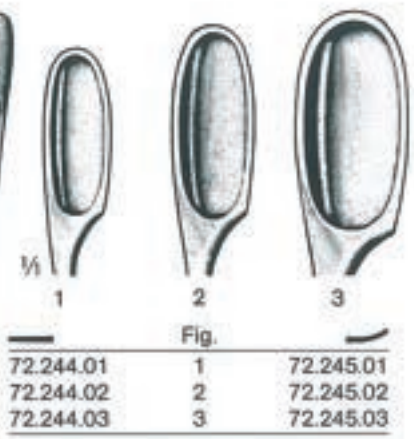

	Fig.	
72.244.01	1	72.245.01
72.244.02	2	72.245.02
72.244.03	3	72.245.03



PESTALOZZA
72.252.30
30 cm



CUZZI
72.254.14-72.254.21
30 cm



72.254.14
14,5 mm



72.254.18
18 mm



72.254.21
21 mm



WALLICH
72.256.42
42 cm



Geburtshilfe
Obstetrics
Accouchements
Obstetricia
Ostetricia



SELLHEIM
72.259.28
28 cm



BRAUN
72.302.42
42 cm

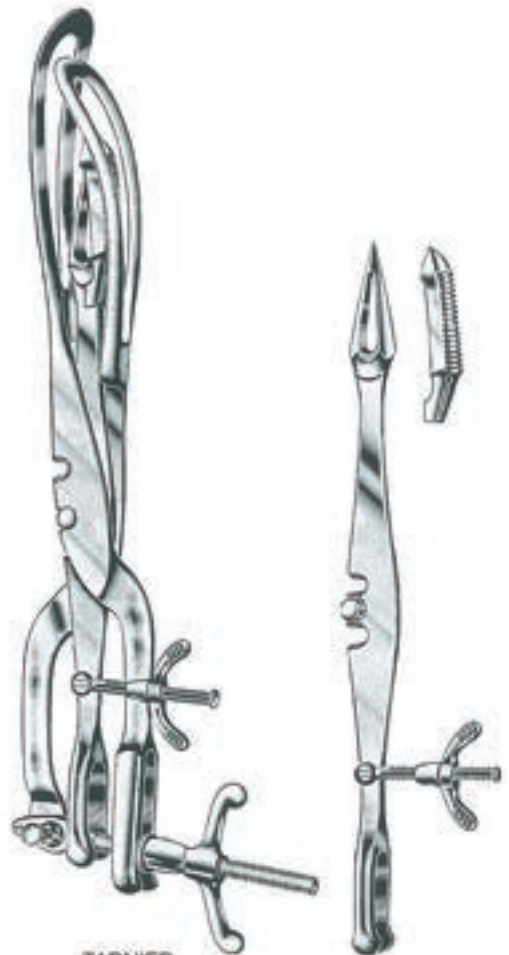

TARNIER
72.304.46
46 cm



SMELLIE
72.306.25
25 cm



BRAUN
72.309.30
30 cm

74
Dermatologie
Dermatology
Dermatologie
Dermatologia
Dermatologia



KILNER
74.103.15
15 cm



SCHAMBERG
74.111.10
10 cm



UNNA
74.113.14
14 cm



UNNA
74.115.14
14 cm



WALTON
74.118.14
14 cm



SAALFELD
74.121.10
10 cm



mm	FOX
3	74.128.03
4	74.128.04
5	74.128.05
6	74.128.06



Fig.	PIFFARD
1	74.130.01
2	74.130.02
3	74.130.03

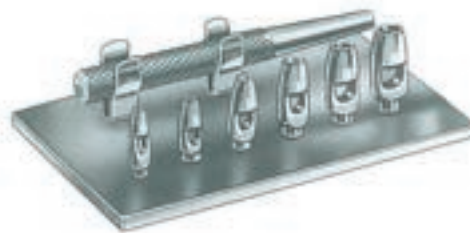

KEYES
74.138.00
compl.

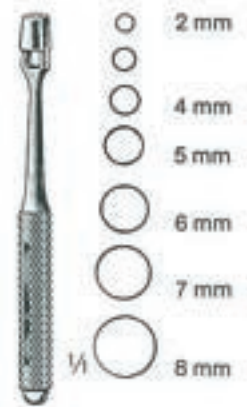

mm	KEYES
2	74.140.02
3	74.140.03
4	74.140.04
5	74.140.05
6	74.140.06
7	74.140.07
8	74.140.08

Hygiene
Hygiene
Hygiène
Higiene
Igiene



74.301.10



74.304.10 10 cm 74.305.10



74.331.14
14 cm



74.336.14
14 cm



cm TURNBULL
11,5 74.341.11
13,5 74.341.13



74.360.13
13 cm



74.365.11
11 cm



74.373.10
10,5 cm



74.378.10
10 cm



74.379.10
10 mm



cm
10 74.386.10
12 74.386.12



74.396.00
10 Ersatzklingen
10 Spare Blades
10 lames de rechange
10 hojas de repuesto
10 lame di ricambio

CREDO
74.395.14
14,5 cm

Verschiedene Behälter
 Different Containers
 Boîtes diverses
 Contenedores varios
 Vassoi diversi

18/10
 Edelstahl rostfrei
 Stainless Steel
 Acier inoxydable
 Acero inoxidable
 Acciaio inossidabile



SAUERBRUCH
 88.110.21
 210x125x17 mm



88.112.65
 65x15 mm



88.113.65



88.114.00
 150x95x13 mm



mm x mm x mm			
180	80	40	88.120.18
200	100	60	88.120.20
220	120	60	88.120.22
250	120	60	88.120.25
300	125	60	88.120.30
320	150	60	88.120.32
400	60	75	88.120.40
500	200	120	88.120.50

Instrumentenkästen
 Instrument Cases
 Boîtes à instruments
 Cajas para instrumentos
 Scatole per strumenti



mm x mm x mm			
140	80	50	88.124.14
170	120	60	88.124.17
200	60	40	88.124.20
220	100	50	88.124.22
220	140	80	88.124.23
270	170	60	88.124.27
300	180	65	88.124.30

Verschiedene Behälter
Different Containers
Boîtes diverses
Contenedores varios
Vassoi diversi

88



mm x mm		
100	100	88.125.10
120	120	88.125.12
150	150	88.125.15
180	180	88.125.18
200	200	88.125.20

18/10
Edelstahl rostfrei
Stainless Steel
Acier inoxydable
Acero inoxidable
Acciaio inossidabile



Ø mm	
40	88.130.04
60	88.130.06
80	88.130.08
100	88.130.10
120	88.130.12
150	88.130.15



mm x mm		l	
165	60	0,75	88.133.16
175	70	1,00	88.133.17
220	80	2,00	88.133.22
225	90	2,50	88.133.23
240	110	3,00	88.133.24
255	115	4,00	88.133.25
275	115	4,50	88.133.27
290	125	6,00	88.133.29
310	120	6,00	88.133.31
345	125	8,50	88.133.34
380	130	11,00	88.133.38
415	140	14,00	88.133.41



cm	
20	88.139.17
25*	88.139.25
27	88.139.27

* standard

Verschiedene Behälter
Different Containers
Boîtes diverses
Contenedores varios
Vassoi diversi

88

18/10
Edelstahl rostfrei
Stainless Steel
Acier inoxydable
Acero inoxidable
Acciaio inossidabile



l	
0,25	88.140.02
0,5	88.140.05
1,0	88.140.10
2,0	88.140.20



88.141.10
100x20 mm



mm x mm		
30 x 90		88.142.01
50 x 100		88.142.02
50 x 130		88.142.03
50 x 175		88.142.04
75 x 100		88.142.05
75 x 130		88.142.06
75 x 175		88.142.07
100 x 175		88.142.08
100 x 200		88.142.09



mm x mm x mm			
200	150	25	88.144.20
260	180	30	88.144.26
300	220	30	88.144.30
350	220	40	88.144.35

Instrumentenschalen
Instrument Trays
Plateaux à instruments
Bandejas para instrumentos
Bacinelle per strumenti



mm x mm x mm			
220	170	50	88.146.22
280	200	50	88.146.28
320	240	50	88.146.32
370	270	50	88.146.37
420	320	50	88.146.42

18/10
Edelstahl rostfrei
Stainless Steel
Acier inoxydable
Acero inoxidable
Acciaio inossidabile

Sterilisiertrommeln
Sterilizing Drums
Tambours à stérilisation
Tambores p. esterilización
Tambori p. sterilizzazione



SCHIMMELBUSCH	Ø x h mm x mm	KONRICH
88.152.08	125 x 80	88.182.08
88.152.10	125 x 100	88.182.10
88.152.12	125 x 125	88.182.12
88.155.08	150 x 80	
88.155.10	150 x 100	88.185.10
88.155.13	150 x 130	88.185.13
88.155.15	150 x 150	88.185.15
88.155.19	150 x 190	88.185.19
88.159.14	190 x 145	88.189.14
88.159.16	190 x 165	88.189.16
88.159.19	190 x 190	88.189.19
88.159.24	190 x 240	88.189.24
88.164.14	240 x 145	
88.164.16	240 x 165	88.194.16
88.164.19	240 x 190	88.194.19
88.164.24	240 x 240	88.194.24
88.164.29	240 x 290	88.194.29
88.164.34	240 x 340	
88.164.39	240 x 390	
88.169.14	290 x 145	88.199.14
88.169.16	290 x 165	88.199.16
88.169.19	290 x 190	88.199.19
88.169.24	290 x 240	88.199.24
88.169.29	290 x 290	88.199.29
88.169.34	290 x 340	
88.169.39	290 x 390	
88.174.14	340 x 145	88.204.14
88.174.16	340 x 165	88.204.16
88.174.19	340 x 190	88.204.19
88.174.24	340 x 240	88.204.24
88.174.29	340 x 290	88.204.29
88.174.34	340 x 340	
88.174.39	340 x 390	
88.179.14	390 x 145	88.209.14
88.179.16	390 x 165	88.209.16
88.179.19	390 x 190	88.209.19
88.179.24	390 x 240	88.209.24
88.179.29	390 x 290	88.209.29
88.179.34	390 x 340	88.209.34
88.179.39	390 x 390	88.209.39
88.179.49	390 x 490	
88.179.59	390 x 590	

Sterilisier-Siebschalen
Sterilization Trays
Plateaux à stérilisation
Bandejas de esterilización
Cestelli per sterilizzazione

18/10
Edelstahl rostfrei
Stainless Steel
Acier inoxydable
Acero inoxidable
Acciaio inossidabile

Aus Drahtgeflecht
Wire Mesh
En fil inox
De alambre
In rete metallica



cm x cm x cm

24 x 25 x 5	88.240.24
48 x 25 x 5	88.240.48
55 x 25 x 5	88.240.55
24 x 25 x 7	88.241.24
24 x 25 x 10	88.242.24
48 x 25 x 7	88.241.48
48 x 25 x 10	88.242.48

Aus perforiertem Blech
From Perforated Sheet Metal
En tôle perforée
De chapa de acero perforada
In acciaio perforato



cm x cm x cm

26 x 26 x 5	88.250.26
48 x 26 x 5	88.250.48
50,5 x 30,5 x 4	88.250.53

Sterilisier-Container und Zubehör auf Anfrage!
Sterilization Containers and Accessories, upon request.
Conteneurs pour la stérilisation et accessoires, sur demande.
Contenedores para la esterilización y accesorios, a solicitud.
Contentitori per la sterilizzazione e accessori, a richiesta.

Chirurgie-Instrumente
Surgical Instruments
Instruments de chirurgie
Instrumentos quirúrgicos
Strumenti per chirurgia

Hochfrequenz-Chirurgie
High Frequency Surgery
Chirurgie à haute fréquence
Electrocirugia
Electrochirurgia

Elektroden zum Schneiden und Koagulieren
Cutting and Coagulation Electrodes
Electrodes pour la coupe et la coagulation
Electrodos para cortar y para la coagulación
Elettrodi di taglio e di coagulazione

Serie MICRO + DENTAL



90.010.01
Fig. 1



90.010.02
Fig. 2
45°



90.010.03
Fig. 3
120°



90.010.11
Fig. 11
Ø 3 mm



90.010.12
Fig. 12
Ø 5 mm



90.010.13
Fig. 13
Ø 8 mm



90.010.14
Fig. 14



90.010.15
Fig. 15
7,0x1,5 mm
45°



90.010.16
Fig. 16
7 mm
45°



90.010.17
Fig. 17
6,0x1,3 mm



90.010.18
Fig. 18
7,0x1,7 mm
30°



90.010.21
Fig. 21
7,0x1,7 mm



90.010.31
Fig. 31
Ø 0,8 mm
45°



90.010.33
Fig. 33
Ø 1,7 mm
45°



90.010.34
Fig. 34
Ø 3,0 mm
45°



90.010.35
Fig. 35



90.010.36
Fig. 36
90°

Schaft - shaft - tige
vástago - asta
Ø 1,6 mm

Elektroden zum Schneiden und Koagulieren
Cutting and Coagulation Electrodes
Electrodes pour la coupe et la coagulation
Electrodos para cortar y para la coagulación
Elettrodi di taglio e di coagulazione

Serie MICRO + DENTAL

Hochfrequenz-Chirurgie
High Frequency Surgery
Chirurgie à haute fréquence
Electrochirurgia
Elettrochirurgia



90.011.51
Fig. 51
Ø 3 mm
45°



90.011.52
Fig. 52
7,0x1,7 mm
45°



90.011.53
Fig. 53
45°



90.011.54
Fig. 54



90.011.55
Fig. 55



90.011.56
Fig. 56
Ø 5 mm
45°



90.011.61
Fig. 61
45°



90.011.62
Fig. 62
90°

Schaft - shaft - tige
vástago - asta
Ø 4 mm

Serie STANDARD



90.020.01



90.020.02



90.020.03



90.020.04



Ø mm	
5	90.022.05
10	90.022.10
20	90.022.20



Ø mm	
10	90.024.10
15	90.024.15
20	90.024.20



Ø mm	
2	90.030.02
4	90.030.04
6	90.030.06

Schaft - shaft - tige
vástago - asta
Ø 4 mm

Bipolare Koagulation
Bipolar Coagulation
Coagulation bipolaire
Coagulación bipolar
Coagulazione bipolare

Handchirurgie, Ophthalmologie, Plastische Chirurgie, Experimentelle Chirurgie
Hand Surgery, Ophthalmology, Plastic Surgery, Experimental Surgery
Chirurgie de la main, Ophthalmologie, Chirurgie plastique, Chirurgie experimentale
Cirugia de la mano, Oftalmologia, Cirugia plastica, Cirugia experimental
Chirurgia della mano, Oftalmologia, Chirurgia plastica, Chirurgia sperimentale



Mikrochirurgie, HNO · Microsurgery, ENT · Microchirurgie, ORL · Microcirugia, ORL · Microchirurgia, ORL

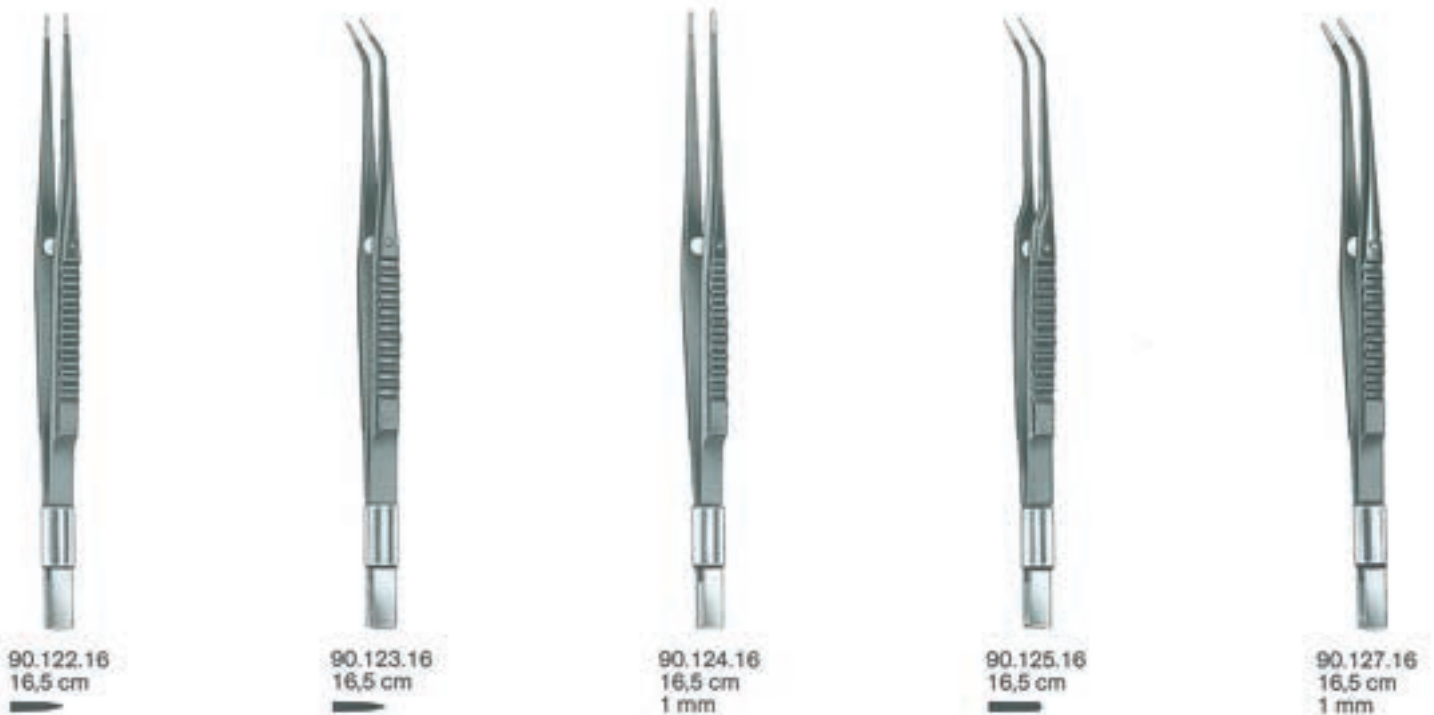

Bipolare Koagulation
Bipolar Coagulation
Coagulation bipolaire
Coagulación bipolar
Coagulazione bipolare

Mikrochirurgie, HNO · Microsurgery, ENT · Microchirurgia, ORL · Microcirugia, ORL · Microchirurgia, ORL



90.135.16
16,5 cm



90.139.16
16,5 cm



90.142.16
16,5 cm



90.144.16
16,5 cm



90.146.16
16,5 cm
1 mm

Gynäkologie, HNO, Tonsillen Chirurgie · Gynaecology, ENT, Tonsil Surgery · Gynécologie, ORL, Chirurgie des amygdales
Ginecología, ORL, Cirugía de amígdalas · Ginecologia, ORL, Chirurgia tonsillare



90.152.19
19,5 cm



90.154.19
19,5 cm
1 mm



90.157.19
19,5 cm
1 mm



90.159.19
19,5 cm
2 mm

90
Bipolare Koagulation
Bipolar Coagulation
Coagulation bipolaire
Coagulación bipolar
Coagulazione bipolare

Neurochirurgie · Neurosurgery · Neurochirurgie · Neurocirugía · Neurochirurgia



90.162.19
19,5 cm

90.164.19
19,5 cm
1 mm

90.166.19
19,5 cm
2 mm

90.167.19
19,5 cm
1 mm

90.169.19
19,5 cm
1 mm

90.172.03
0,3 mm

90.172.07
0,7 mm

90.172.12
1,2 mm

90.172.03-90.172.12
22,5 cm
0,3-1,2 mm

Bipolare Koagulation
Bipolar Coagulation
Coagulation bipolaire
Coagulación bipolar
Coagulazione bipolare

Anschlußkabel
Connection Cords
Cordons d'alimentation
Cables de conexión
Cavi da connessione



m				
3	90.190.30	90.191.30	90.192.30	90.193.30
5	90.190.50		90.192.50	90.193.50
	ERBE SELECT	AESCLAP	USA Mod.	MARTIN

HF-Chirurgie-Geräte
Electrosurgery Equipment
Electrobistouris
Electrobisturías
Elettrobisturi